

Hawke's Bay Irongate Industrial Area Modelling Report - Phase 2



Prepared by



April 2009

HAWKE'S BAY

Irongate Industrial Area Modelling

Phase 2



Prepared by **Matt Ellery**
Transportation Analyst

Eileen Ai
Transportation Analyst

Gabites Porter Consultants Ltd
Level 1, 138 Victoria Street
P O BOX 25 103
Christchurch
New Zealand

Reviewed by **David Hunter**
Senior Transport Engineer

Approved by **David Hunter**
Senior Transport Engineer

Telephone: +64 3 366 9871
Facsimile: +64 3 366 9870

Date: 14 April 2009
Reference: 4413
Status: Draft Report
Revision: 3/2a

CONTENTS

1. INTRODUCTION	1
2. ROAD NETWORKS	1
3. INDUSTRIAL LAND USE	4
4. MODELLING RESULTS	10

Tables

1. Irongate Future Development Scenarios	9
2. Irongate Development Future Landuse Assumptions	9

Figures

1. Hawke's Bay Base Road Network	2
2. Hawke's Bay Future Road Network	3
3. TRACKS zones distribution for Irongate Phase 1	5
4. TRACKS zones distribution for Irongate Phase 2	6
5. Areas subject to intensification	7
6. Development Stages for Irongate	8

1. INTRODUCTION

This report has been commissioned by MWHNZ Ltd on behalf of Hastings District Council and follows the Phase 1 report that showed the baseline traffic flows in the vicinity of the Irongate Industrial area in 2009 and 2016.

This Phase 2 report is an extension of the work completed in the Phase 1 report with modelling undertaken for 2016, 2021 and 2026. It includes base modelling for 2021 and 2026, staged industrial development over all of the modelled years as well as assessment of an additional access road to the Irongate industrial area.

The content of this report includes all changes made to the land use, zone system and road network during the 2009 model validation process. Refer to the Phase 1 report for details of these changes.

2. ROAD NETWORKS

The base road network used in the modelling is shown in **Figure 1** and the future road network with expressway extension is shown in **Figure 2**.

In the base network, Irongate Road is connected to Maraekakaho Road with a priority give way and there is a 4-leg roundabout at the Maraekakaho Road/Longlands Road/Paki Paki Road intersection.

The future road network has two separate options. In the first, the southern expressway extension has no connection to Irongate Road and in the second there is a link road between Irongate Road and York Road. In all options connection of the expressway extension to the Maraekakaho Road/Longlands Road/Paki Paki Road intersection, coloured orange, will be as a 5-leg roundabout. Irongate Road is straightened where it connects to Maraekakaho Road with a double approach give-way.

Should the Maraekakaho Road/York Road intersection fail with high delays at any stage it will be changed from a priority intersection to a roundabout.

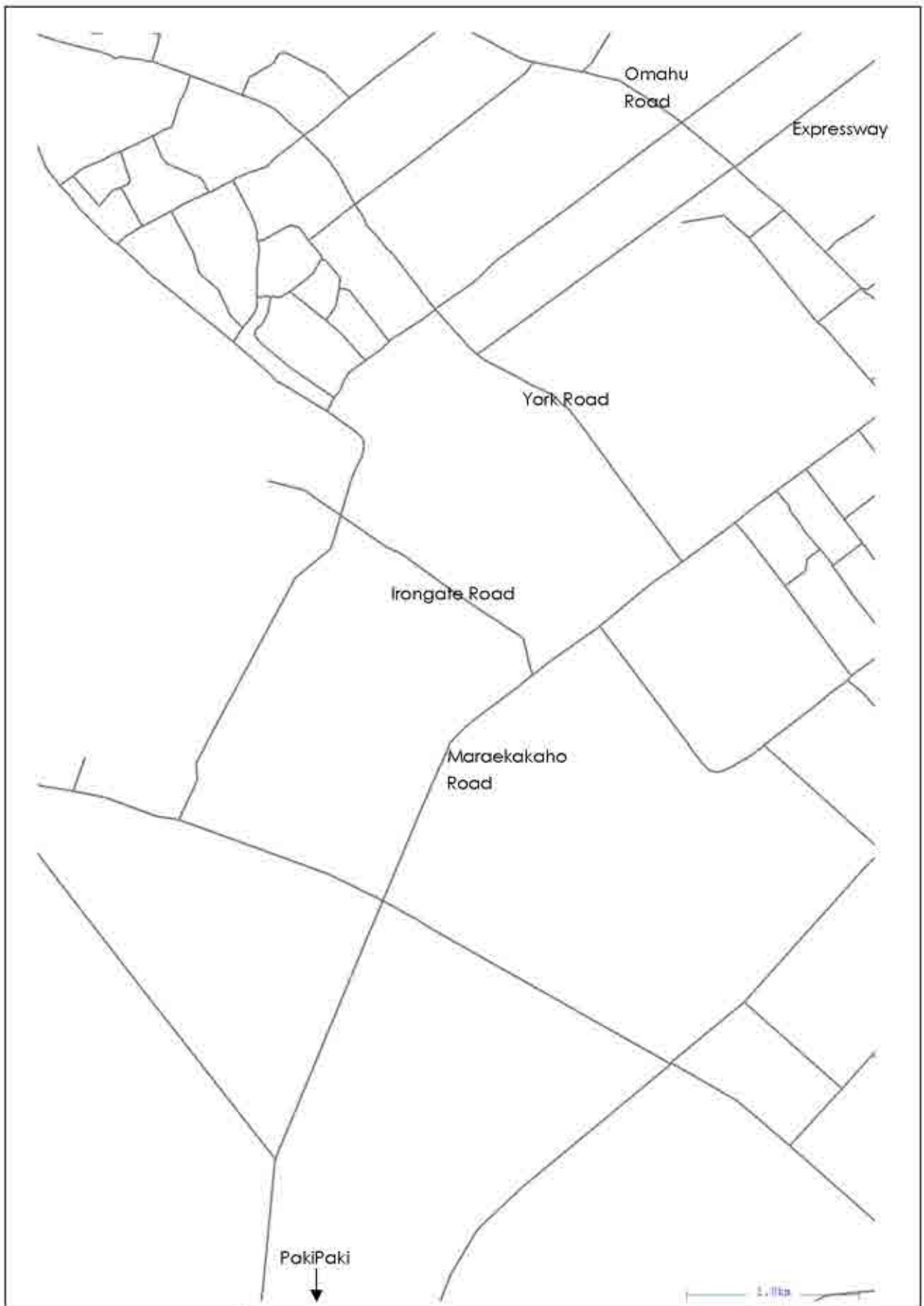

Hawke's Bay Irongate Modelling	Hawke's Bay Base Road Network	Figure 1
Gabites Porter Consultants		

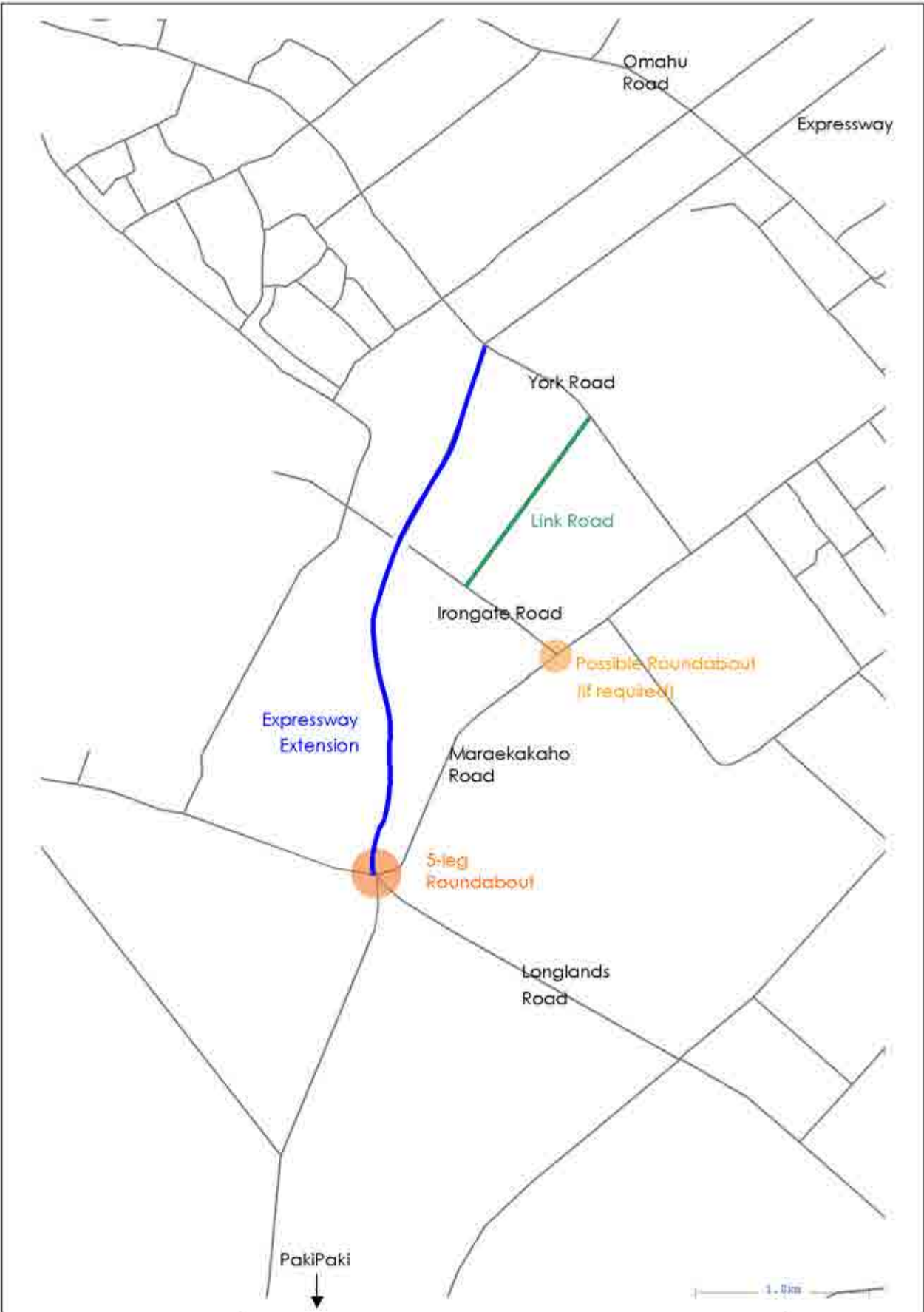

Hawke's Bay Irongate Modelling	Hawke's Bay Future Road Network	Figure 2
Gabites Porter Consultants		

3. INDUSTRIAL LAND USE

Industrial land use at Omaha and Tomoana has not been adjusted from previous analyses. Irongate Road industrial area has been based on previous analyses, which assumed 30% site coverage and $\frac{3}{4}$ of a trip per 100m², over a total area of 107 hectares.

The zone system that was used for Phase 1 of the modelling is shown in **Figure 3** and this has been extended for Phase 2 as shown in **Figure 4**. The base traffic generation attributed to the existing industrial activities are to be retained except for the areas indicated in **Figure 5** which are subject to intensification or to be treated as greenfields, as provided by MWH. These areas shall have the base traffic generation substituted with traffic generation determined in the same manner as the greenfields areas.

Development in the Irongate Industrial Area is to be modelled in stages as per the previous modelling detailed in Hawkes Bay Irongate Industrial Area Modelling Report (Jan 2009).

The Irongate Industrial Area Stage 1 covers an area of 48Ha, Stage 2 an area of 39Ha, and 20Ha of adjoining land subject to further consideration, as shown in **Figure 6**. Intermediate development stages are; Stage 1+ is Stage 1 (pink areas) plus extra adjoining areas (yellow), Stage 2 is Stage 1 (pink) plus extra adjoining areas (yellow) and half of Stage 2 (green), and Stage 2+ has all of the areas included. It has been indicated by MWH that 30% of industrial land will remain vacant, allowing for larger industries to land bank some areas for future growth and ensures that there is adequate land for further development available. As such, the modelling will assume 70% of the land area is occupied.

Irongate has a resulting combined development area of 34 ha for Stage 1, 48 ha for Stage 1+, 61 ha for Stage 2 and 74 ha for Stage 2+. The total jobs are derived based on the total area of developed land at each year, as has been used in the previous analyses but also allowing for the existing land use and areas subject to intensification, this means that the number of jobs per hectare does not change and remains constant.

Zones 152, 156, 159, 173,174 and 178 are made up of developments of Stage 1 as well as the areas subject to further consideration. In 2021 and 2026, residual jobs with Stage 2 development are distributed across the Stage 2 zones based on the area available.

Zones 160 and 172 (which are partially made up of Stage 1) and 177 represent the expansion of the Stage 2 development over 2021 and 2026.

All development scenarios run for Phase 2 are shown in **Table 1** below.

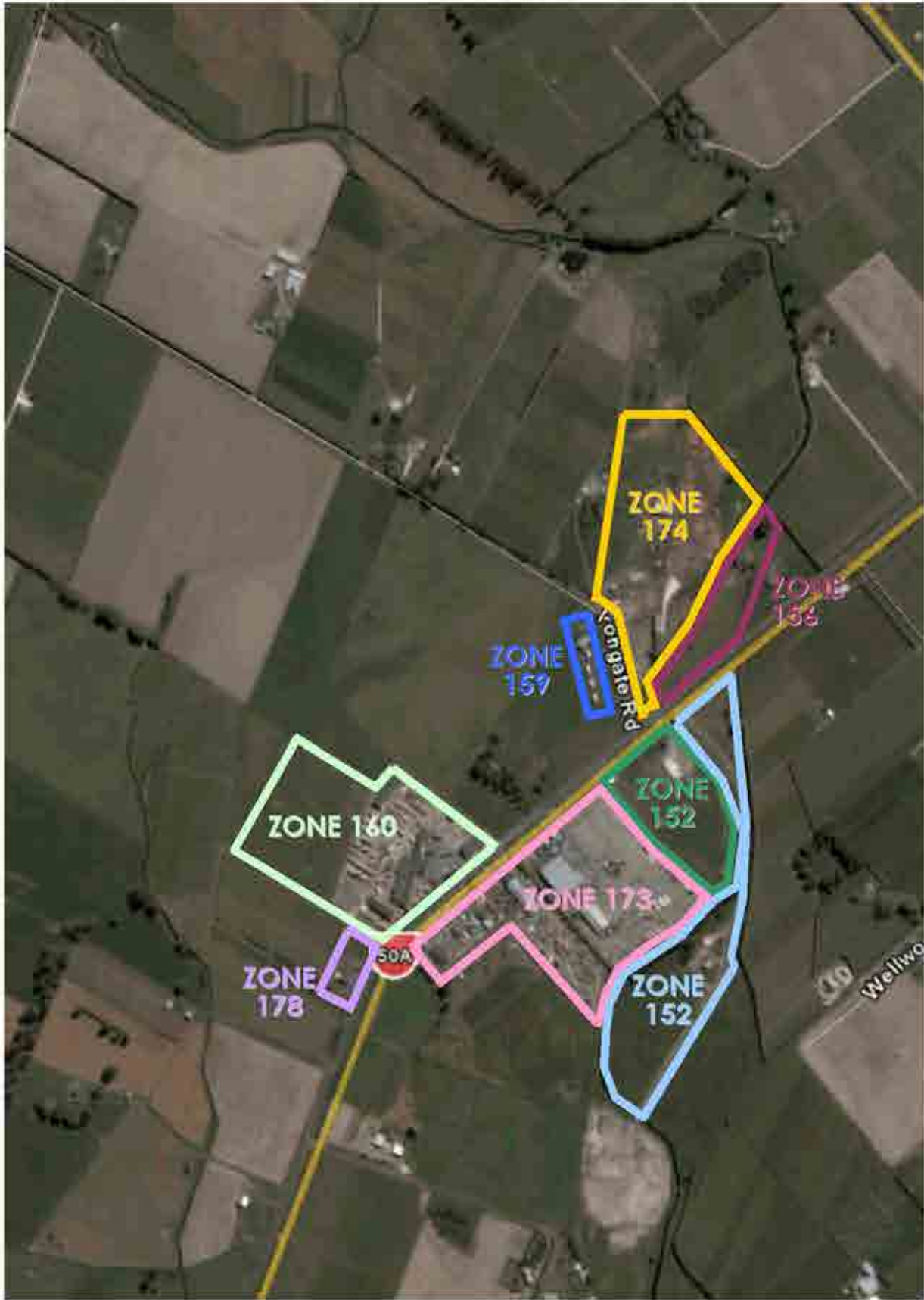

Hawke's Bay Irongate Modelling	TRACKS zones distribution for Irongate Phase 1	Figure 3
Gabites Porter Consultants		

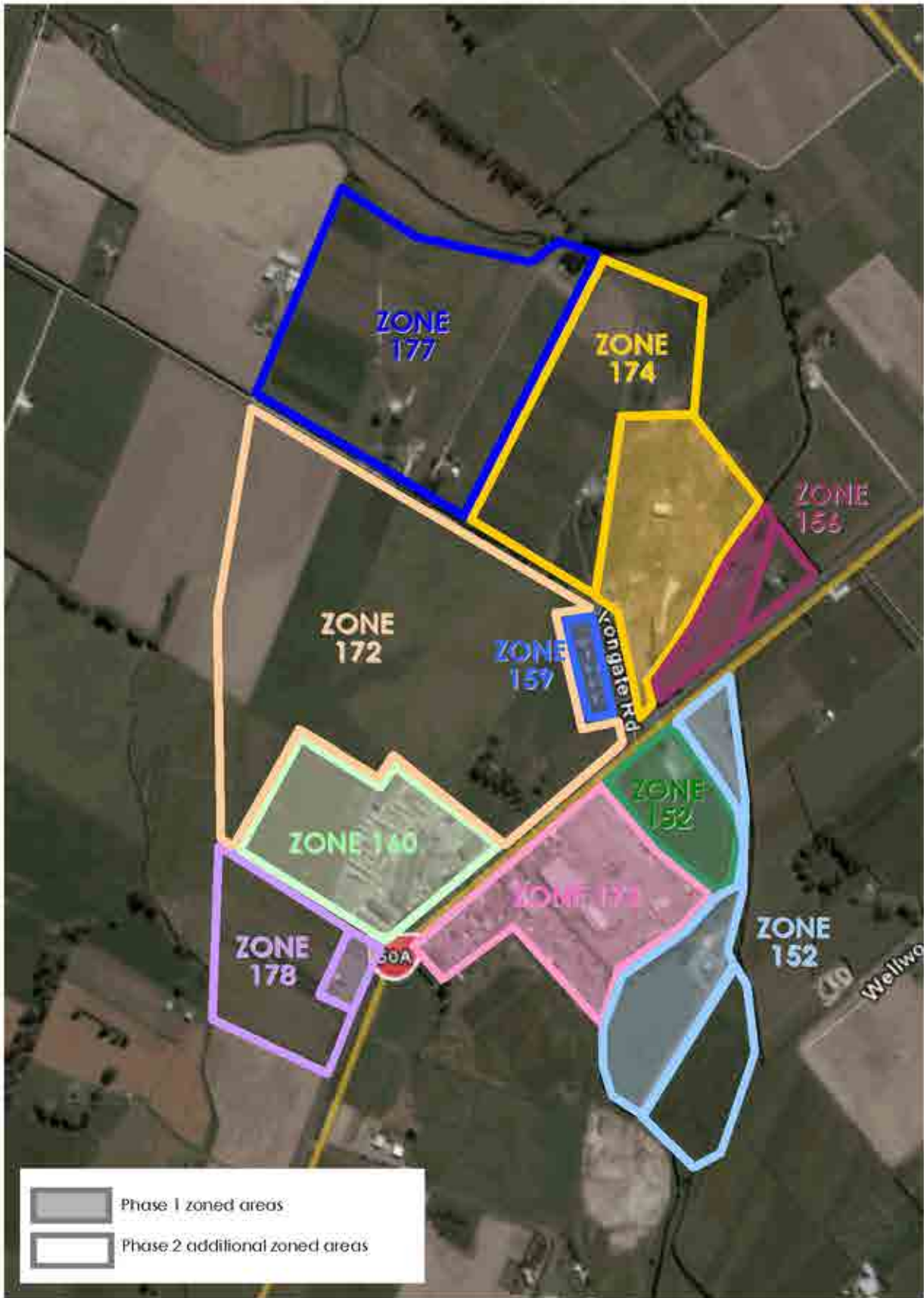

Hawke's Bay Irongate Modelling	TRACKS zones distribution for Irongate Phase 2	Figure 4
Gabites Porter Consultants		

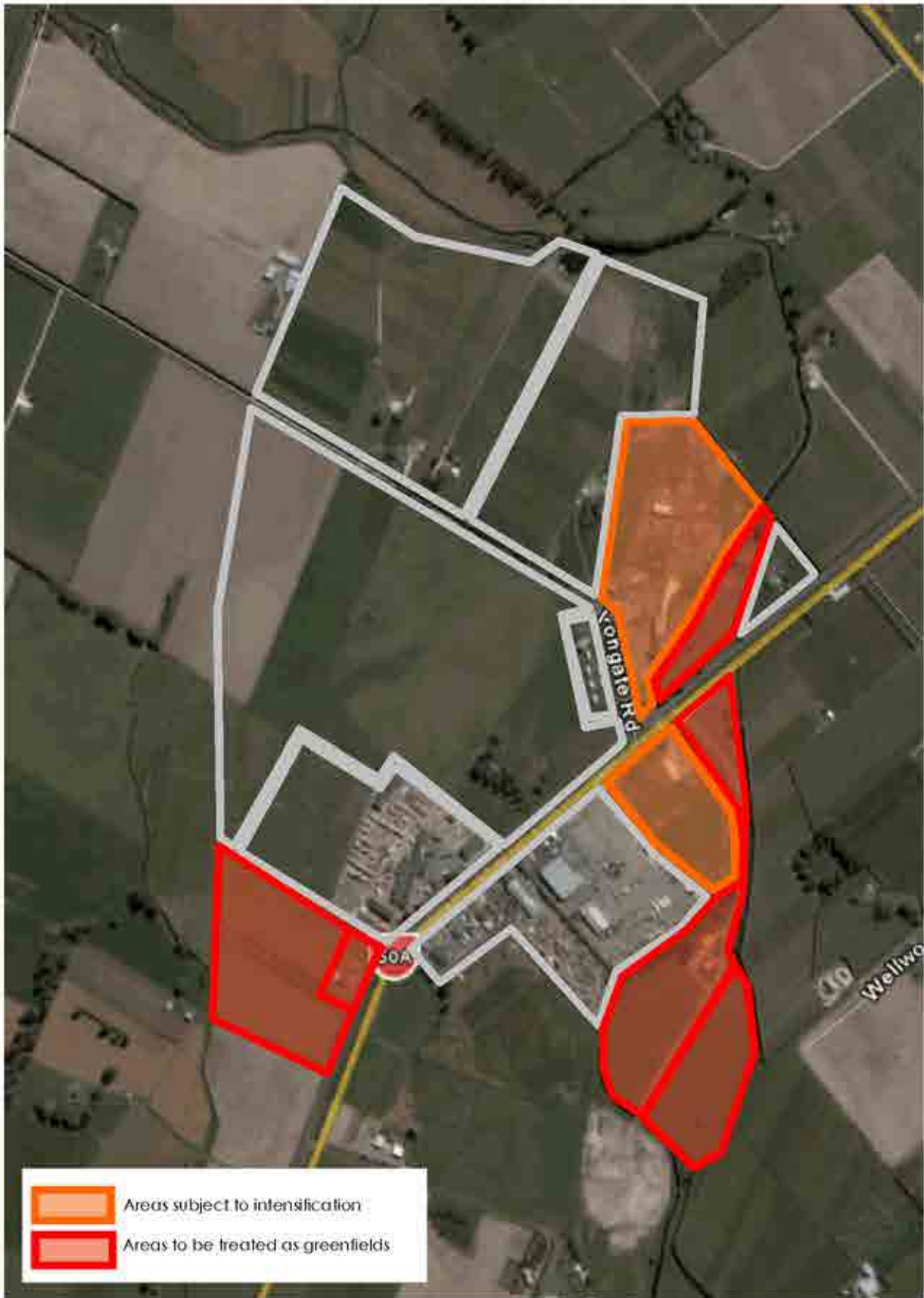

Hawke's Bay Irongate Modelling Gabites Porter Consultants	Areas subject to intensificaton	Figure 5
--	--	-----------------

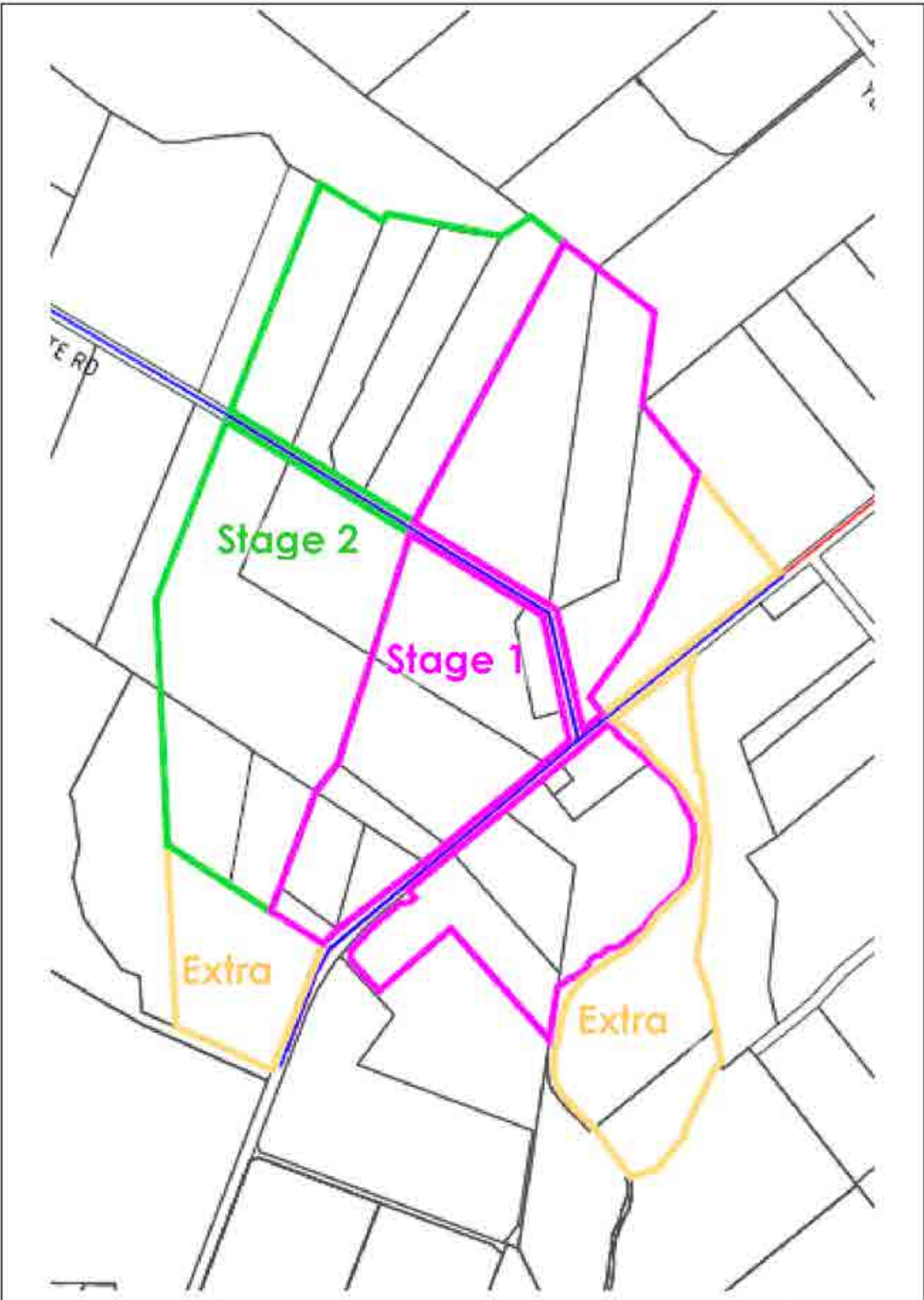

Hawke's Bay Irongate Modelling	Development Stages for Irongate	Figure 6
Gabites Porter Consultants		

Irongate Future Development Scenarios			Table 1
Year	Development Stage	Development Area	Zones for Development
2016	1	Pink	152, 159, 160, 172, 173, 174
	1+	Pink & yellow	152, 156, 159, 160, 172, 173, 174, 178
2021	1	Pink	152, 159, 160, 172, 173, 174
	1+	Pink & yellow	152, 156, 159, 160, 172, 173, 174, 178
	2	Pink & yellow & half green	152, 156, 159, 160, 172, 173, 174, 177, 178
2026	1	Pink	152, 159, 160, 172, 173, 174
	1+	Pink & yellow	152, 156, 159, 160, 172, 173, 174, 178
	2	Pink & yellow & half green	152, 156, 159, 160, 172, 173, 174, 177, 178
	2+	Pink & yellow & green	152, 156, 159, 160, 172, 173, 174, 177, 178

The total developed land area, total jobs and number of jobs by zone for the base and each stage of development are tabulated in **Table 2** below.

Irongate Development Future Landuse Assumptions					Table 2			
Landuse Variable		Base/Existing Areas			Development Stages			
		2016	2021	2026	Stage 1	Stage 1+	Stage 2	Stage 2+
Land Development (Ha)	Base	27	27	27	34	34	48	48
	Additional/ Stage 2	0	0	0	0	14	13	27
	TOTAL, Ha	27	27	27	34	48	61	74
Irongate Industrial Jobs	Zone 152	16	16	16	145	390	390	390
	Zone 156	7	7	7	7	84	84	84
	Zone 159	46	46	46	46	46	46	46
	Zone 160	115	115	115	115	115	115	115
	Zone 172	0	0	0	228	228	417	593
	Zone 173	120	120	120	120	120	120	120
	Zone 174	56	56	56	464	380	380	380
	Zone 177	0	0	0	0	0	189	344
	Zone 178	4	4	4	4	127	127	127
	Irongate, jobs	364	364	364	1129	1490	1868	2199
Other Industrial Jobs		2016		2021		2026		
		'Base'	Revised	'Base'	Revised	'Base'	Revised	
	Omahu	2332	2332	2579	2579	2826	2826	
	Tomoana	0	0	2490	2490	4979	4979	
	Total, jobs	2332	2332	5069	5069	7805	7805	

4. MODELLING RESULTS

Outputs for traffic volumes, levels of service (LOS) and change in volume to base can be seen in **Appendix 1** through **Appendix 11**.

At no stage did the Maraekakaho Rd/York Rd intersection show unacceptable level of service and therefore was not upgraded to a roundabout for any of the modelling undertaken. However, if this intersection is regarded as important, it is advised to put the modelled turning volumes from TRACKS into Sidra to gain a more accurate assessment of this intersection. While TRACKS is designed to replicate Sidra analysis as closely as possible, there may be some situations where there is an under-reporting of delays.

Appendix 1 contains the 2021 base network (existing Irongate land use only) plots in **Figure 1** through **Figure 9** and the 2026 base network (existing Irongate land use only) plots in **Figure 10** through **Figure 18**.

Appendix 2 contains 2016 Stage 1 Irongate developments (including existing land use). The base Irongate development plots are in **Figure 1** through **Figure 9** and with link road in **Figure 10** through **Figure 18**.

Appendix 3 contains 2016 Stage 1+ Irongate developments (including existing land use). The base Irongate development plots are in **Figure 1** through **Figure 9** and with link road in **Figure 10** through **Figure 18**.

Appendix 4 contains 2021 Stage 1 Irongate developments (including existing land use). The base Irongate development plots are in **Figure 1** through **Figure 9** and with link road in **Figure 10** through **Figure 18**.

Appendix 5 contains 2021 Stage 1+ Irongate developments (including existing land use). The base Irongate development plots are in **Figure 1** through **Figure 9** and with link road in **Figure 10** through **Figure 18**.

Appendix 6 contains 2021 Stage 2 Irongate developments (including existing land use). The base Irongate development plots are in **Figure 1** through **Figure 9** and with link road in **Figure 10** through **Figure 18**.

Appendix 7 contains 2021 Stage 2+ Irongate developments (including existing land use). The base Irongate development plots are in **Figure 1** through **Figure 9** and with link road in **Figure 10** through **Figure 18**.

Appendix 8 contains 2026 Stage 1 Irongate developments (including existing land use). The base Irongate development plots are in **Figure 1** through **Figure 9** and with link road in **Figure 10** through **Figure 18**.

Appendix 9 contains 2026 Stage 1+ Irongate developments (including existing land use). The base Irongate development plots are in **Figure 1** through **Figure 9** and with link road in **Figure 10** through **Figure 18**.

Appendix 10 contains 2026 Stage 2 Irongate developments (including existing land use). The base Irongate development plots are in **Figure 1** through **Figure 9** and with link road in **Figure 10** through **Figure 18**.

Appendix 11 contains 2026 Stage 2+ Irongate developments (including existing land use). The base Irongate development plots are in **Figure 1** through **Figure 9** and with link road in **Figure 10** through **Figure 18**.

REFERENCES

- Akcelik Akcelik, R., Travel Time Functions for Transportation Planning Purposes. Australian Road Research, 21(3), September 1991.
- Akcelik Akcelik, R., The Highway Capacity Manual Formula for Signalised Intersections. ITE Journal, March 1988, Vol. 58, No. 3.
- Fisk Fisk, C.S., Link Travel Time Functions for Traffic Assignment.
Department of Civil Engineering, University of Auckland.
- Fisk Fisk, C.S., and Tan H.H., Delay Analysis for Priority Intersections.
Department of Civil Engineering, University of Auckland, 1989.
- Gabites Porter Performance Analysis of Priority Intersections - A Practitioner's Guide, September 1991
- Gabites Porter Hawkes Bay Irongate Industrial Area Modelling Report, January 2009
- Gabites Porter Hawkes Bay Irongate Industrial Area Modelling Report – Phase 1, March 2009
- Land Transport NZ Project Evaluation Manual, October 2005.



APPENDICES

APPENDIX 1

2021 and 2026 Base Model:

- Old 2021 and 2026 Base plus Existing Irongate LU and Expressway Extension

1. 2021 AM Peak Base Traffic Volumes	1
2. 2021 SH Peak Base Traffic Volumes	2
3. 2021 PM Peak Base Traffic Volumes	3
4. 2021 AM Peak Base Change in Traffic Volumes	4
5. 2021 SH Peak Base Change in Traffic Volumes	5
6. 2021 PM Peak Base Change in Traffic Volumes	6
7. 2021 AM Peak Base Level of Service	7
8. 2021 SH Peak Base Level of Service	8
9. 2021 PM Peak Base Level of Service	9
10. 2026 AM Peak Base Traffic Volumes	10
11. 2026 SH Peak Base Traffic Volumes	11
12. 2026 PM Peak Base Traffic Volumes	12
13. 2026 AM Peak Base Change in Traffic Volumes	13
14. 2026 SH Peak Base Change in Traffic Volumes	14
15. 2026 PM Peak Base Change in Traffic Volumes	15
16. 2026 AM Peak Base Level of Service	16
17. 2026 SH Peak Base Level of Service	17
18. 2016 PM Peak Base Level of Service	18

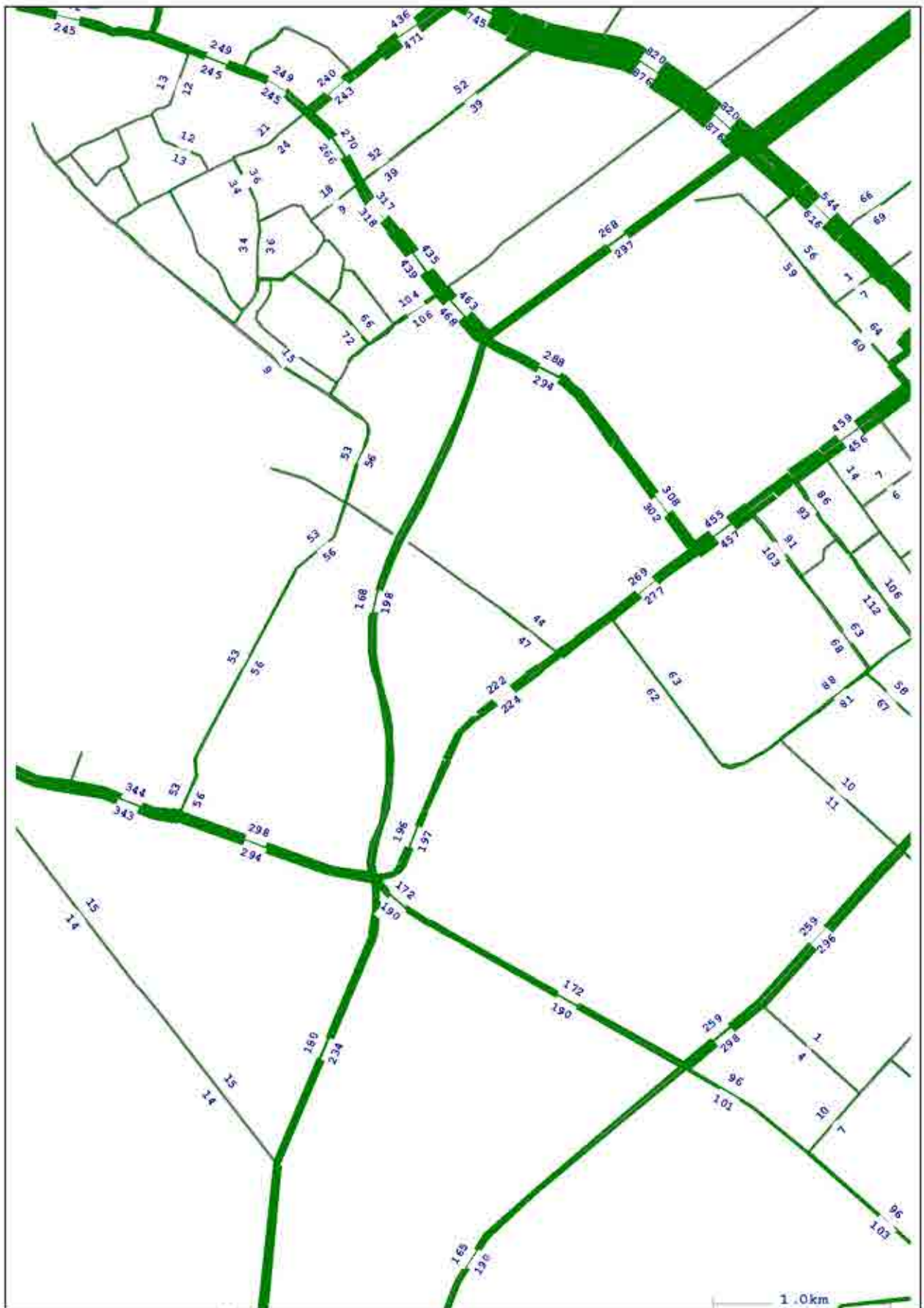

Hawke's Bay Ingate Modelling	2021 SH Peak Base Traffic Volumes	Figure 2
Gabites Porter Consultants		

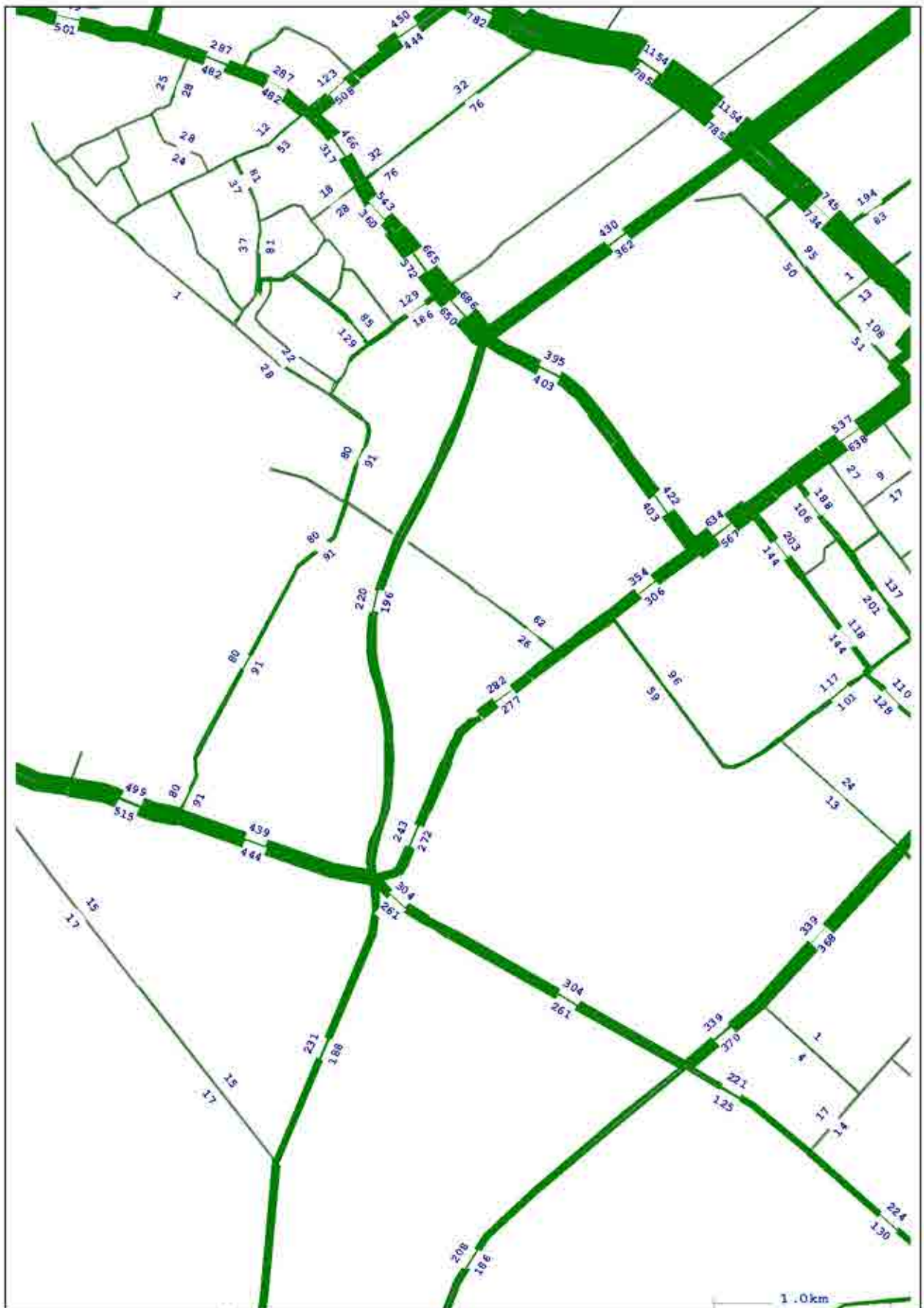

Hawke's Bay Irongate Modelling	2021 PM Peak Base Traffic Volumes	Figure 3
Gabites Porter Consultants		

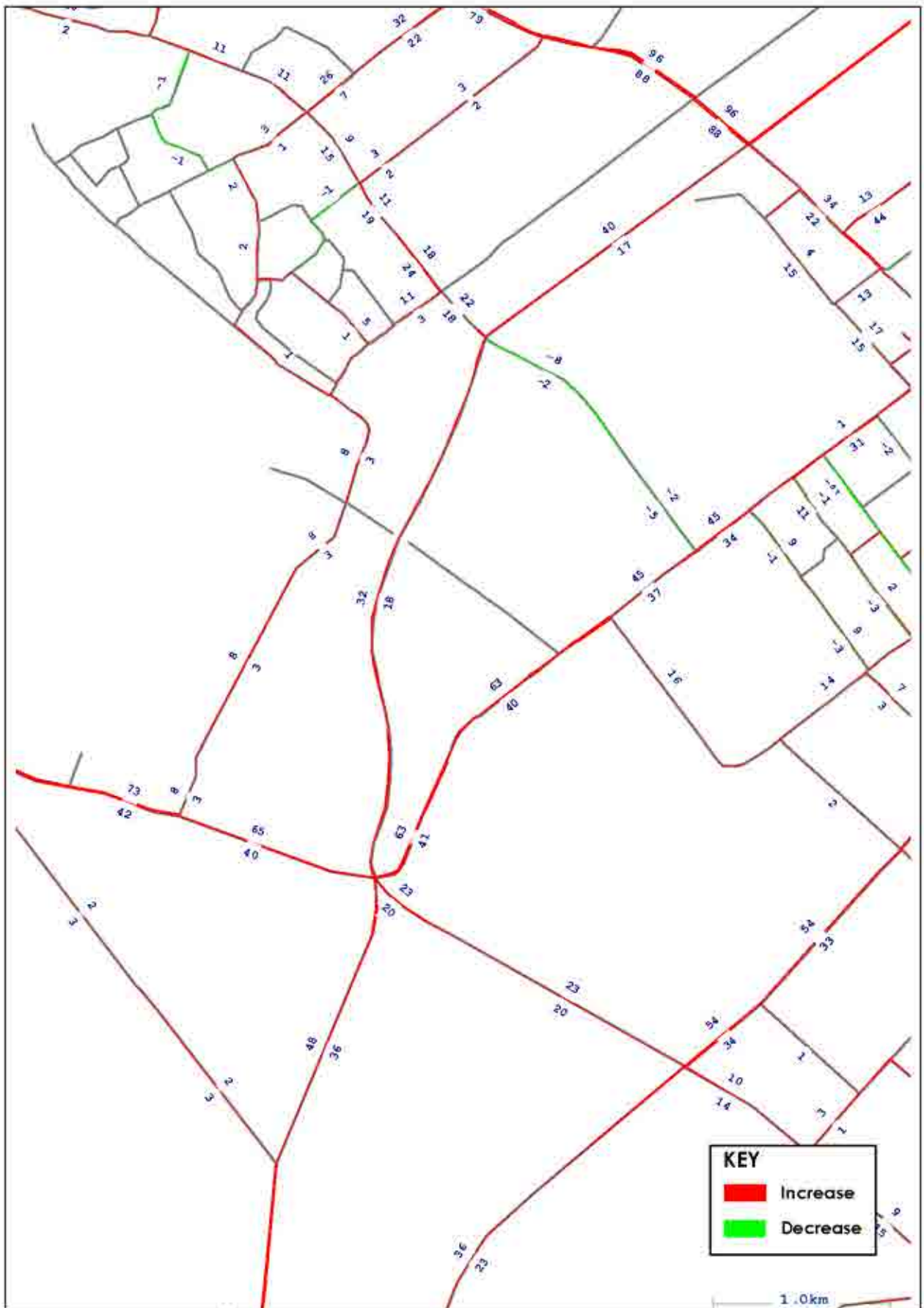

Hawke's Bay Irongate Modelling	2021 AM Peak Base Change in Traffic Volumes	Figure 4
Gabites Porter Consultants		

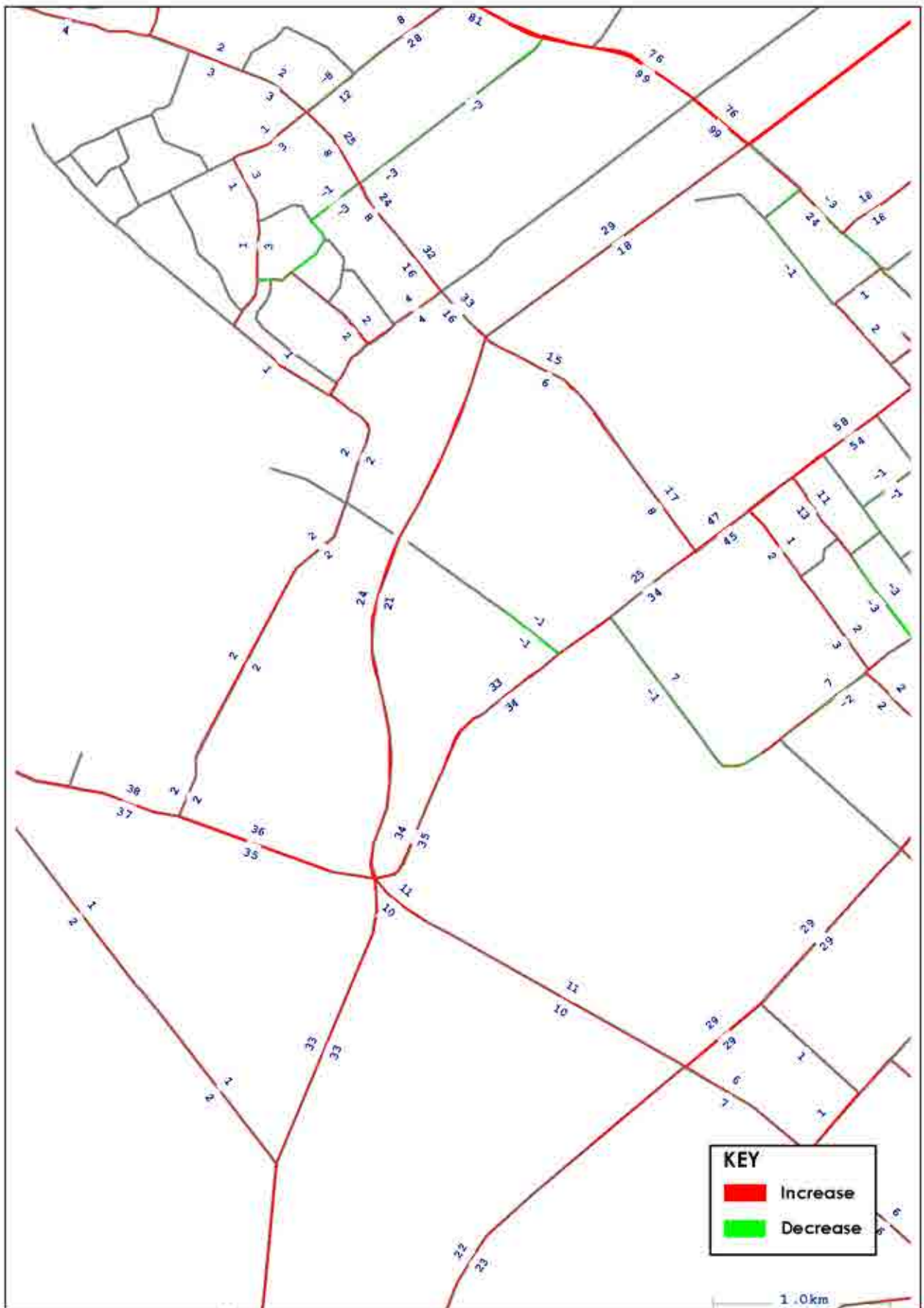

Hawke's Bay Irongate Modelling Gabites Porter Consultants	2021 SH Peak Base Change in Traffic Volumes	Figure 5
--	---	-----------------

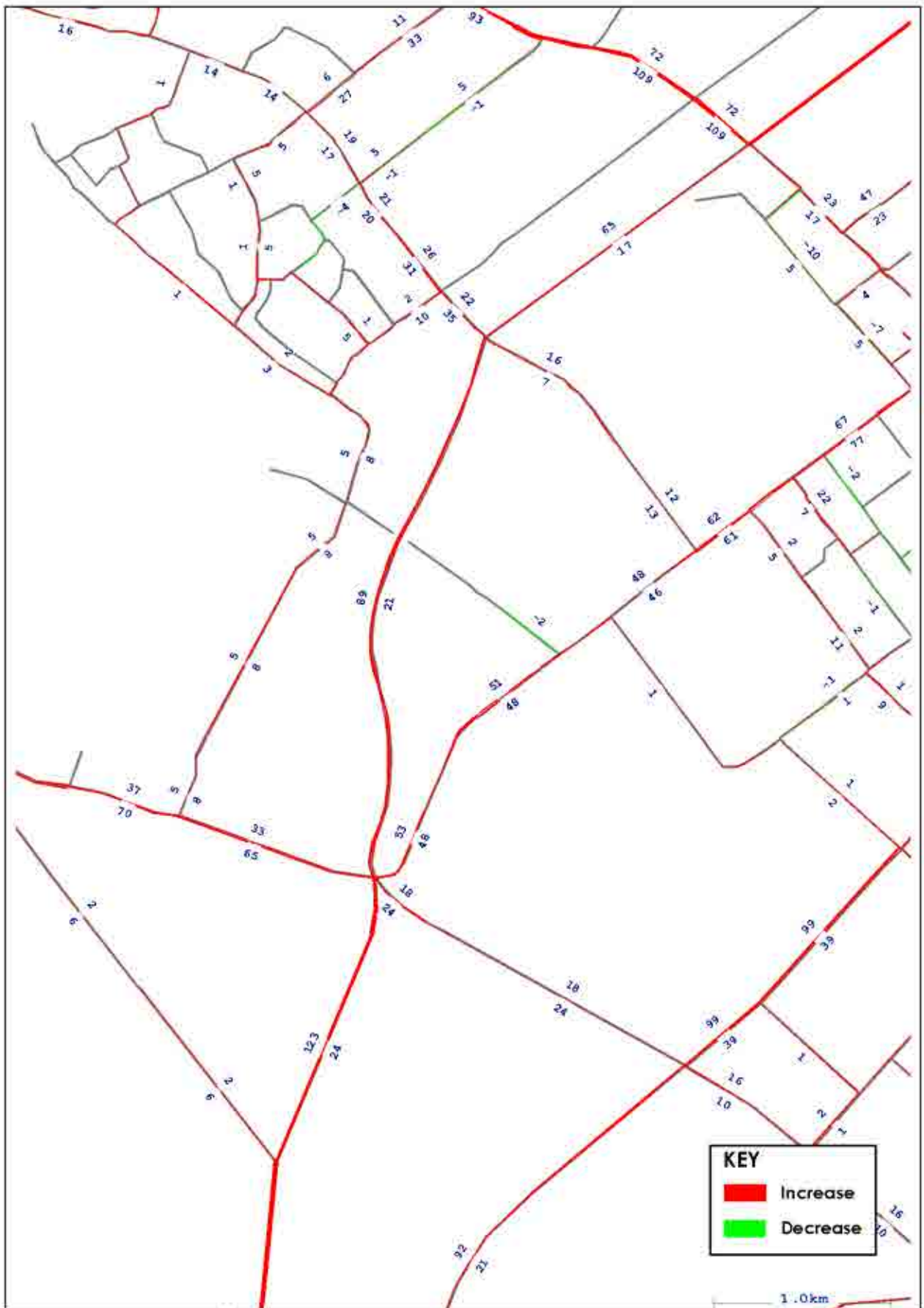

Hawke's Bay Inrgate Modelling Gabites Porter Consultants	2021 PM Peak Base Change in Traffic Volumes	Figure 6
---	---	-----------------

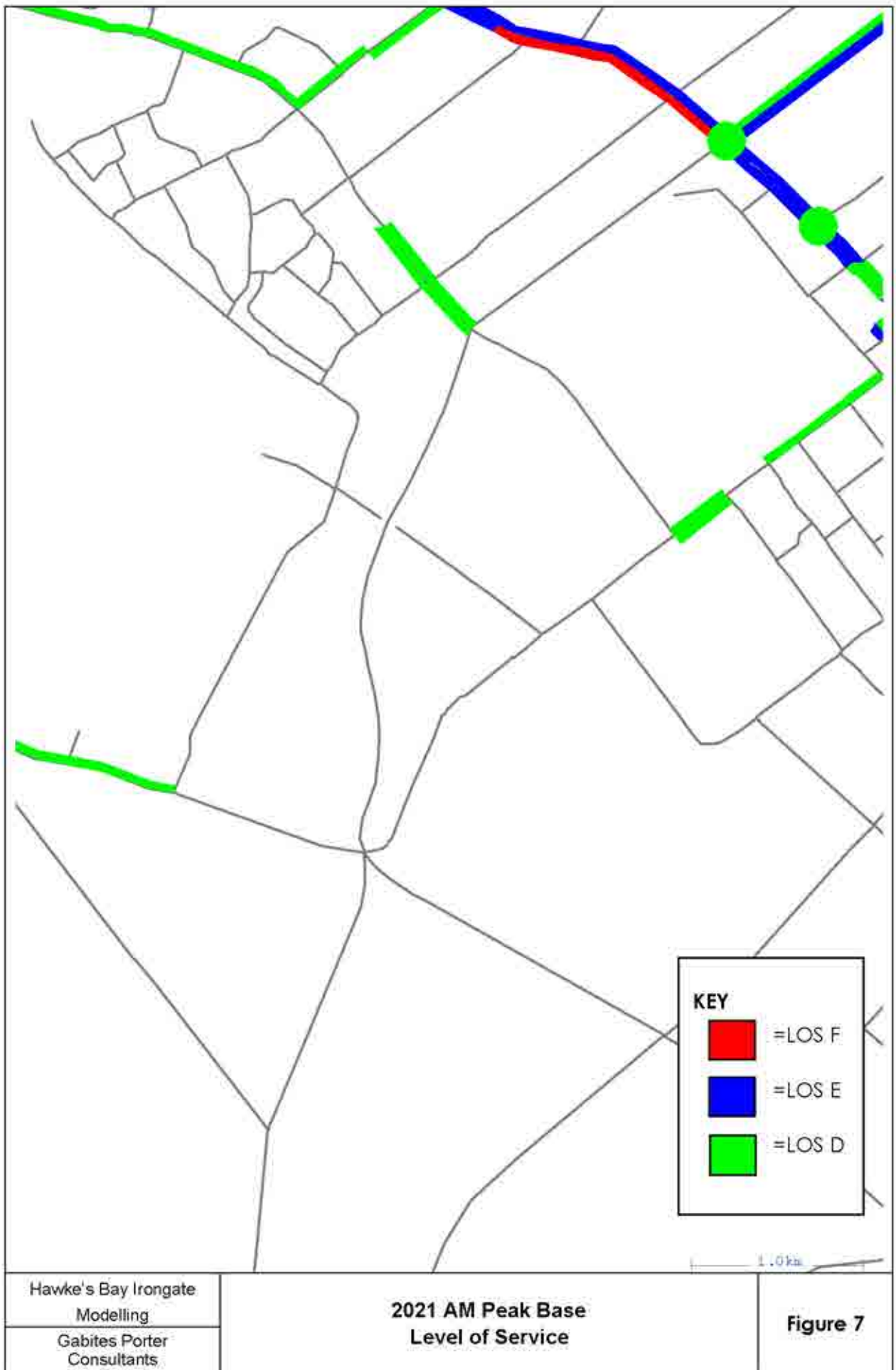

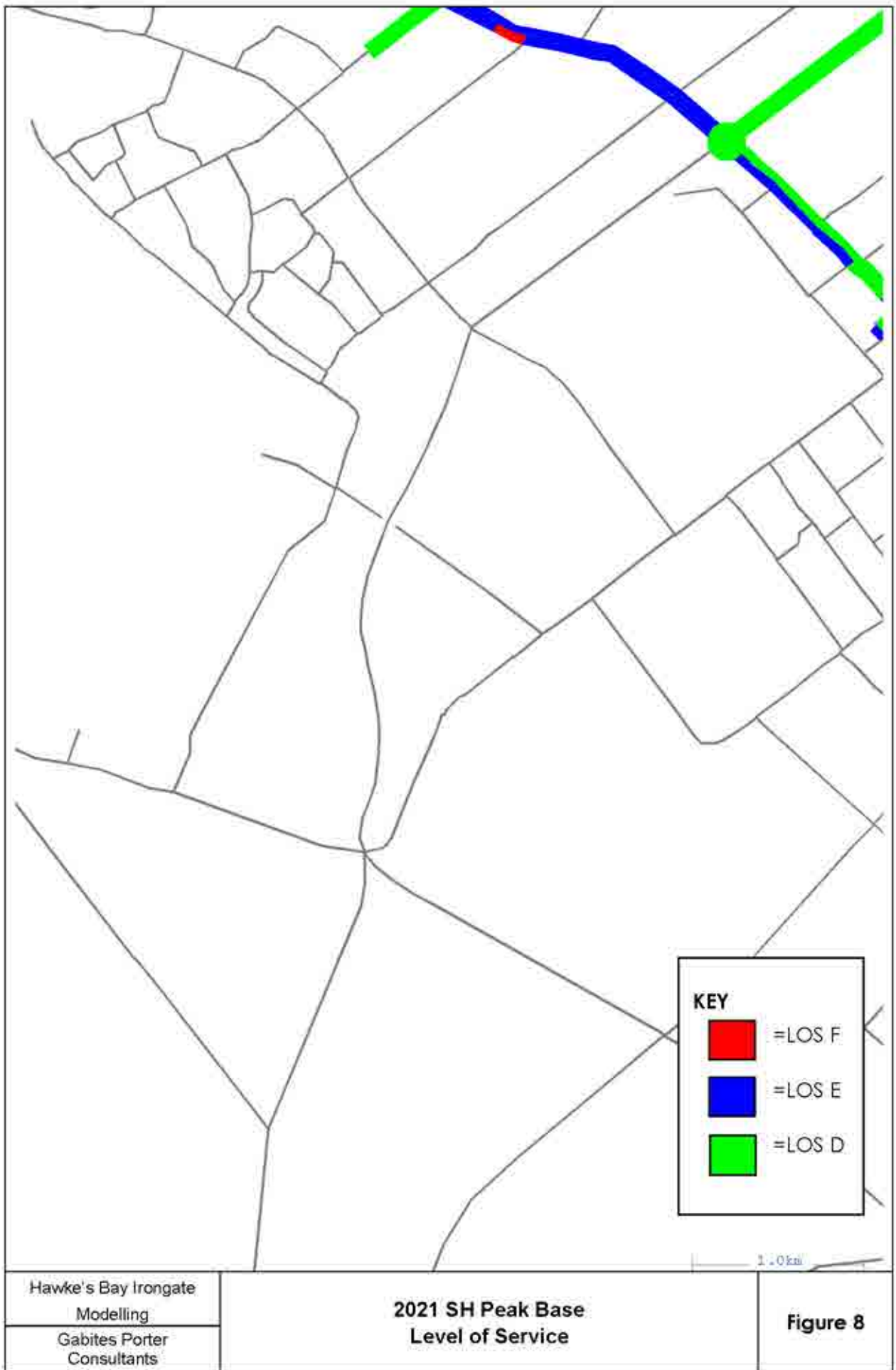

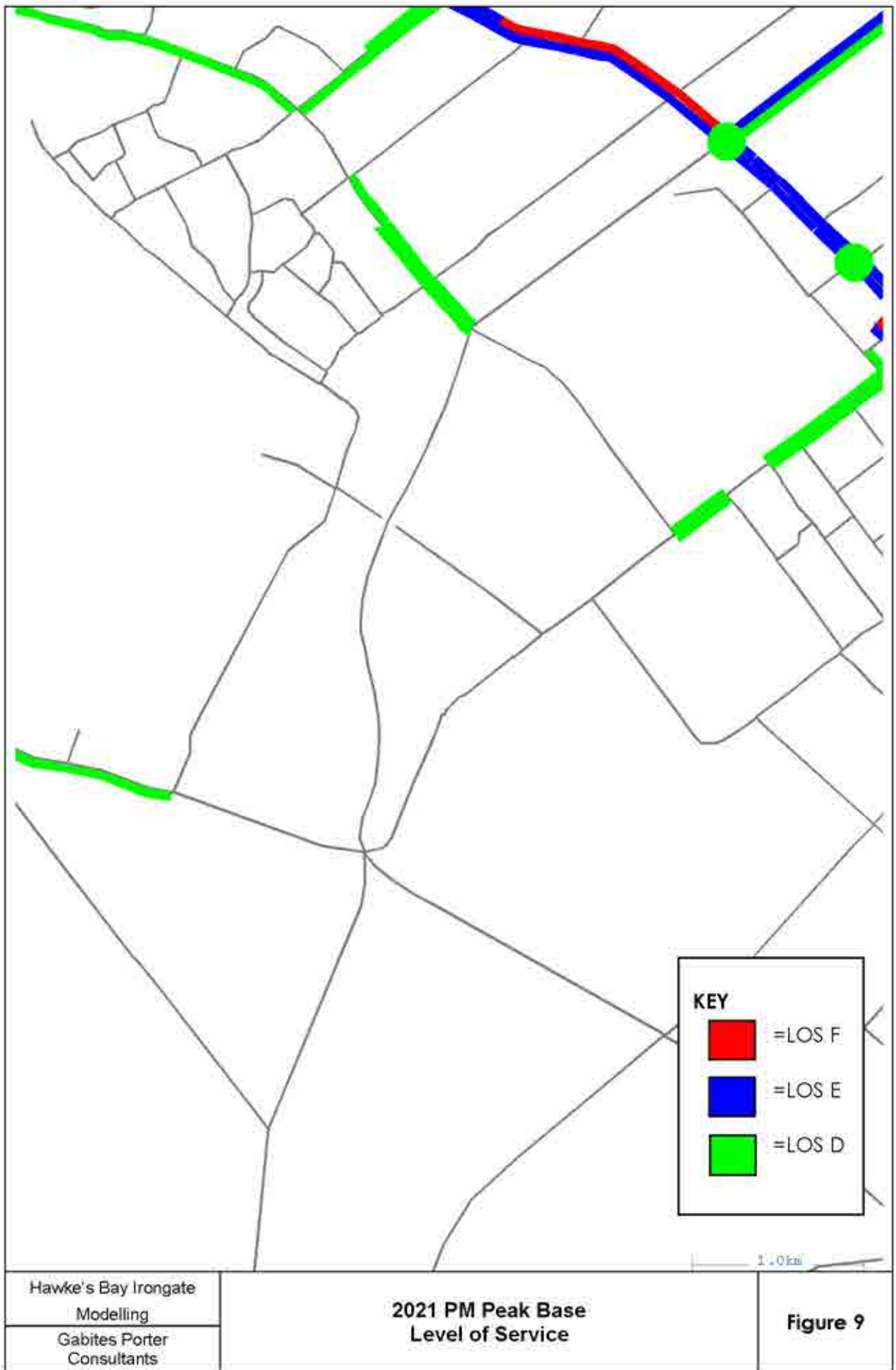

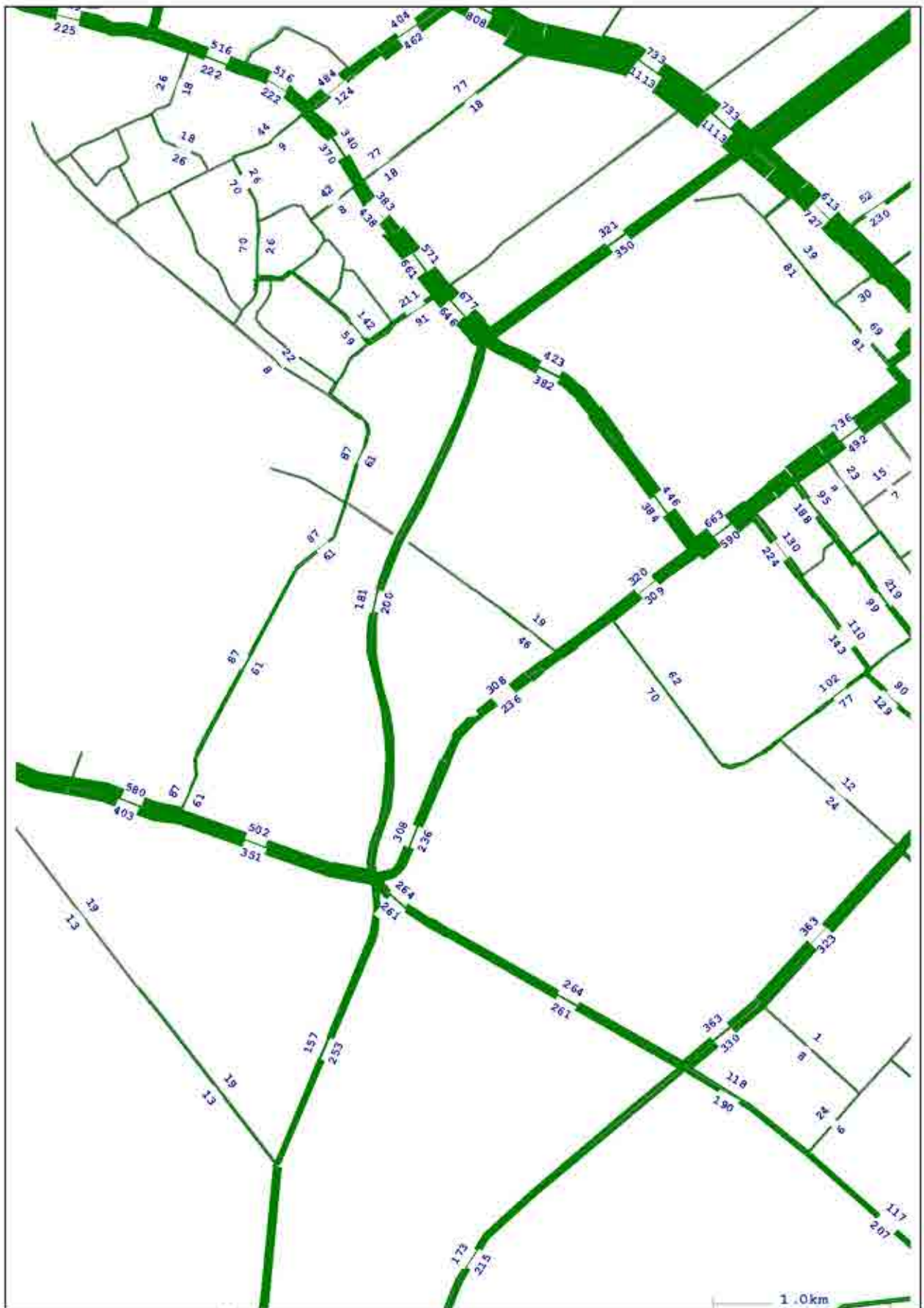

Hawke's Bay Inrogate Modelling	2026 AM Peak Base Traffic Volumes	Figure 10
Gabites Porter Consultants		

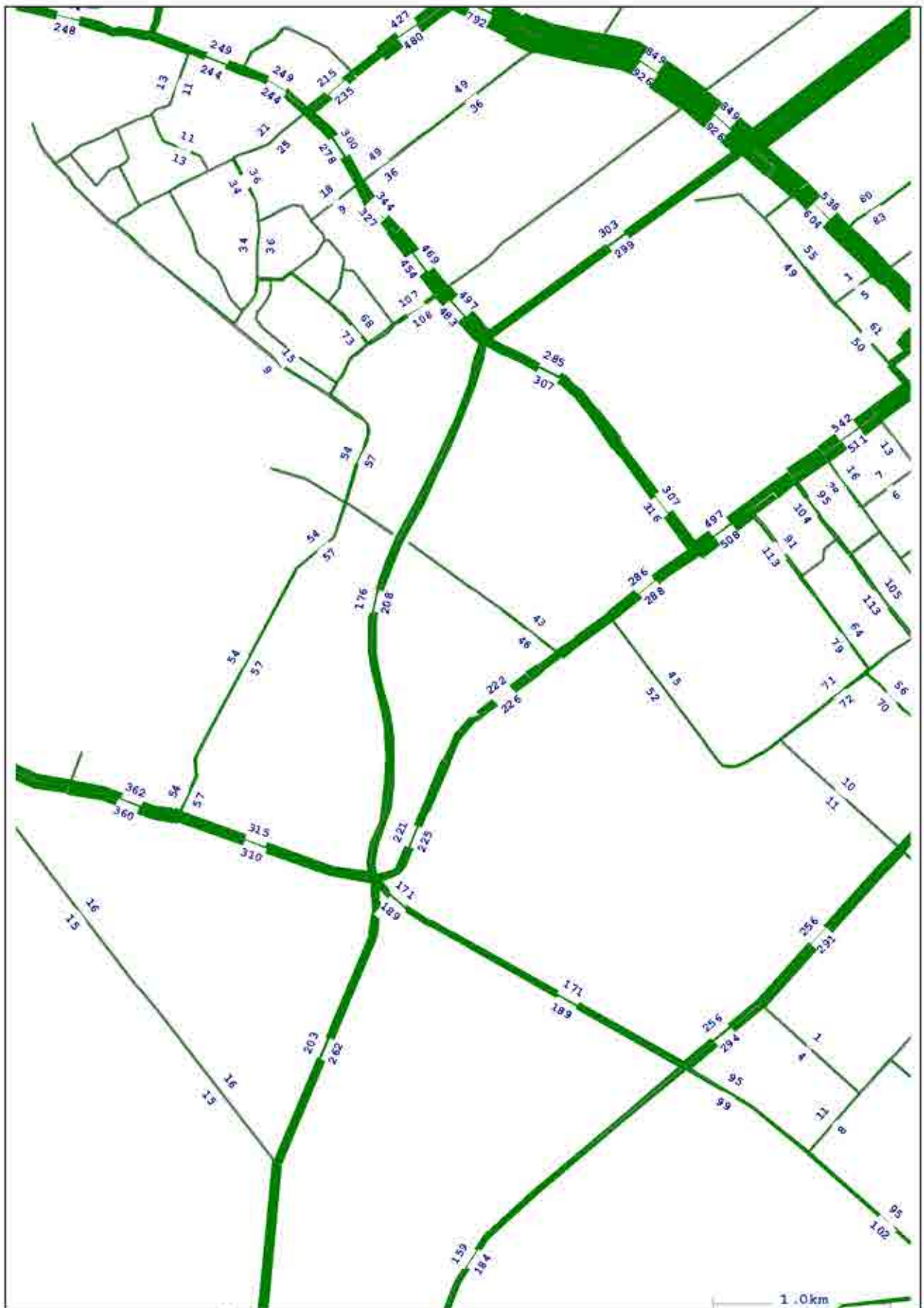

Hawke's Bay Ingate Modelling	2026 SH Peak Base Traffic Volumes	Figure 11
Gabites Porter Consultants		

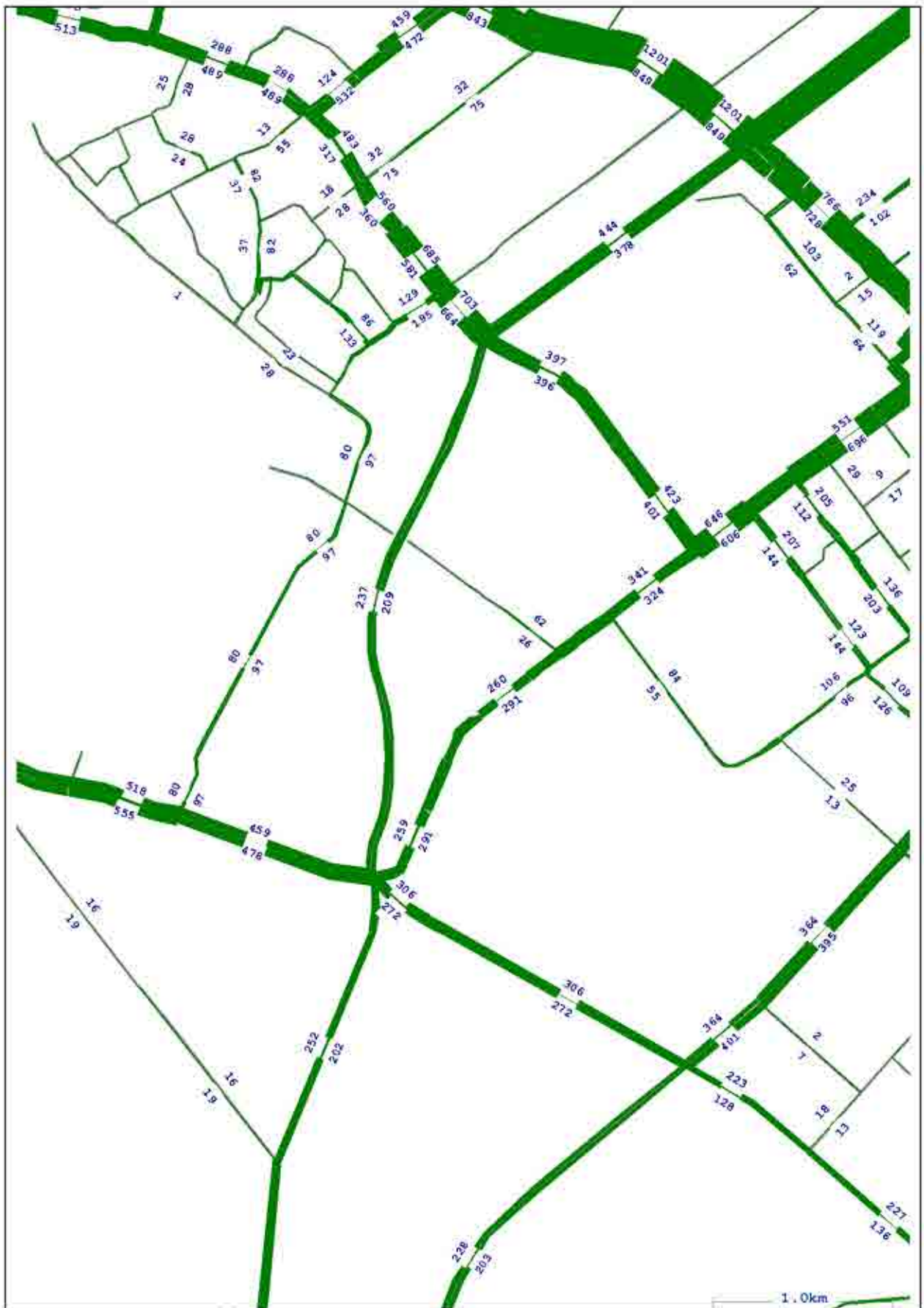

Hawke's Bay Inrgate Modelling Gabites Porter Consultants	2026 PM Peak Base Traffic Volumes	Figure 12
---	---	------------------

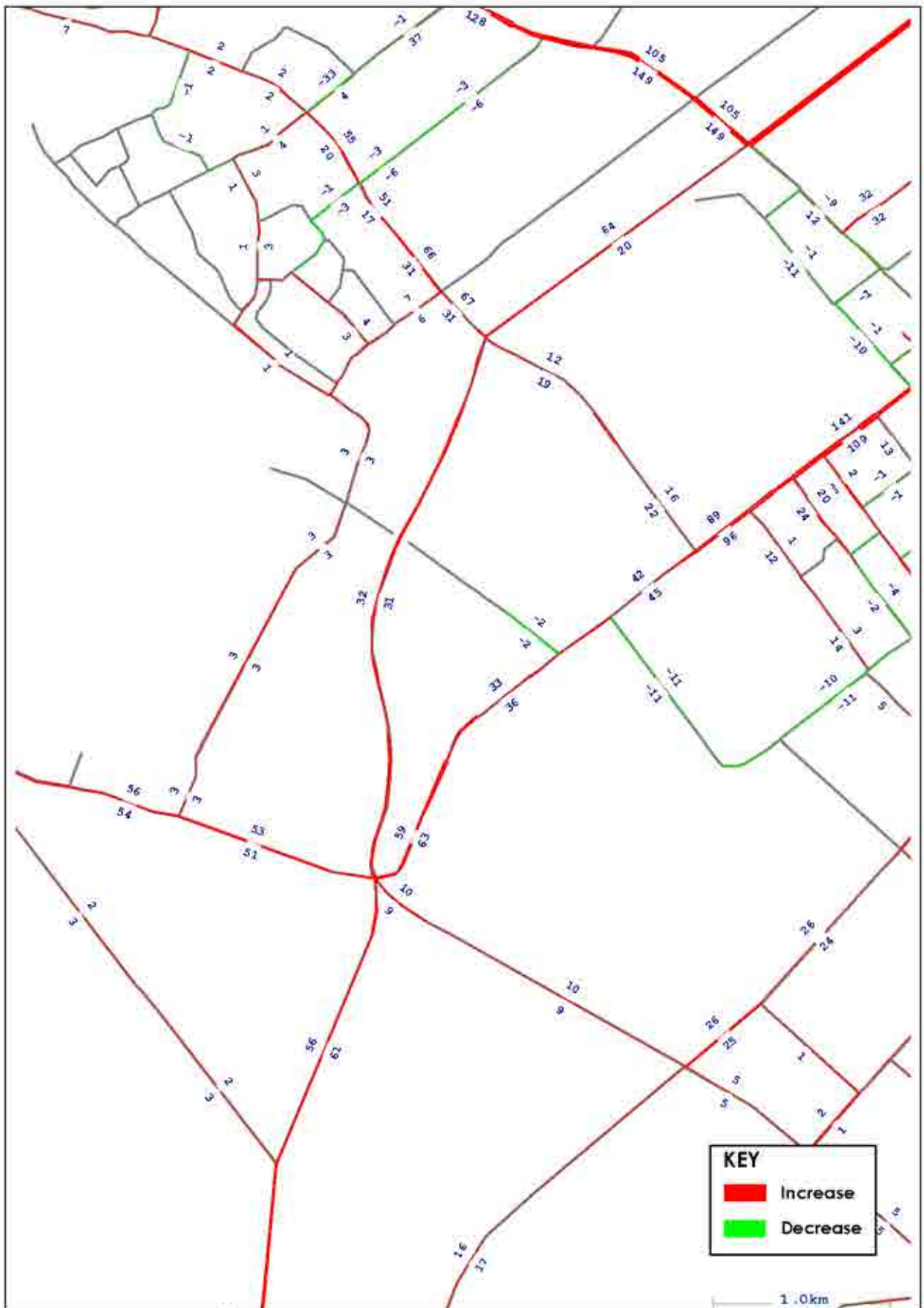

Hawke's Bay Irongate Modelling	2026 SH Peak Base Change in Traffic Volumes	Figure 14
Gabites Porter Consultants		

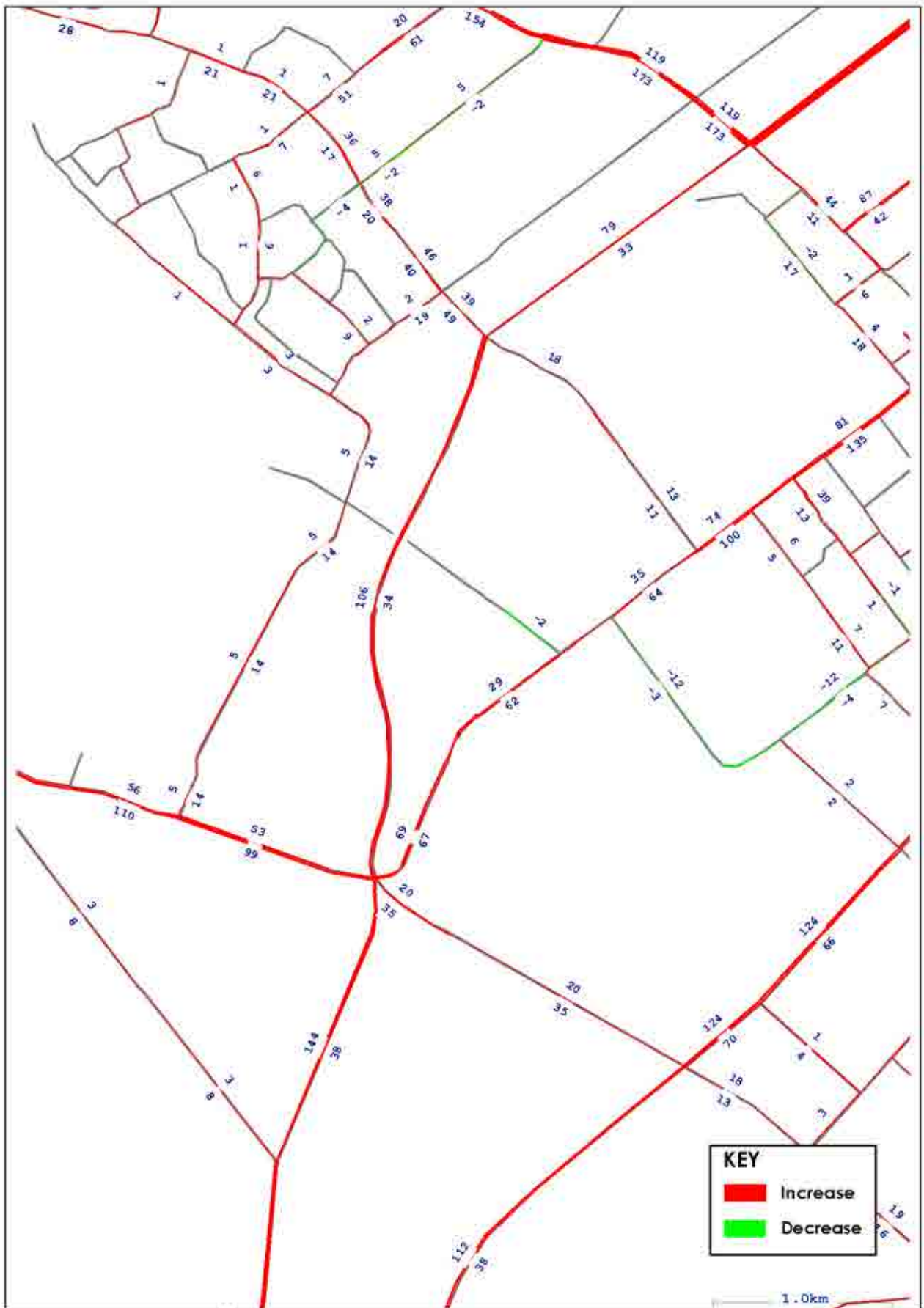

Hawke's Bay Irongate Modelling Gabites Porter Consultants	2026 PM Peak Base Change in Traffic Volumes	Figure 15
--	---	------------------

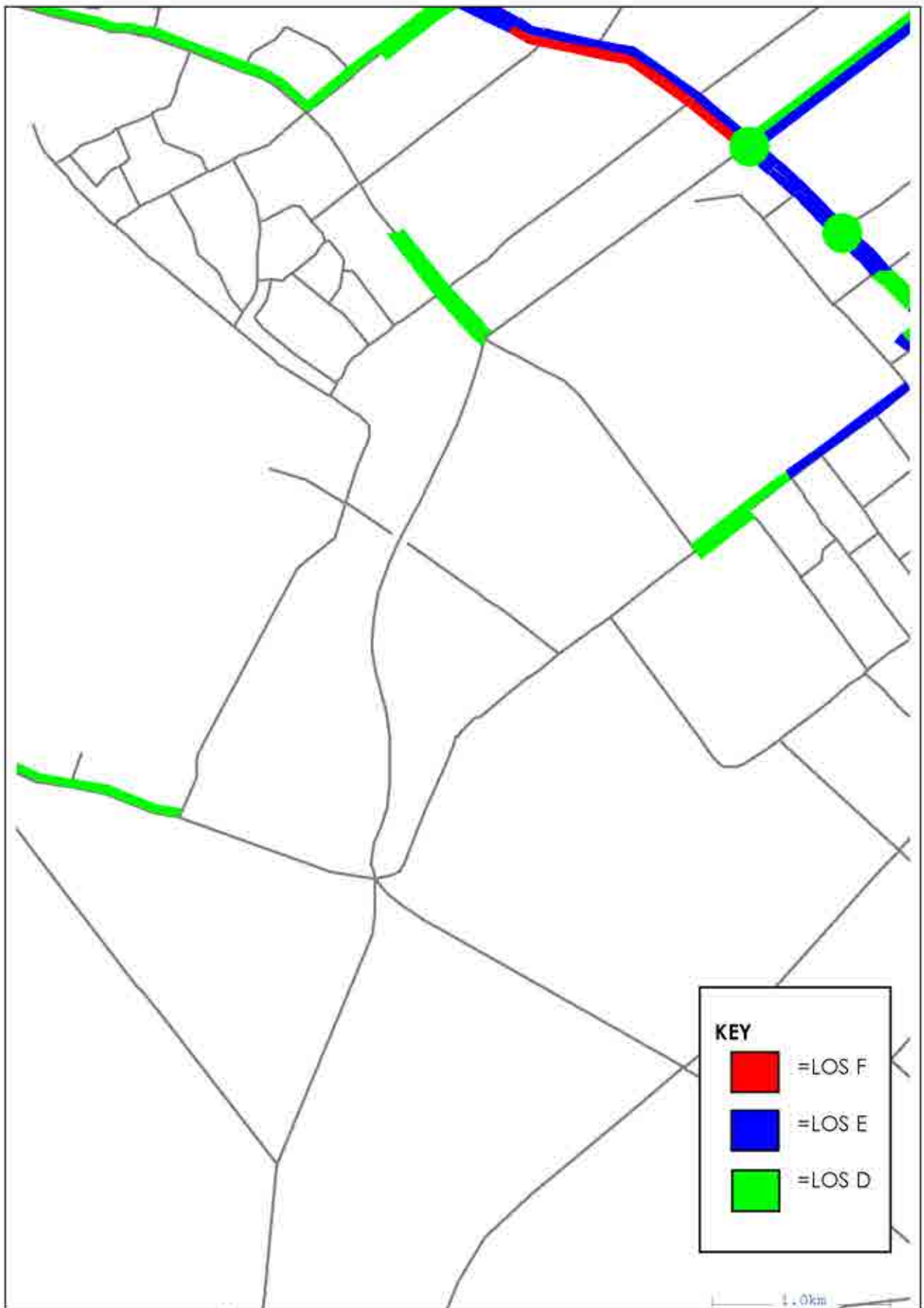

Hawke's Bay Irongate Modelling Gabites Porter Consultants	2026 AM Peak Base Level of Service	Figure 16
--	--	------------------



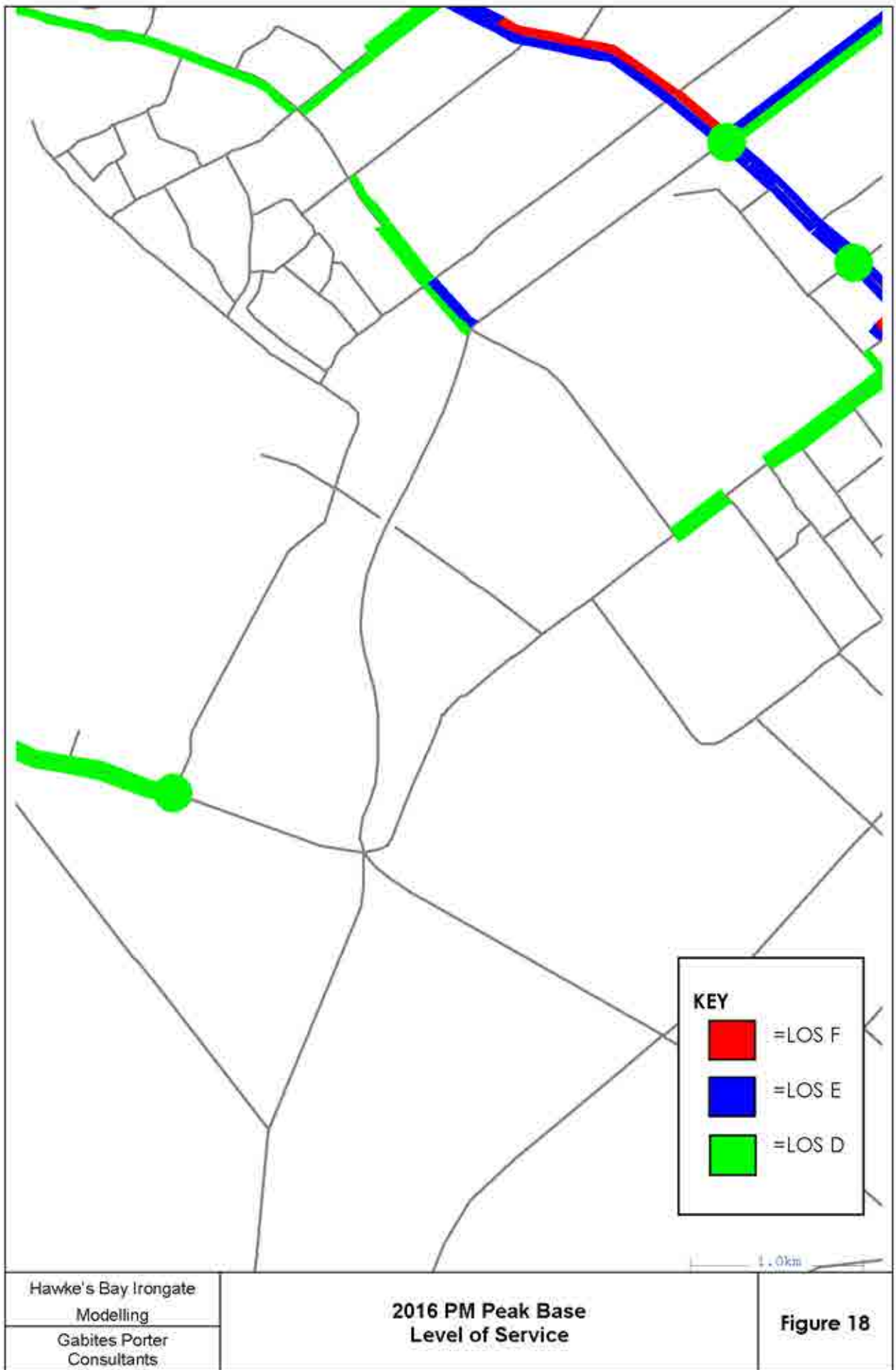

APPENDIX 2

2016 Stage 1:

- With Irongate development
- With Irongate + York Rd Link with Irongate Rd
- With Irongate + Left turn off expressway into Irongate Rd

1.	2016 AM Peak Irongate Stage 1 Development Traffic Volumes	1
2.	2016 SH Peak Irongate Stage 1 Development Traffic Volumes	2
3.	2016 PM Peak Irongate Stage 1 Development Traffic Volumes	3
4.	2016 AM Peak Irongate Stage 1 Development Change in Traffic Volumes to 2016 Base	4
5.	2016 SH Peak Irongate Stage 1 Development Change in Traffic Volumes to 2016 Base	5
6.	2016 PM Peak Irongate Stage 1 Development Change in Traffic Volumes to 2016 Base	6
7.	2016 AM Peak Irongate Stage 1 Development Level of Service	7
8.	2016 SH Peak Irongate Stage 1 Development Level of Service	8
9.	2016 PM Peak Irongate Stage 1 Development Level of Service	9
10.	2016 AM Peak Irongate with Link Road Stage 1 Development Traffic Volumes	10
11.	2016 SH Peak Irongate with Link Road Stage 1 Development Traffic Volumes	11
12.	2016 PM Peak Irongate with Link Road Stage 1 Development Traffic Volumes	12
13.	2016 AM Peak Irongate with Link Road Stage 1 Development Change in Traffic Volumes to 2016 Base	13
14.	2016 SH Peak Irongate with Link Road Stage 1 Development Change in Traffic Volumes to 2016 Base	14
15.	2016 PM Peak Irongate with Link Road Stage 1 Development Change in Traffic Volumes to 2016 Base	15
16.	2016 AM Peak Irongate with Link Road Stage 1 Development Level of Service	16
17.	2016 SH Peak Irongate with Link Road Stage 1 Development Level of Service	17
18.	2016 PM Peak Irongate with Link Road Stage 1 Development Level of Service	18

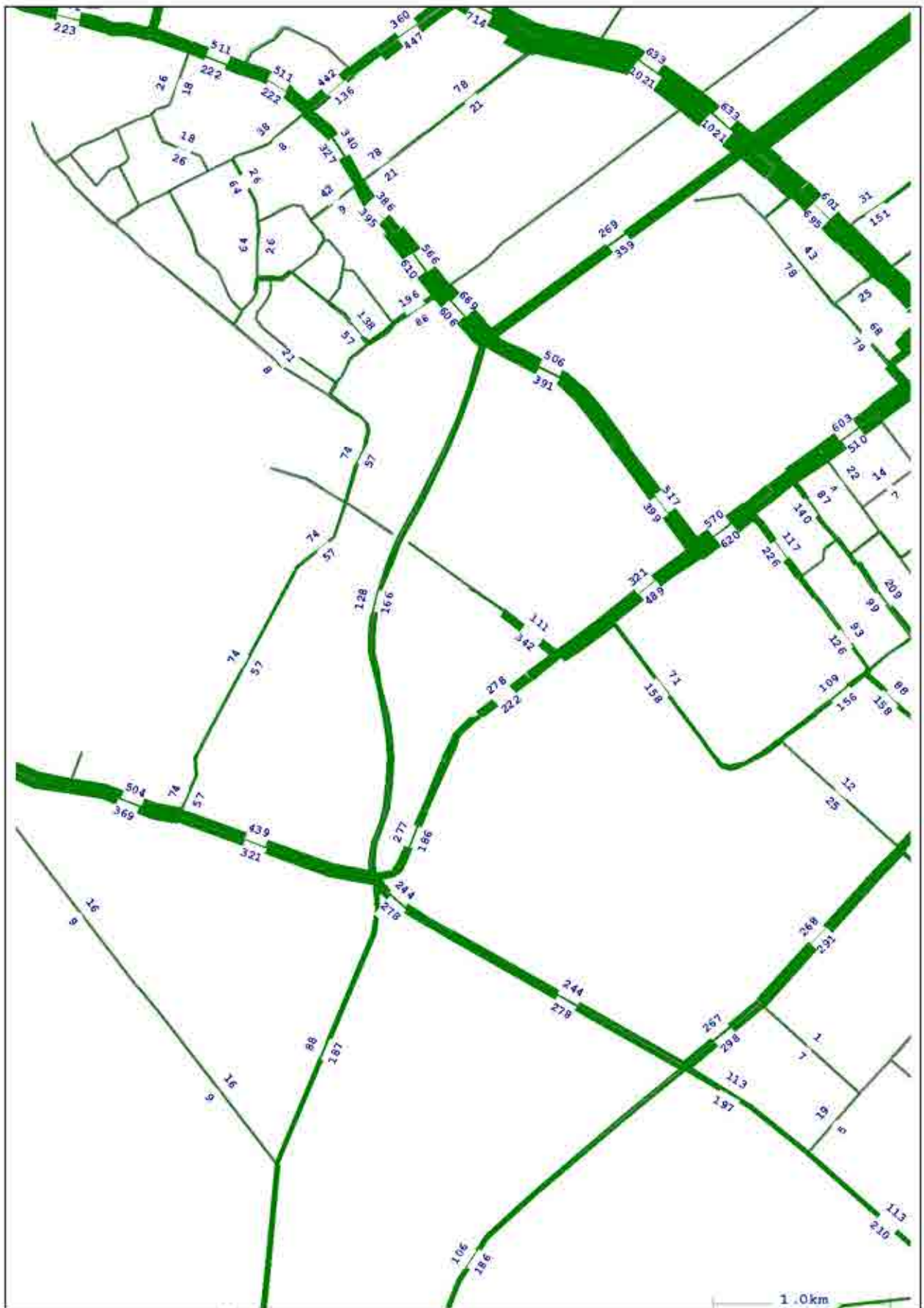

Hawke's Bay Irongate Modelling	2016 AM Peak Irongate Stage 1 Development Traffic Volumes	Figure 1
Gabites Porter Consultants		

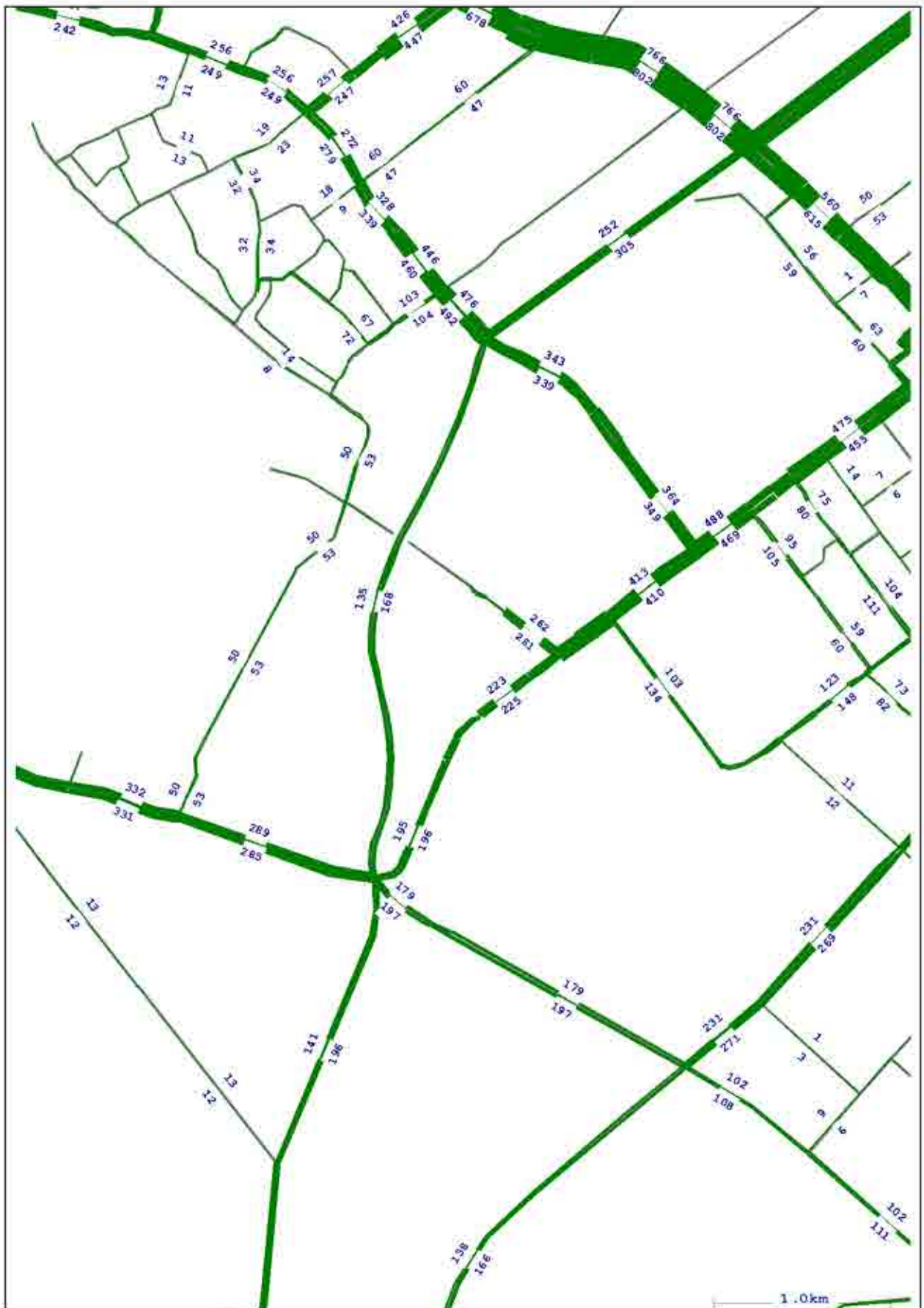

Hawke's Bay Irongate Modelling	2016 SH Peak Irongate Stage 1 Development Traffic Volumes	Figure 2
Gabites Porter Consultants		

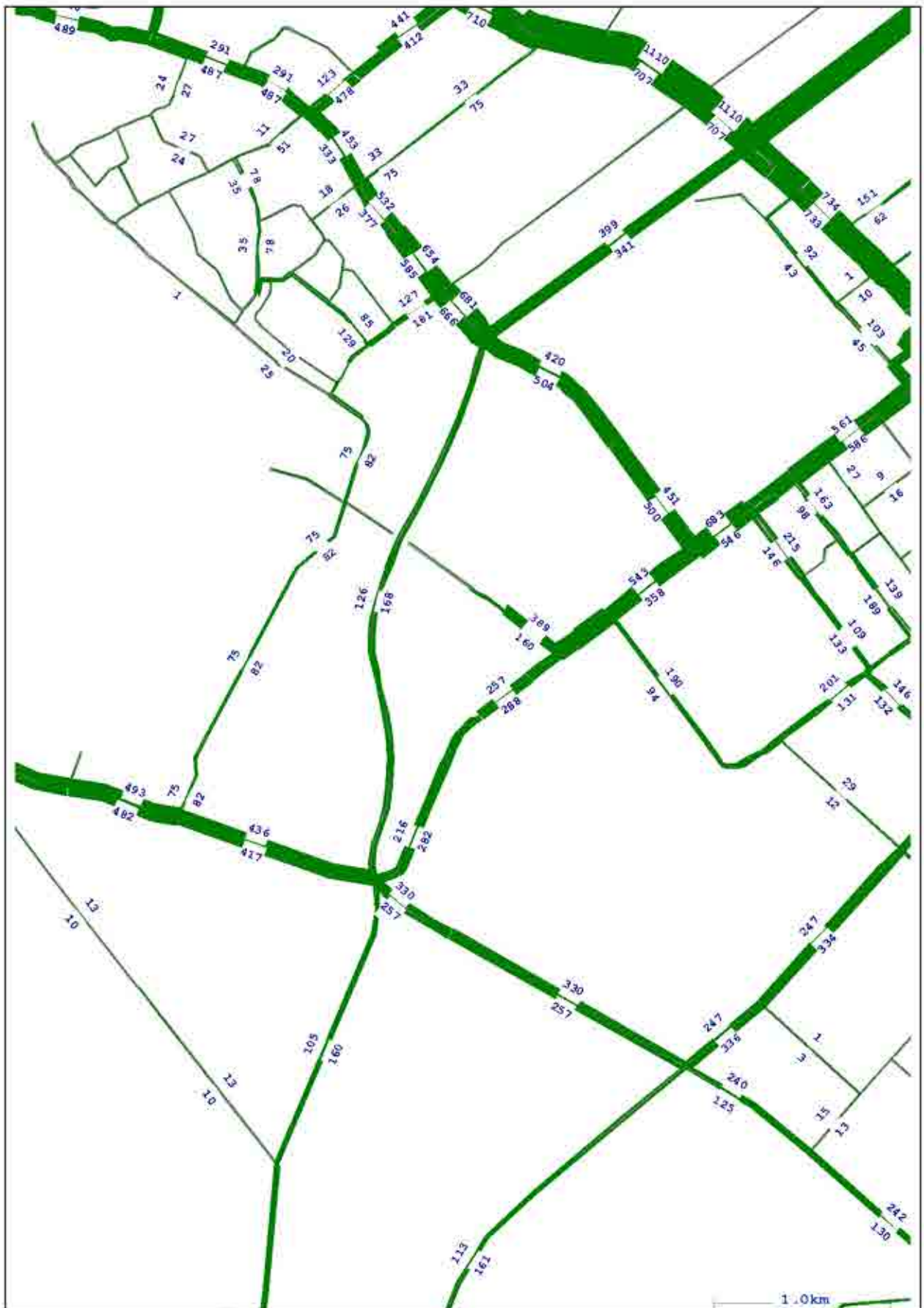

Hawke's Bay Irongate Modelling	2016 PM Peak Irongate Stage 1 Development Traffic Volumes	Figure 3
Gabites Porter Consultants		

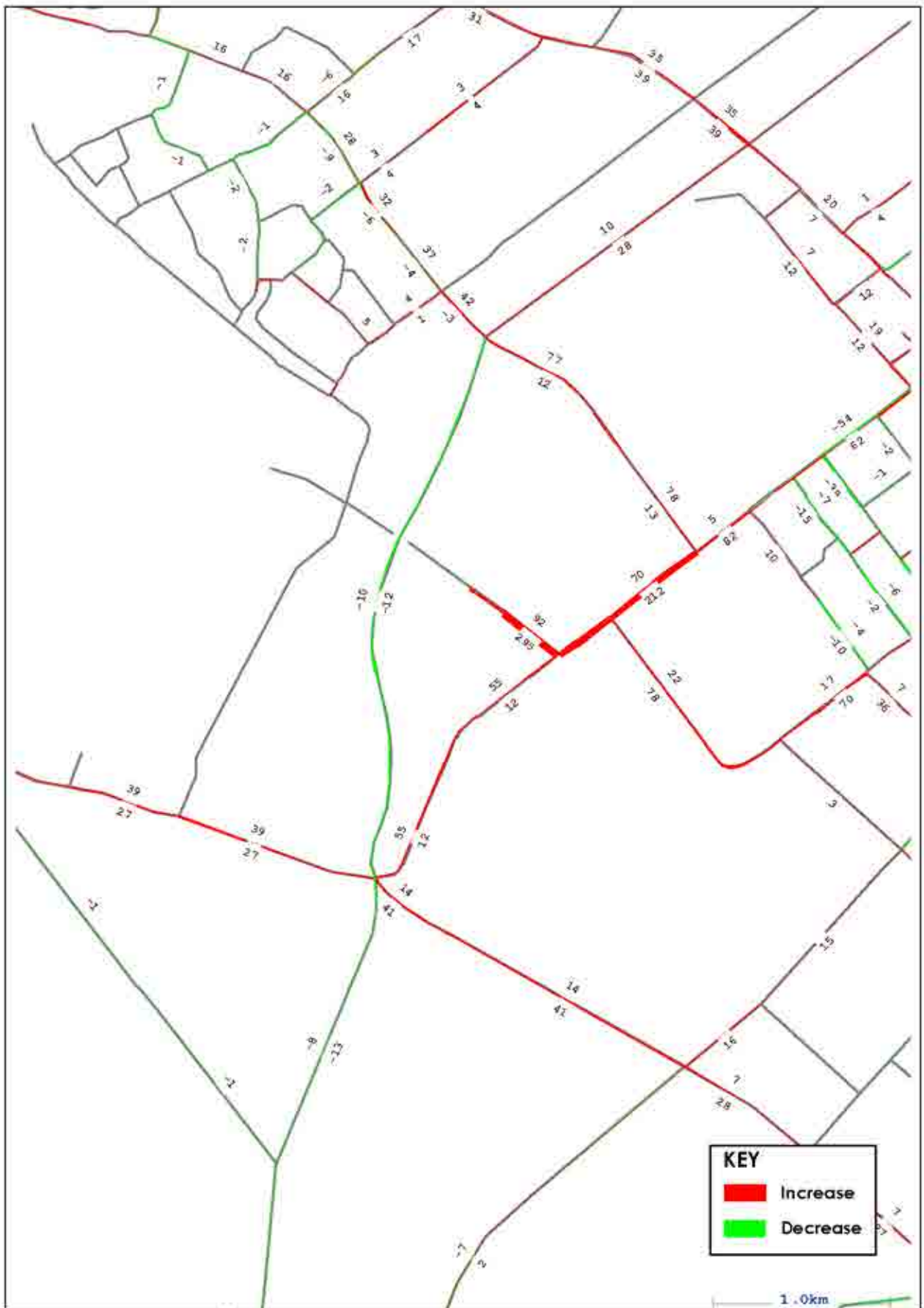

Hawke's Bay Irongate Modelling	2016 AM Peak Irongate Stage 1 Development Change in Traffic Volumes to 2016 Base	Figure 4
Gabites Porter Consultants		

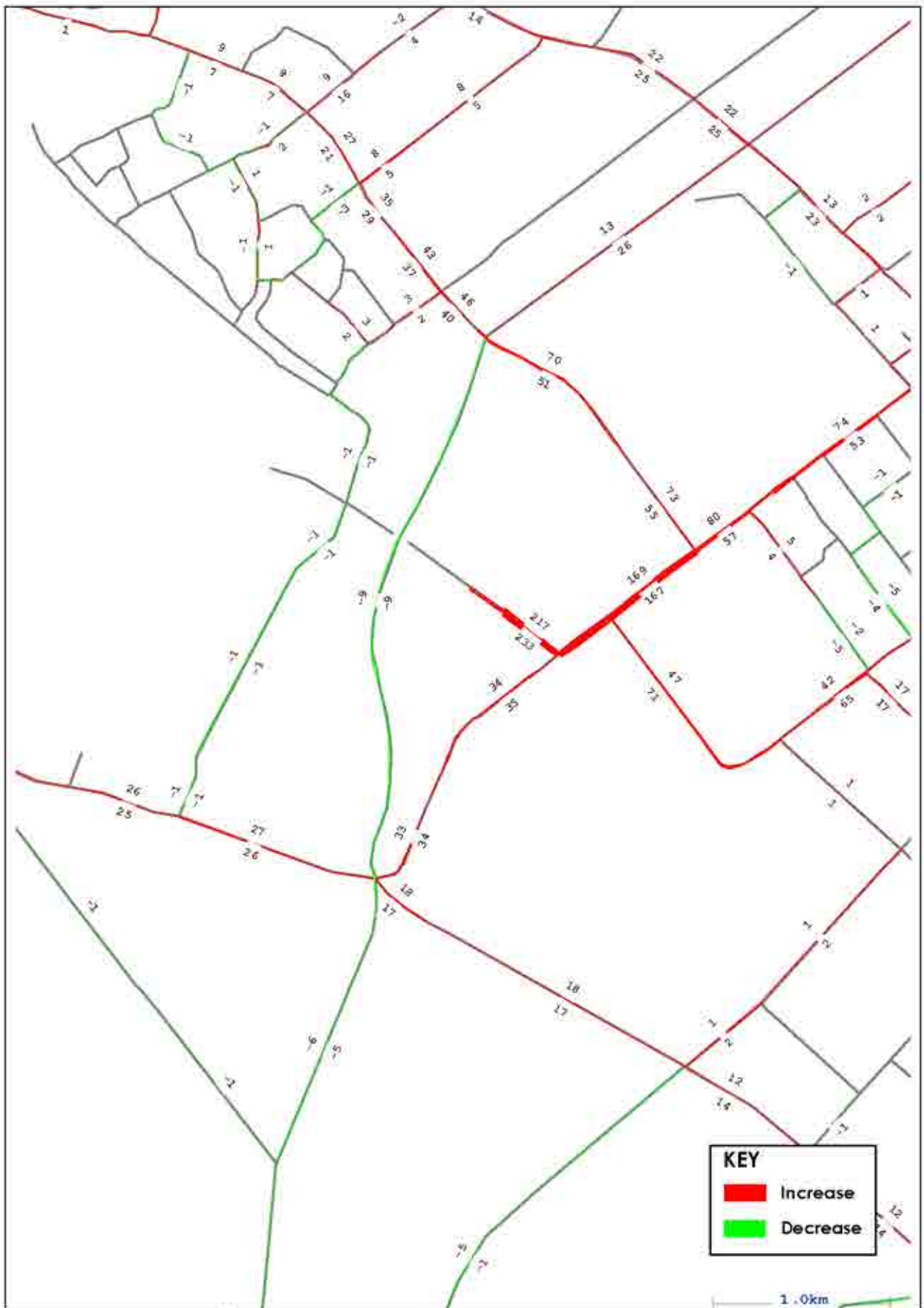

Hawke's Bay Irongate Modelling	2016 SH Peak Irongate Stage 1 Development Change in Traffic Volumes to 2016 Base	Figure 5
Gabites Porter Consultants		

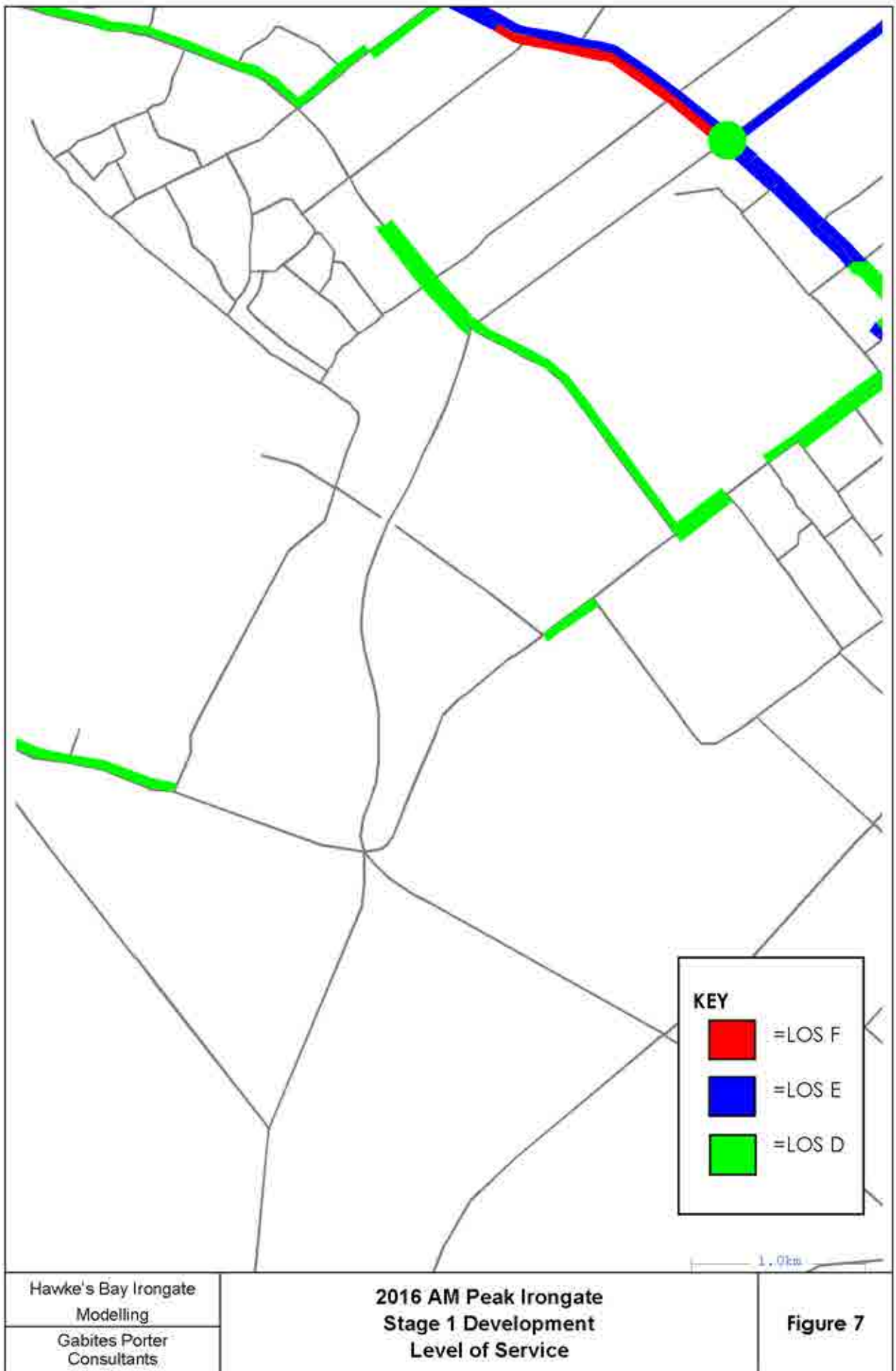

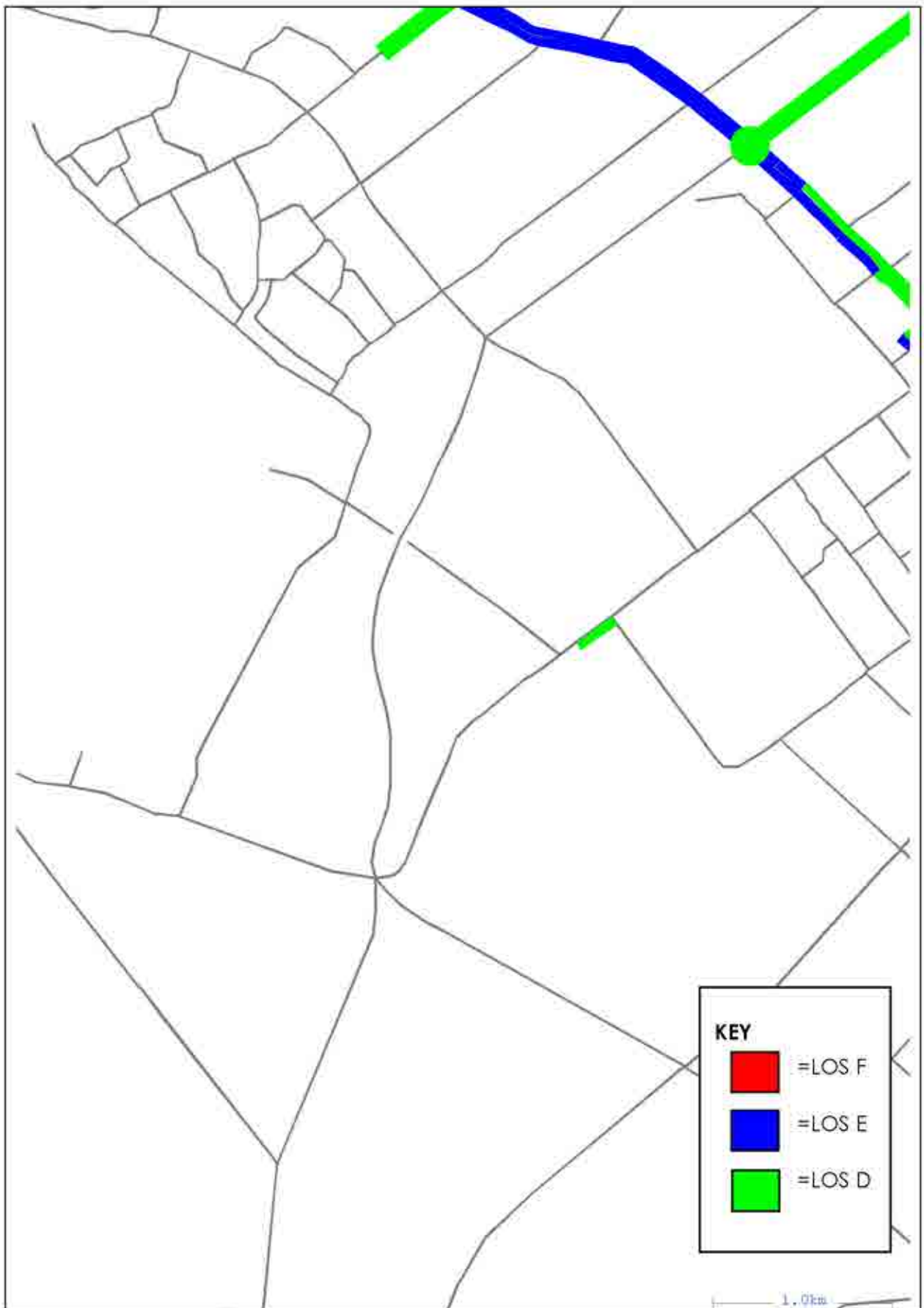

Hawke's Bay Irongate Modelling	2016 SH Peak Irongate Stage 1 Development Level of Service	Figure 8
Gabites Porter Consultants		

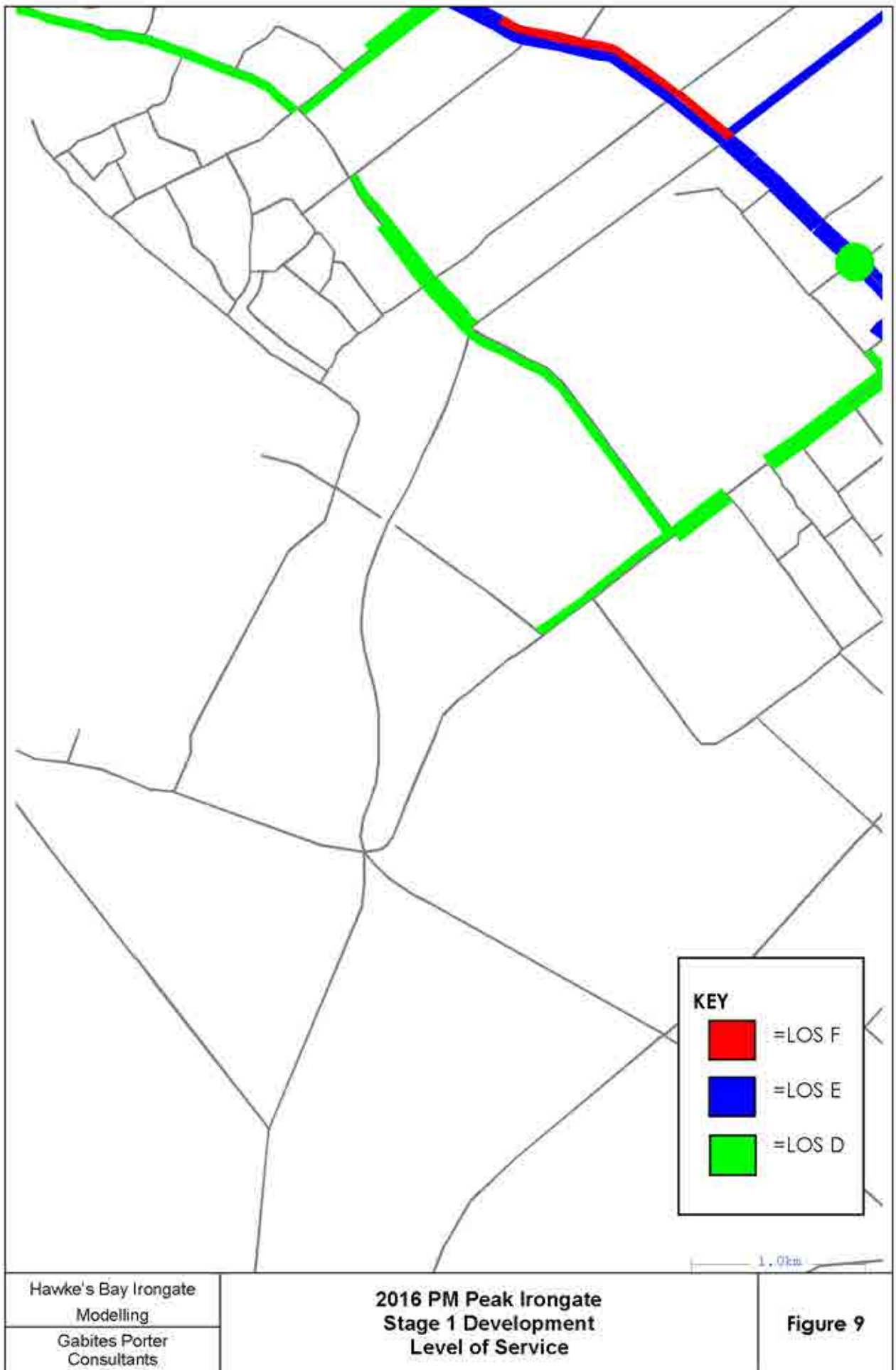

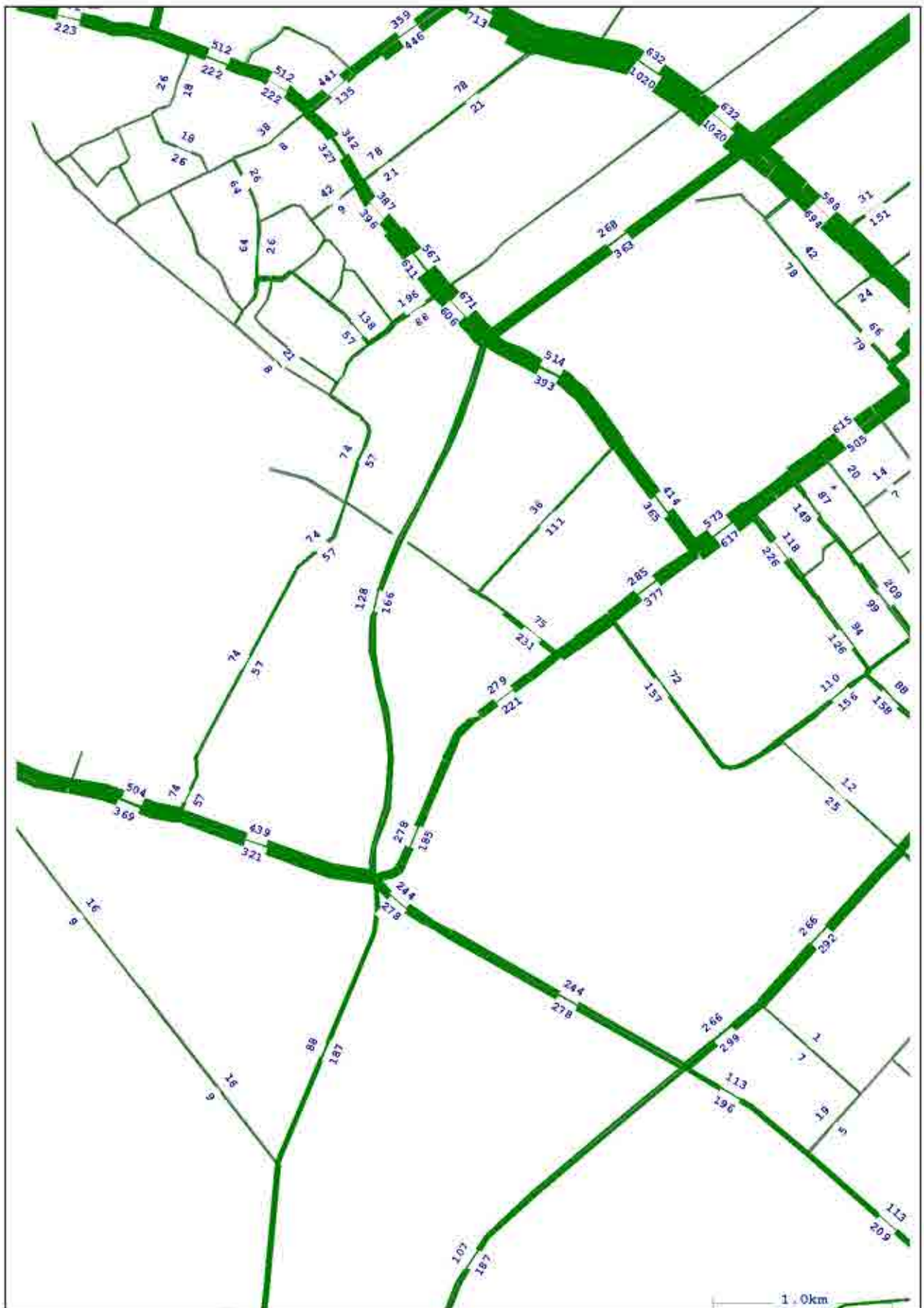

Hawke's Bay Irongate Modelling	2016 AM Peak Irongate with Link Road Stage 1 Development Traffic Volumes	Figure 10
Gabites Porter Consultants		

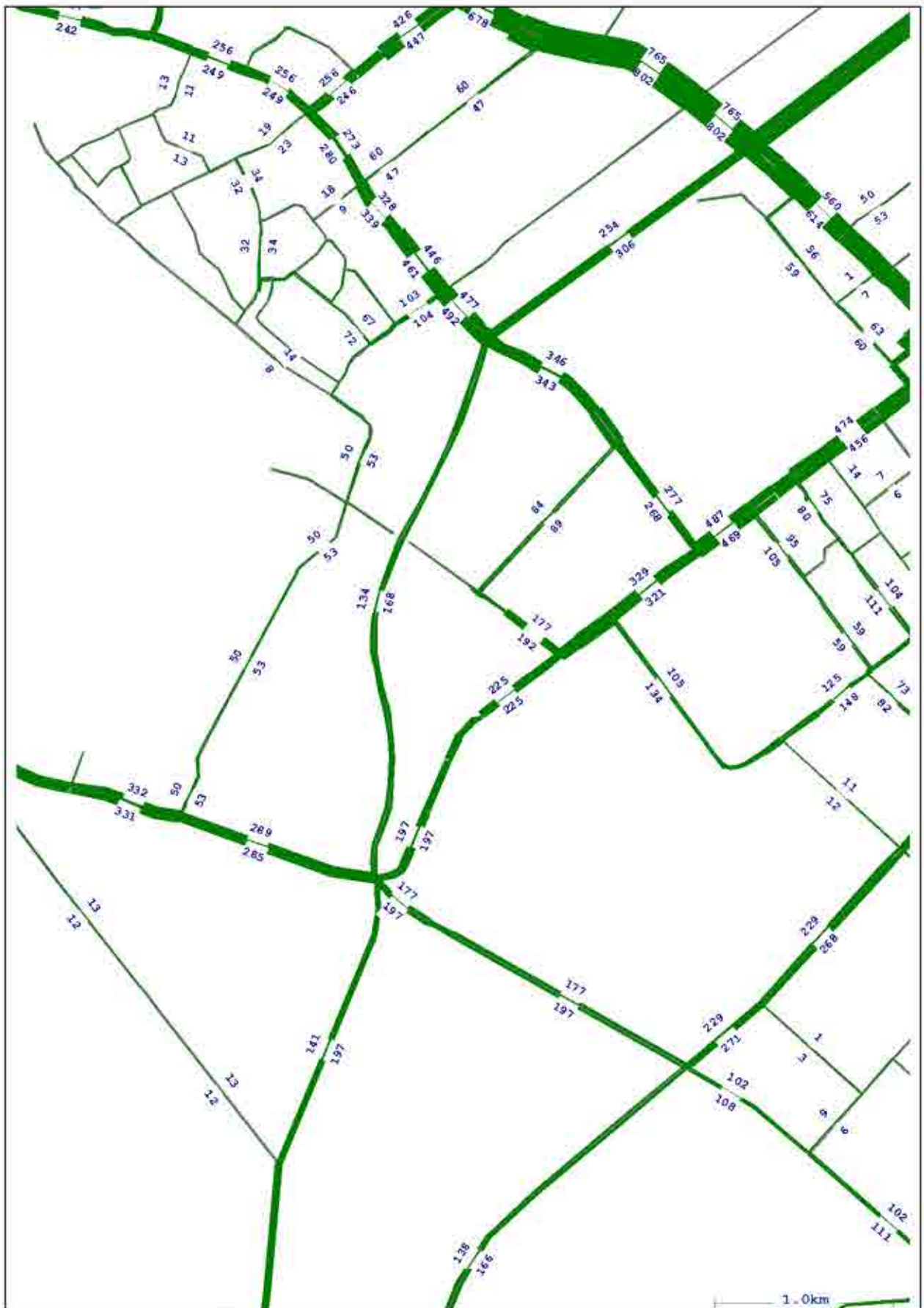

Hawke's Bay Irongate Modelling	2016 SH Peak Irongate with Link Road Stage 1 Development Traffic Volumes	Figure 11
Gabites Porter Consultants		

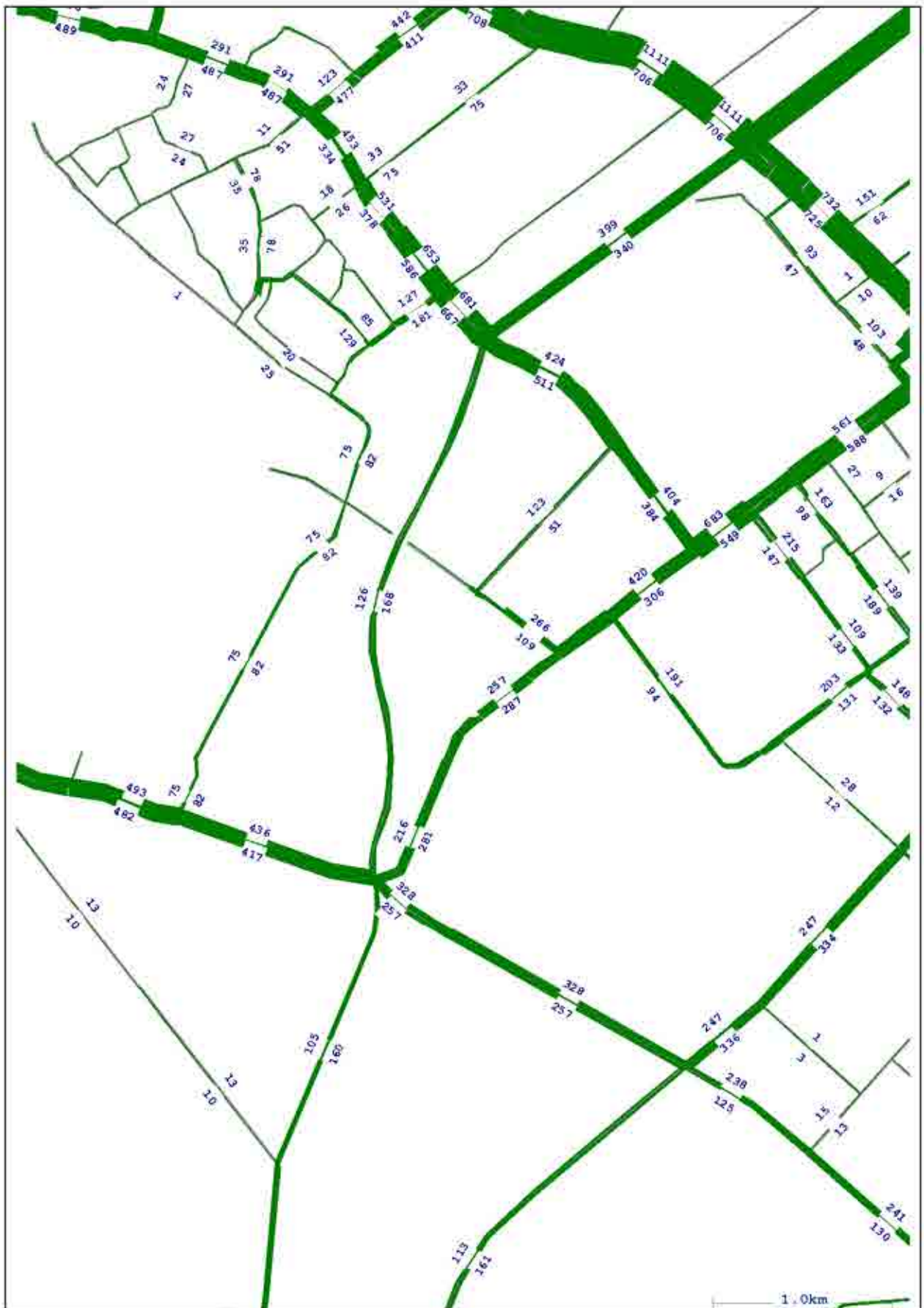

Hawke's Bay Irongate Modelling	2016 PM Peak Irongate with Link Road Stage 1 Development Traffic Volumes	Figure 12
Gabites Porter Consultants		

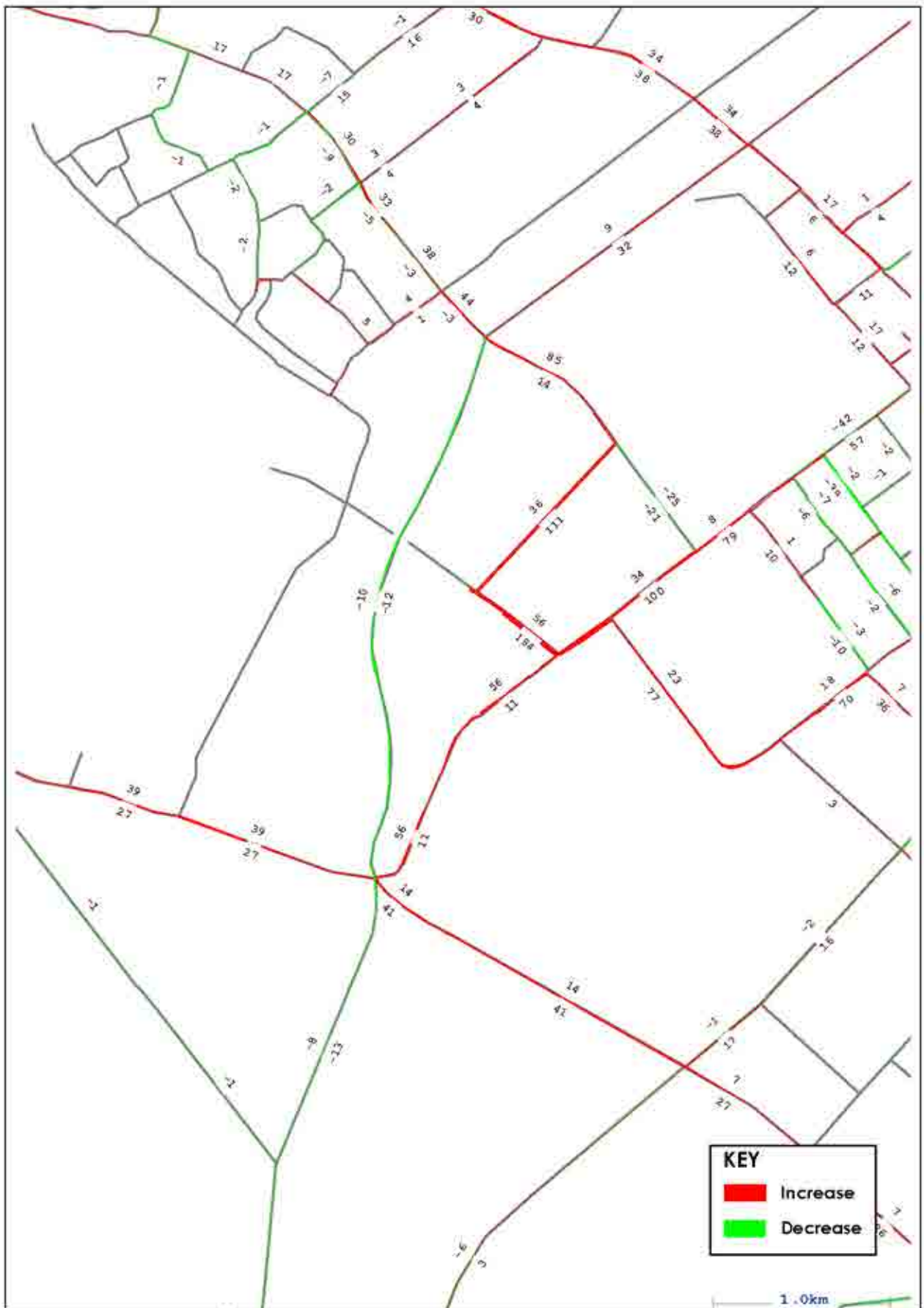

Hawke's Bay Irongate Modelling Gabites Porter Consultants	2016 AM Peak Irongate with Link Road Stage 1 Development Change in Traffic Volumes to 2016 Base	Figure 13
--	--	------------------

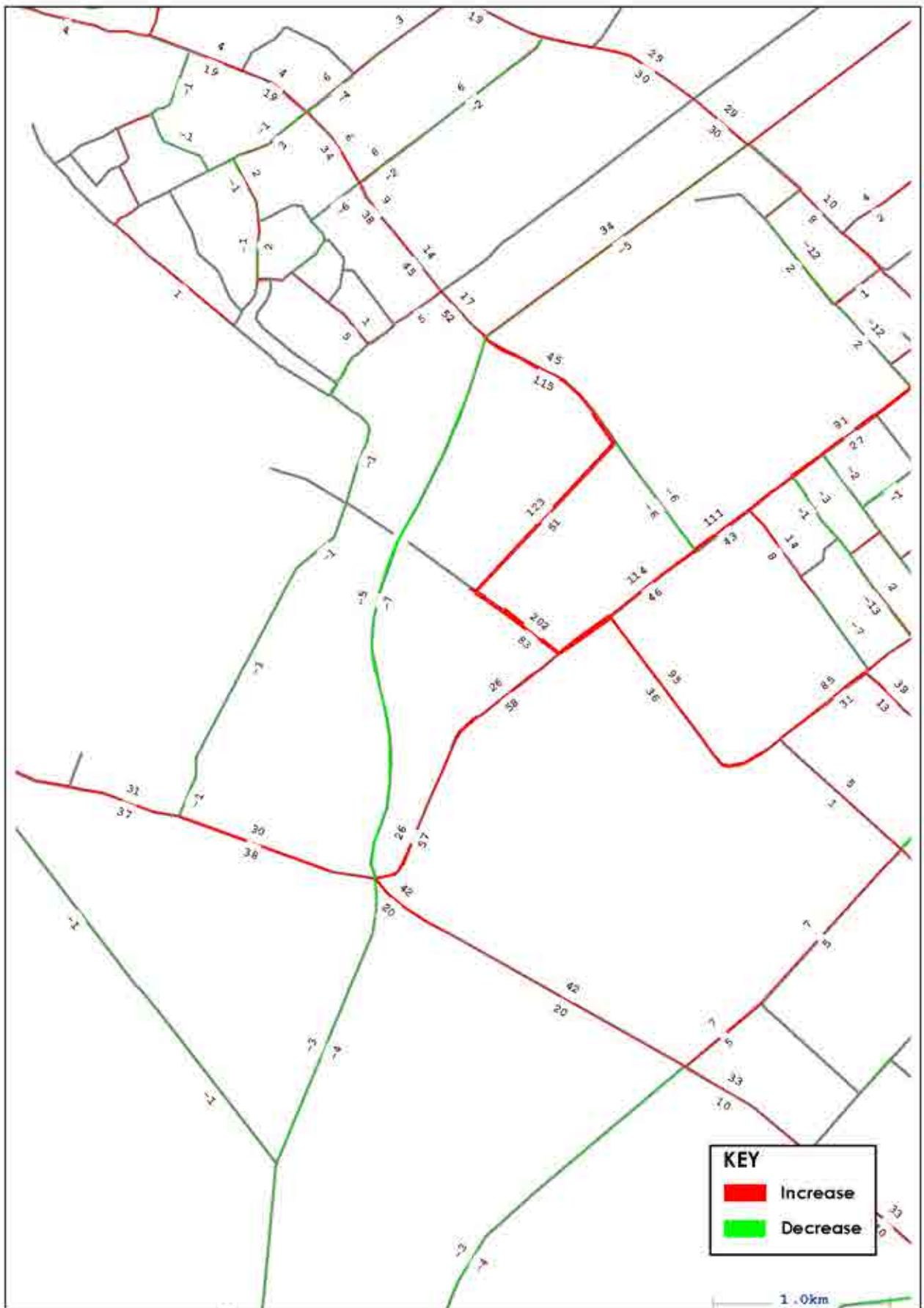

Hawke's Bay Irongate Modelling Gabites Porter Consultants	2016 PM Peak Irongate with Link Road Stage 1 Development Change in Traffic Volumes to 2016 Base	Figure 15
--	--	------------------

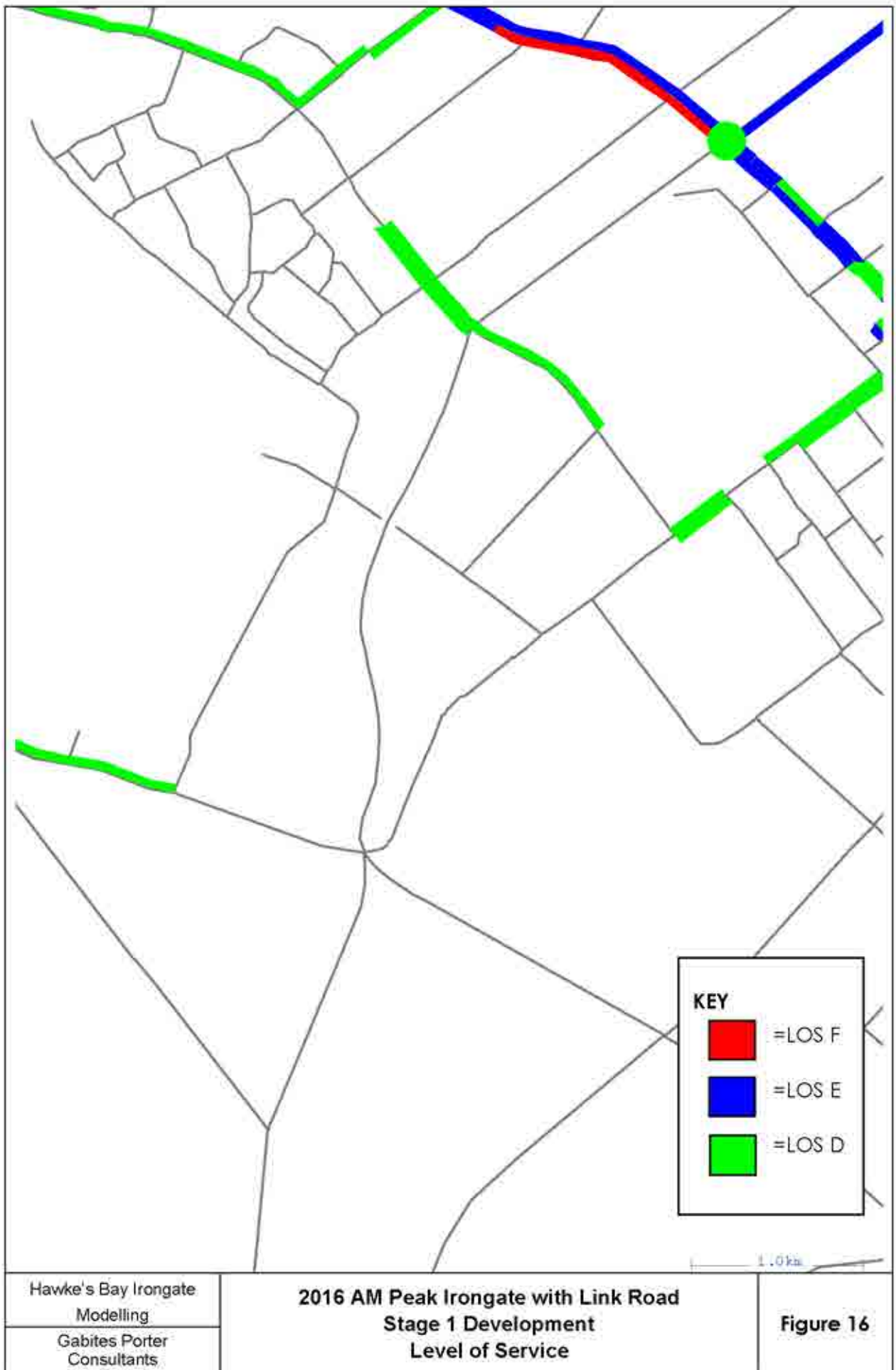

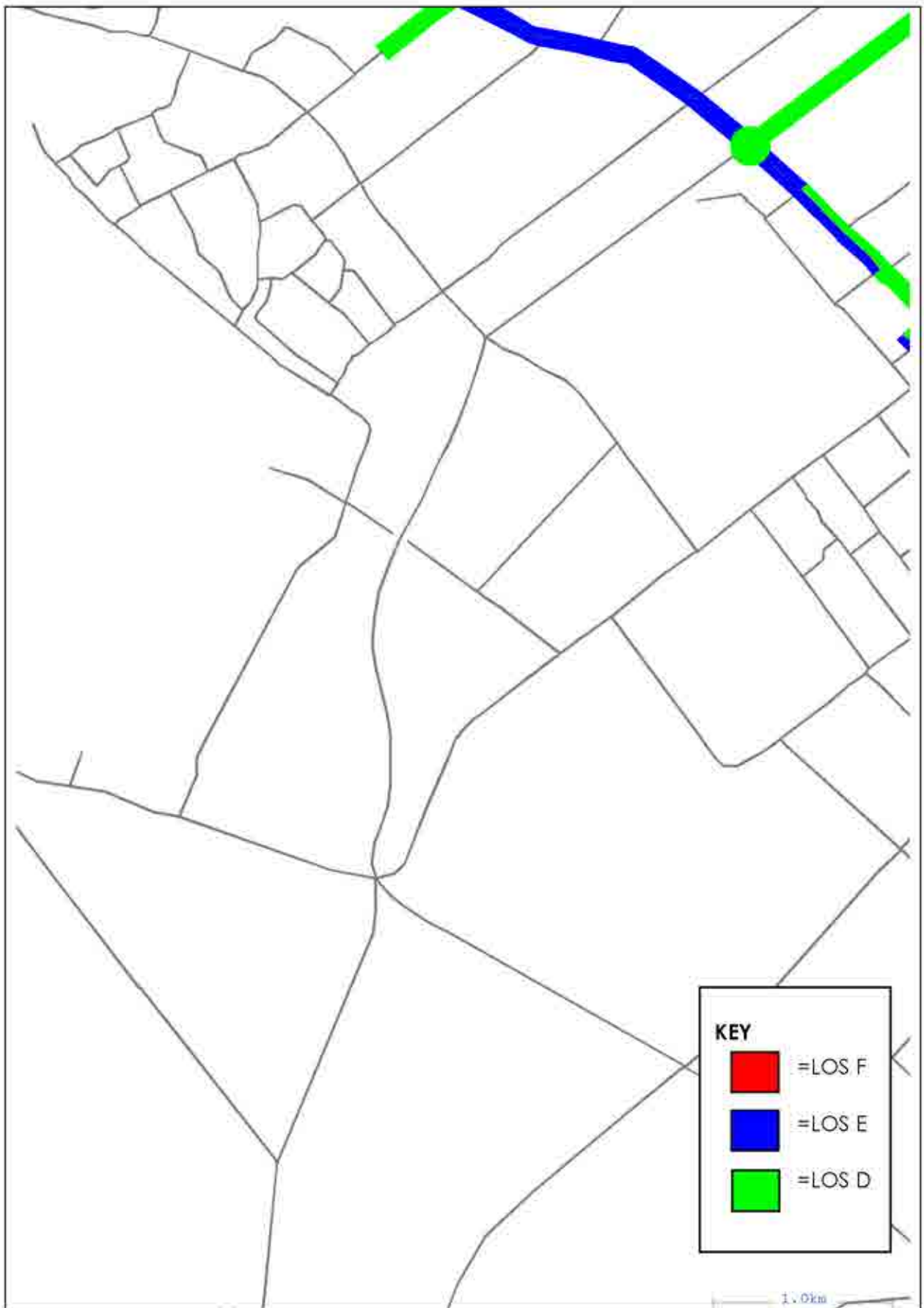

Hawke's Bay Irongate Modelling Gabites Porter Consultants	2016 SH Peak Irongate with Link Road Stage 1 Development Level of Service	Figure 17
--	--	------------------

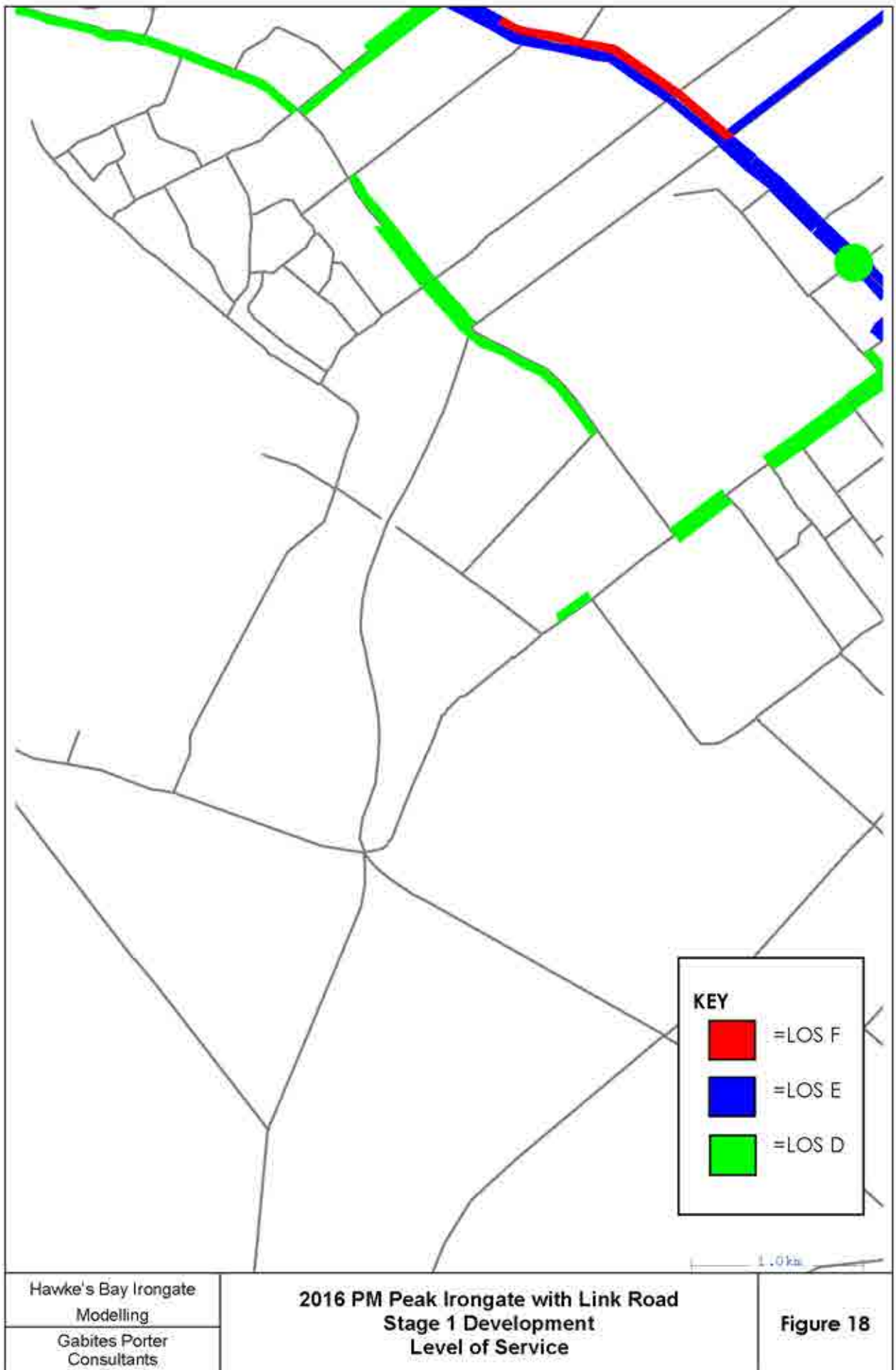

APPENDIX 3

2016 Stage 1+:

- With Irongate development
- With Irongate + York Rd Link with Irongate Rd
- With Irongate + Left turn off expressway into Irongate Rd

1. 2016 AM Peak Irongate Stage 1+ Development Traffic Volumes	1
2. 2016 SH Peak Irongate Stage 1+ Development Traffic Volumes	2
3. 2016 PM Peak Irongate Stage 1+ Development Traffic Volumes	3
4. 2016 AM Peak Irongate Stage 1+ Development Change in Traffic Volumes to 2016 Base	4
5. 2016 SH Peak Irongate Stage 1+ Development Change in Traffic Volumes to 2016 Base	5
6. 2016 PM Peak Irongate Stage 1+ Development Change in Traffic Volumes to 2016 Base	6
7. 2016 AM Peak Irongate Stage 1+ Development Level of Service	7
8. 2016 SH Peak Irongate Stage 1+ Development Level of Service	8
9. 2016 PM Peak Irongate Stage 1+ Development Level of Service	9
10. 2016 AM Peak Irongate with Link Road Stage 1+ Development Traffic Volumes	10
11. 2016 SH Peak Irongate with Link Road Stage 1+ Development Traffic Volumes	11
12. 2016 PM Peak Irongate with Link Road Stage 1+ Development Traffic Volumes	12
13. 2016 AM Peak Irongate with Link Road Stage 1+ Development Change in Traffic Volumes to 2016 Base	13
14. 2016 SH Peak Irongate with Link Road Stage 1+ Development Change in Traffic Volumes to 2016 Base	14
15. 2016 PM Peak Irongate with Link Road Stage 1+ Development Change in Traffic Volumes to 2016 Base	15
16. 2016 AM Peak Irongate with Link Road Stage 1+ Development Level of Service	16
17. 2016 SH Peak Irongate with Link Road Stage 1+ Development Level of Service	17
18. 2016 PM Peak Irongate with Link Road Stage 1+ Development Level of Service	18

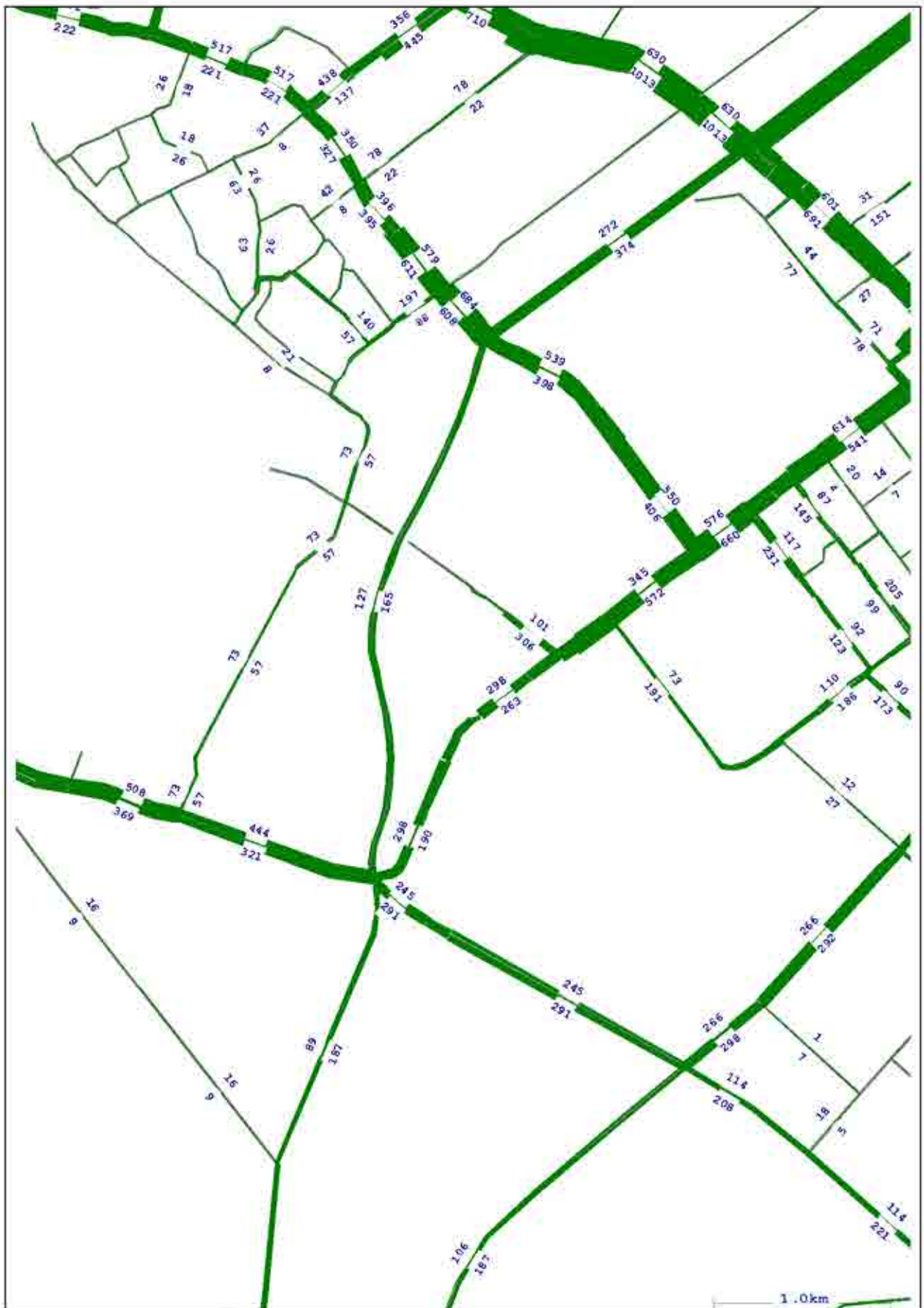

Hawke's Bay Irongate Modelling	2016 AM Peak Irongate Stage 1+ Development Traffic Volumes	Figure 1
Gabites Porter Consultants		

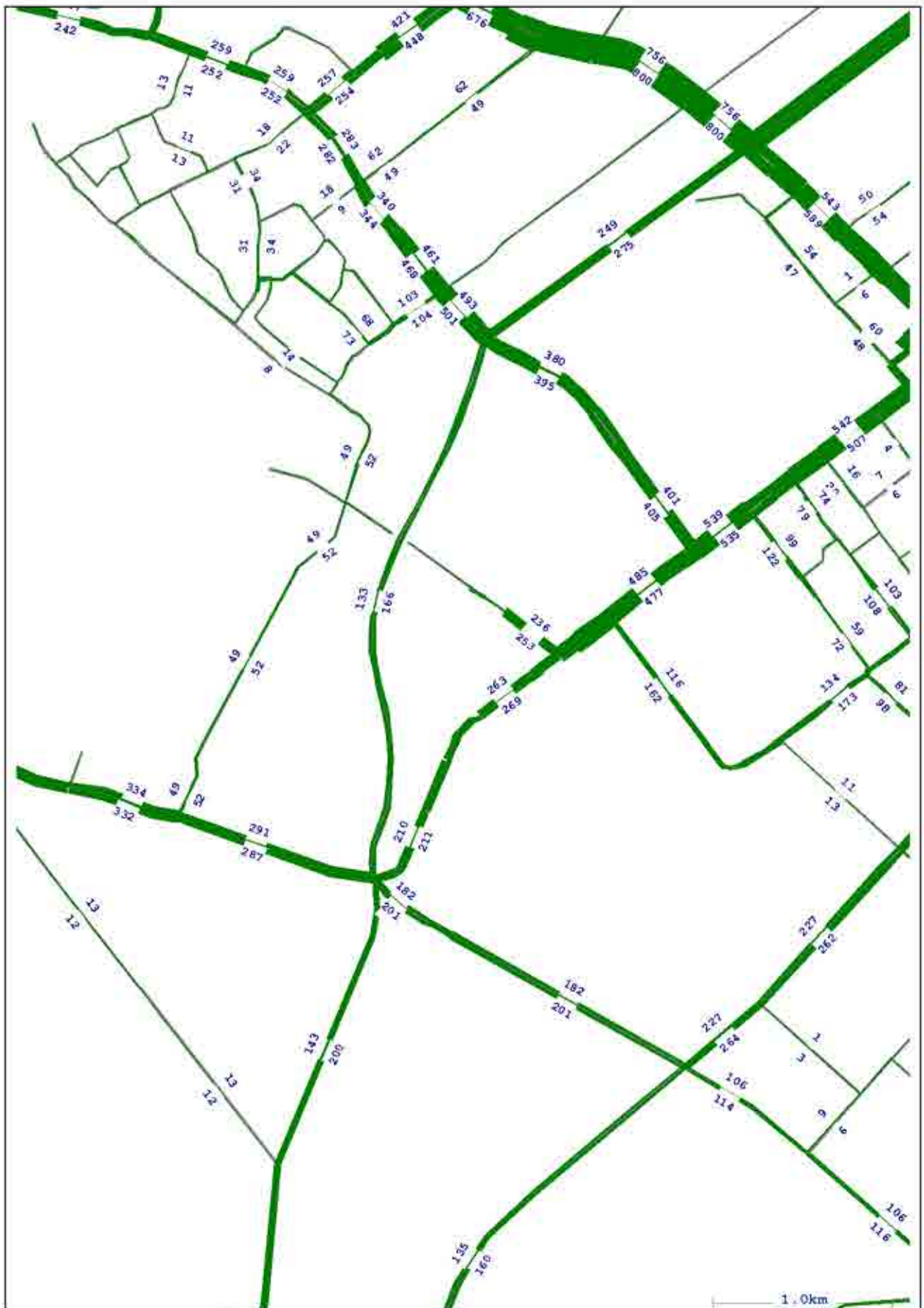

Hawke's Bay Irongate Modelling	2016 SH Peak Irongate Stage 1+ Development Traffic Volumes	Figure 2
Gabites Porter Consultants		

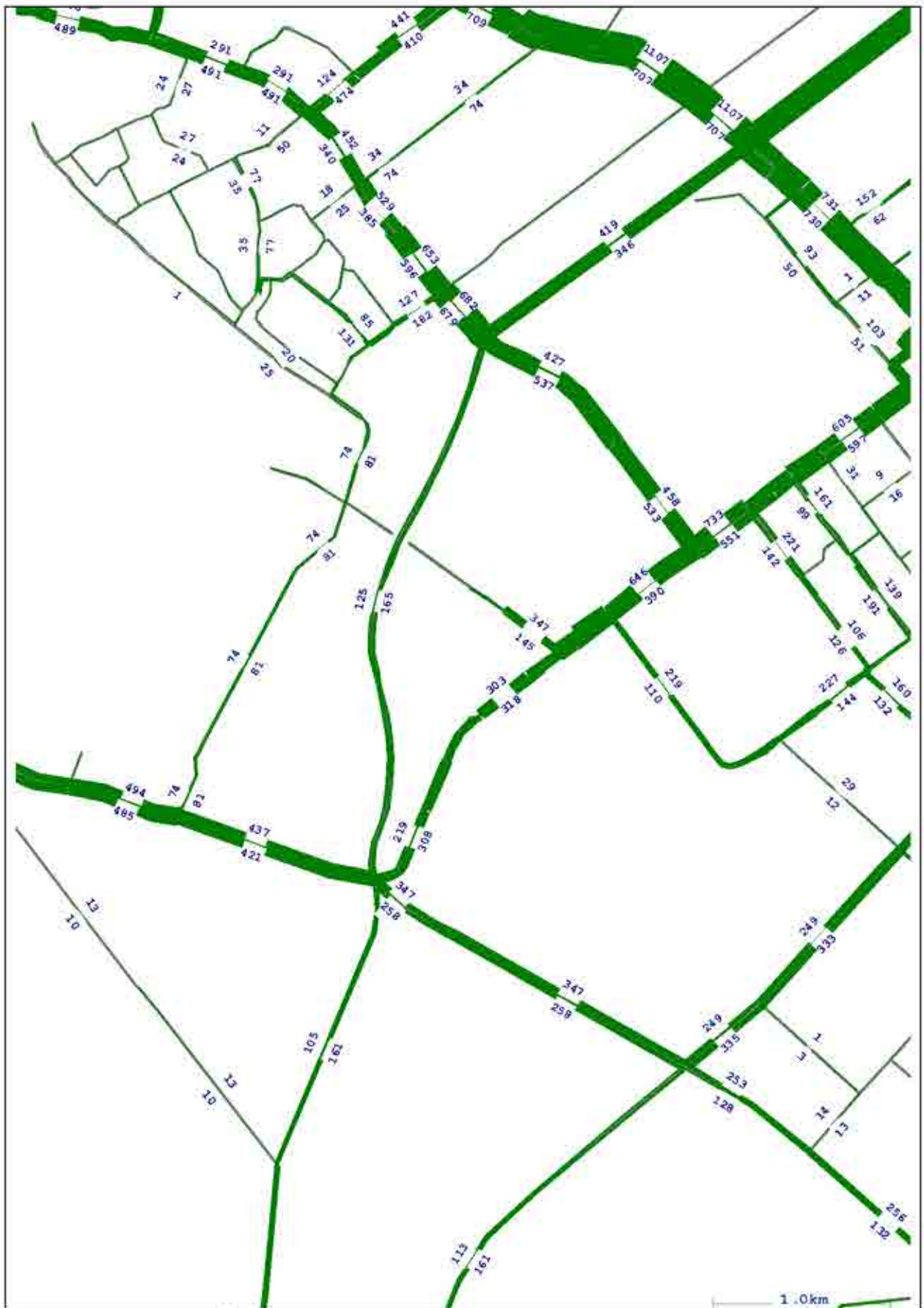

Hawke's Bay Irongate Modelling	2016 PM Peak Irongate Stage 1+ Development Traffic Volumes	Figure 3
Gabites Porter Consultants		

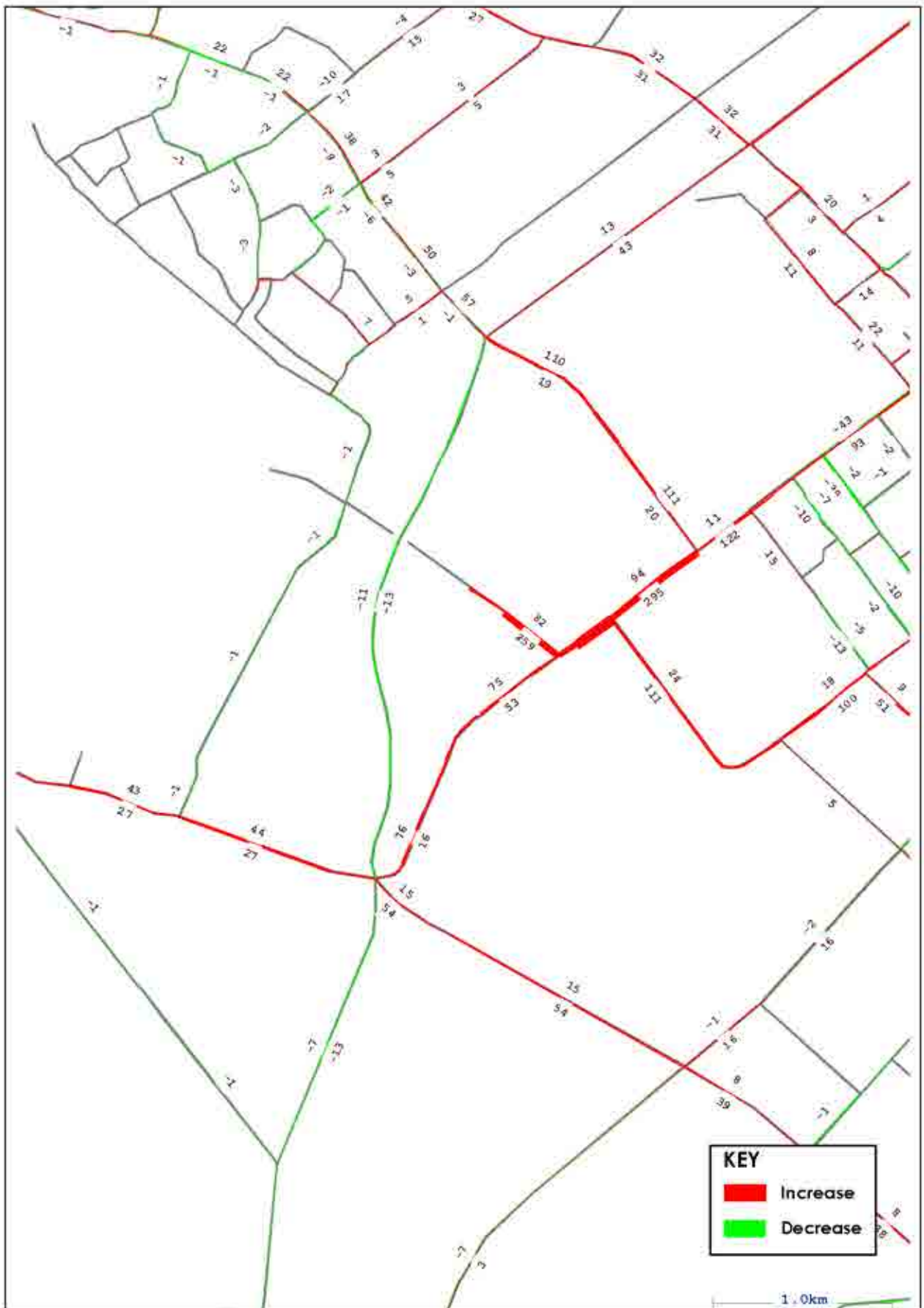

Hawke's Bay Irongate Modelling	2016 AM Peak Irongate Stage 1+ Development Change in Traffic Volumes to 2016 Base	Figure 4
Gabites Porter Consultants		

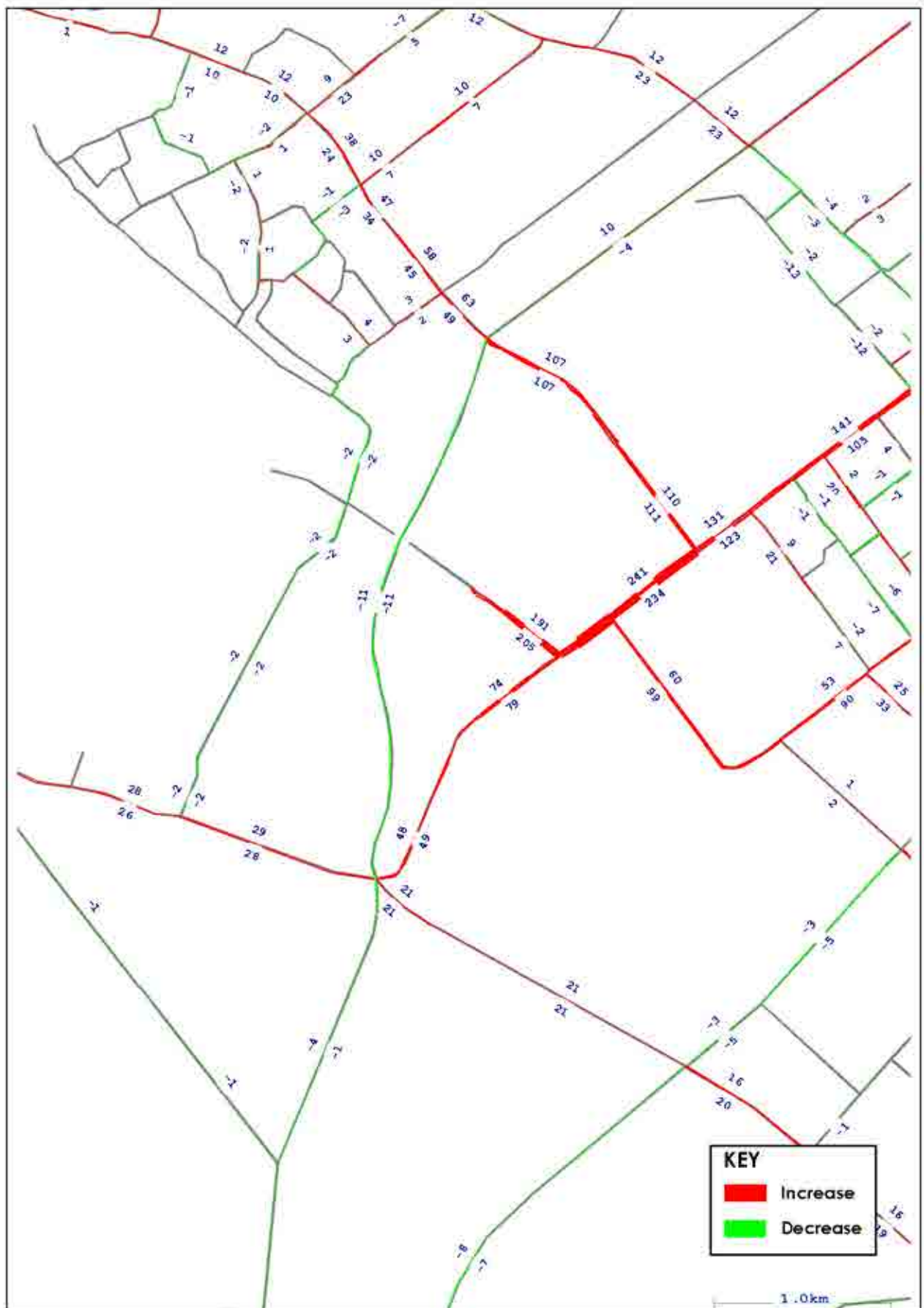

Hawke's Bay Irongate Modelling Gabites Porter Consultants	2016 SH Peak Irongate Stage 1+ Development Change in Traffic Volumes to 2016 Base	Figure 5
--	--	-----------------

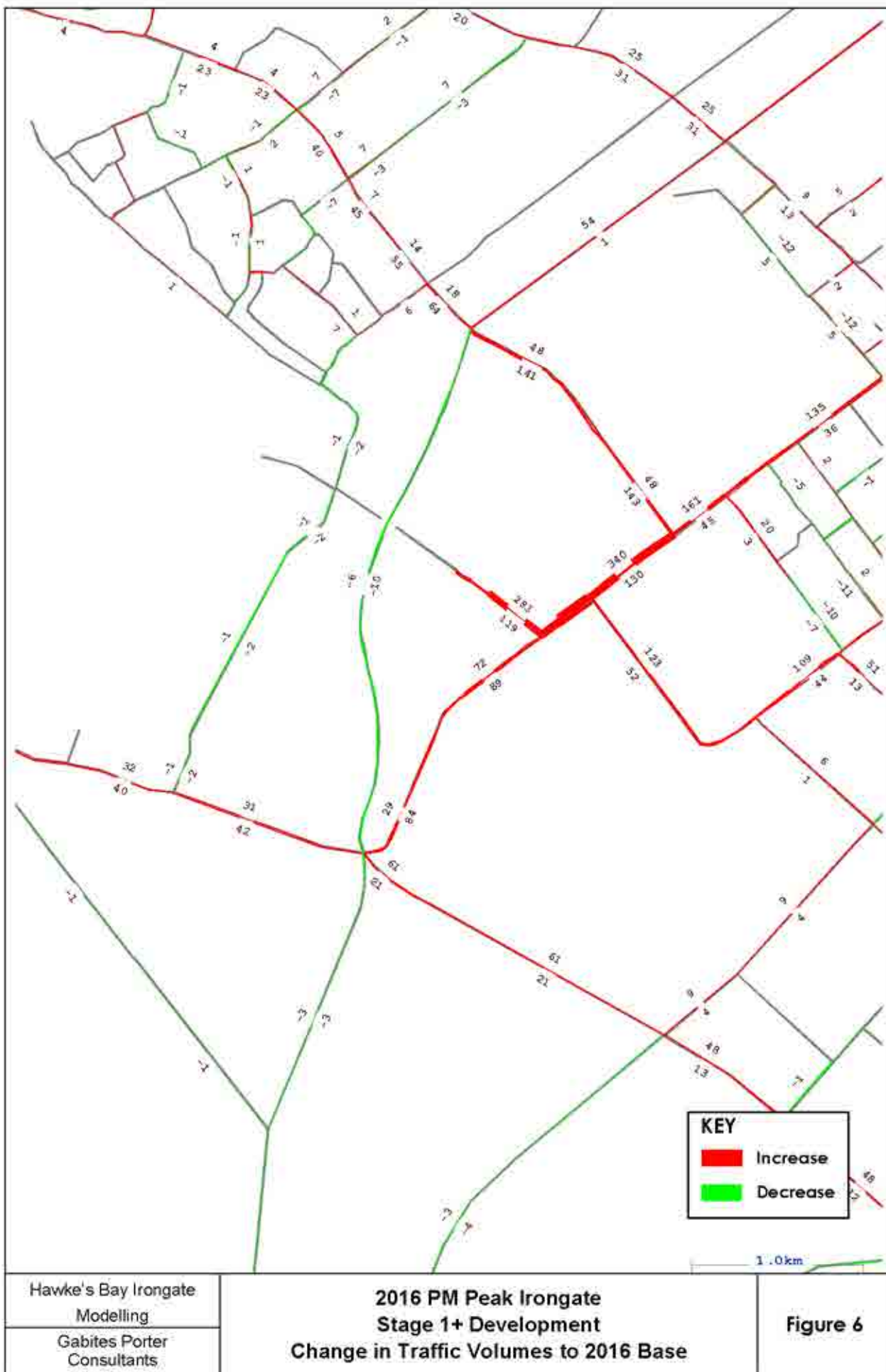

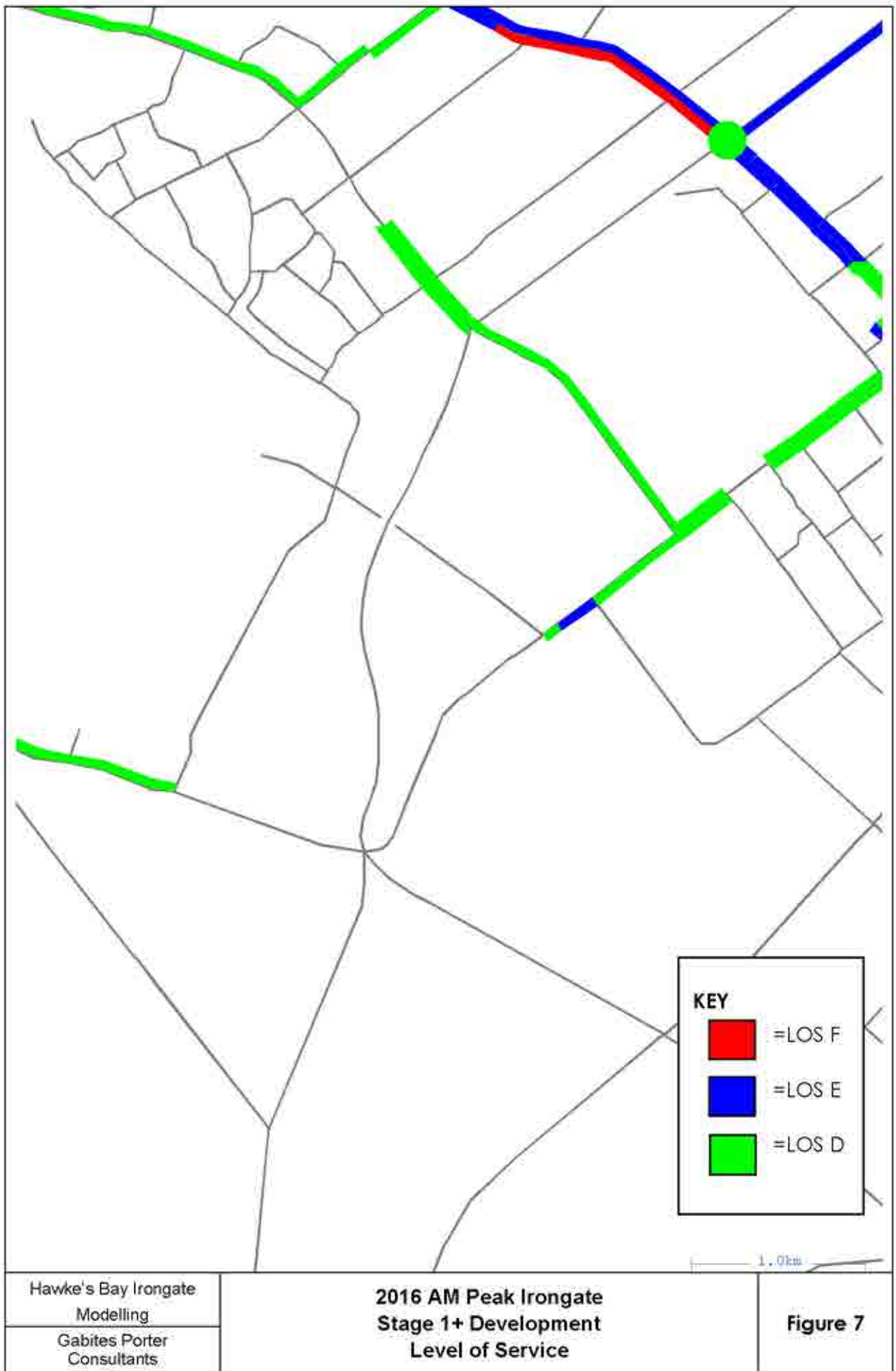



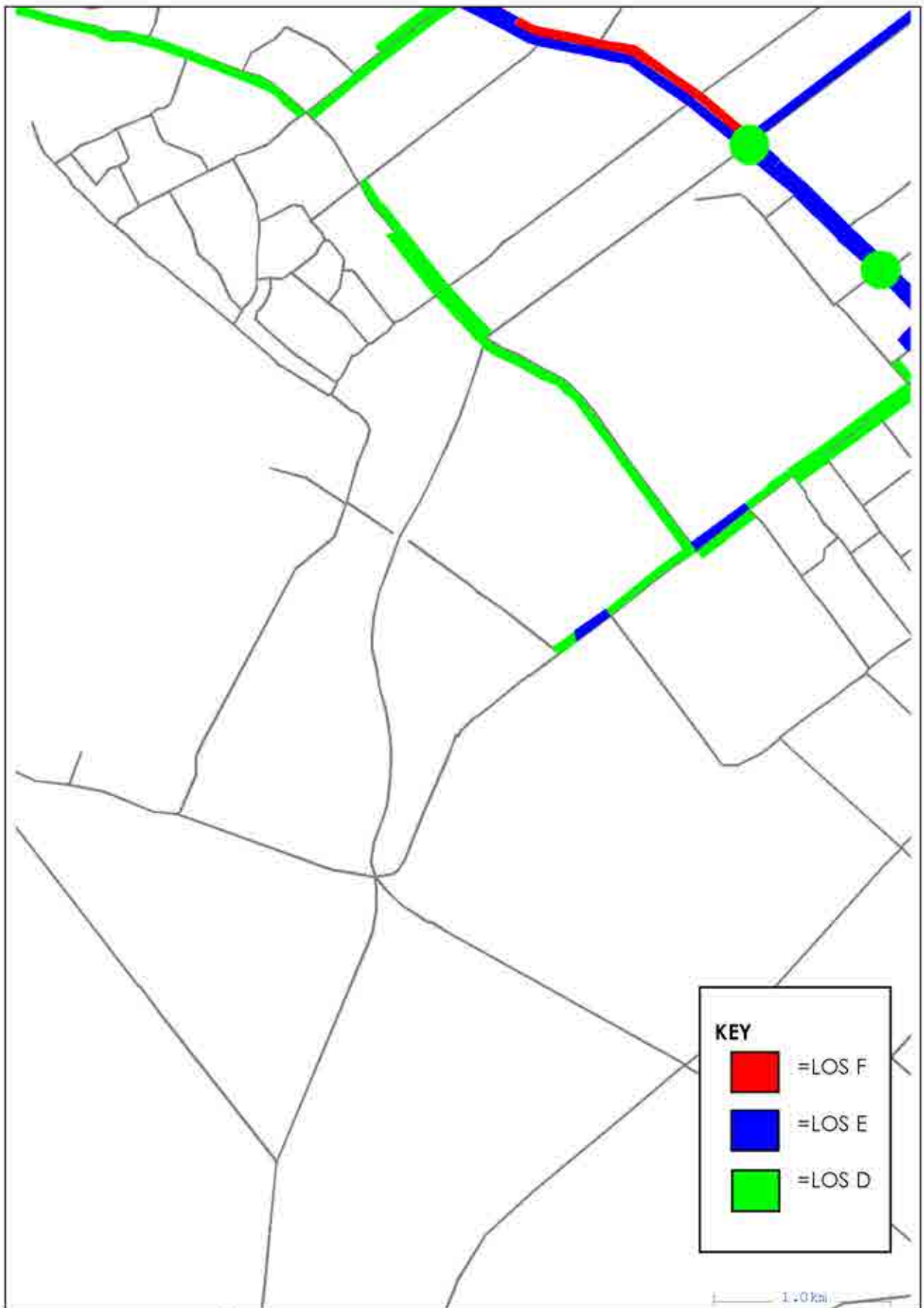

Hawke's Bay Irongate
Modelling
Gabites Porter
Consultants

**2016 PM Peak Irongate
Stage 1+ Development
Level of Service**

Figure 9

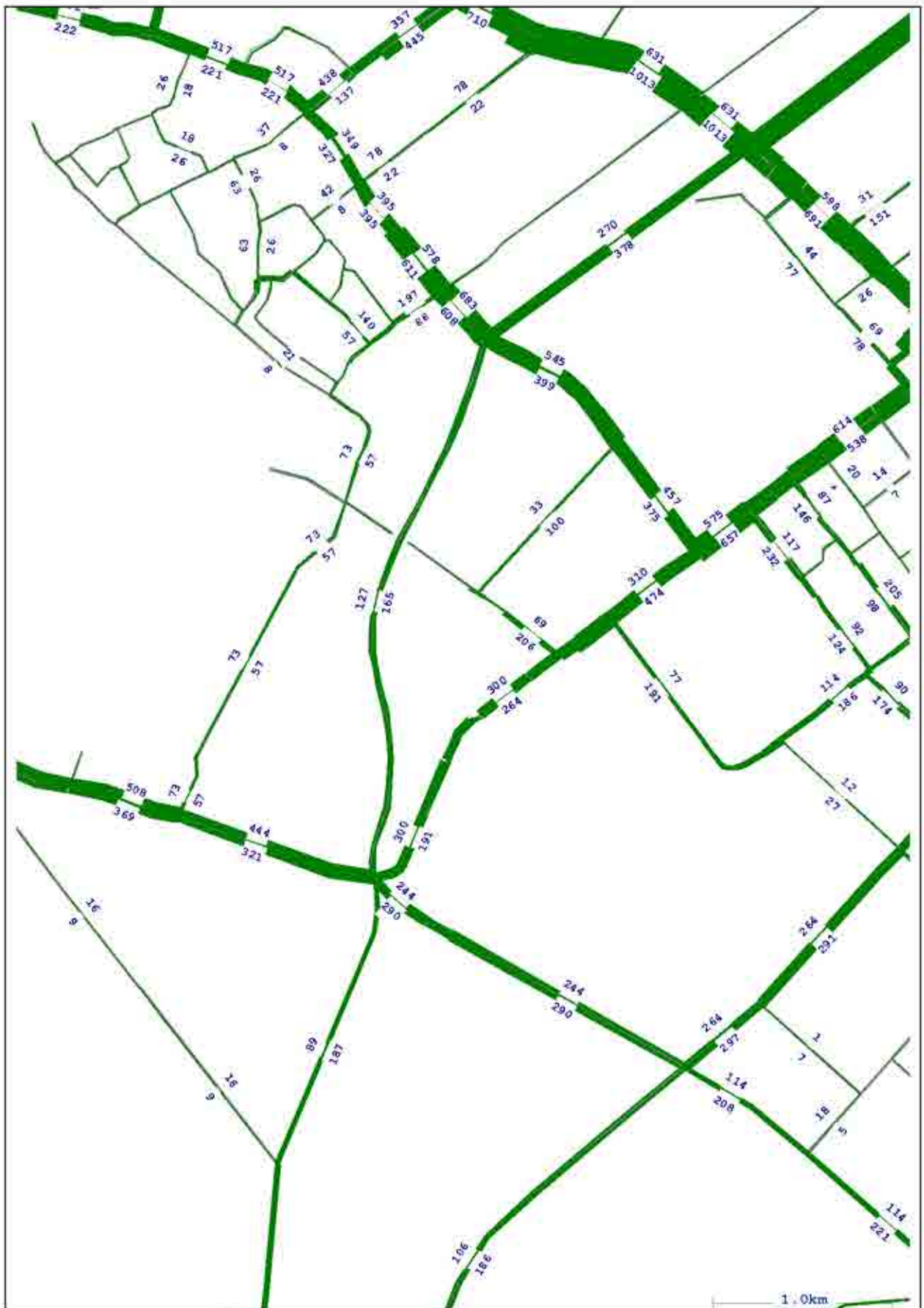

Hawke's Bay Irongate Modelling	2016 AM Peak Irongate with Link Road Stage 1+ Development Traffic Volumes	Figure 10
Gabites Porter Consultants		

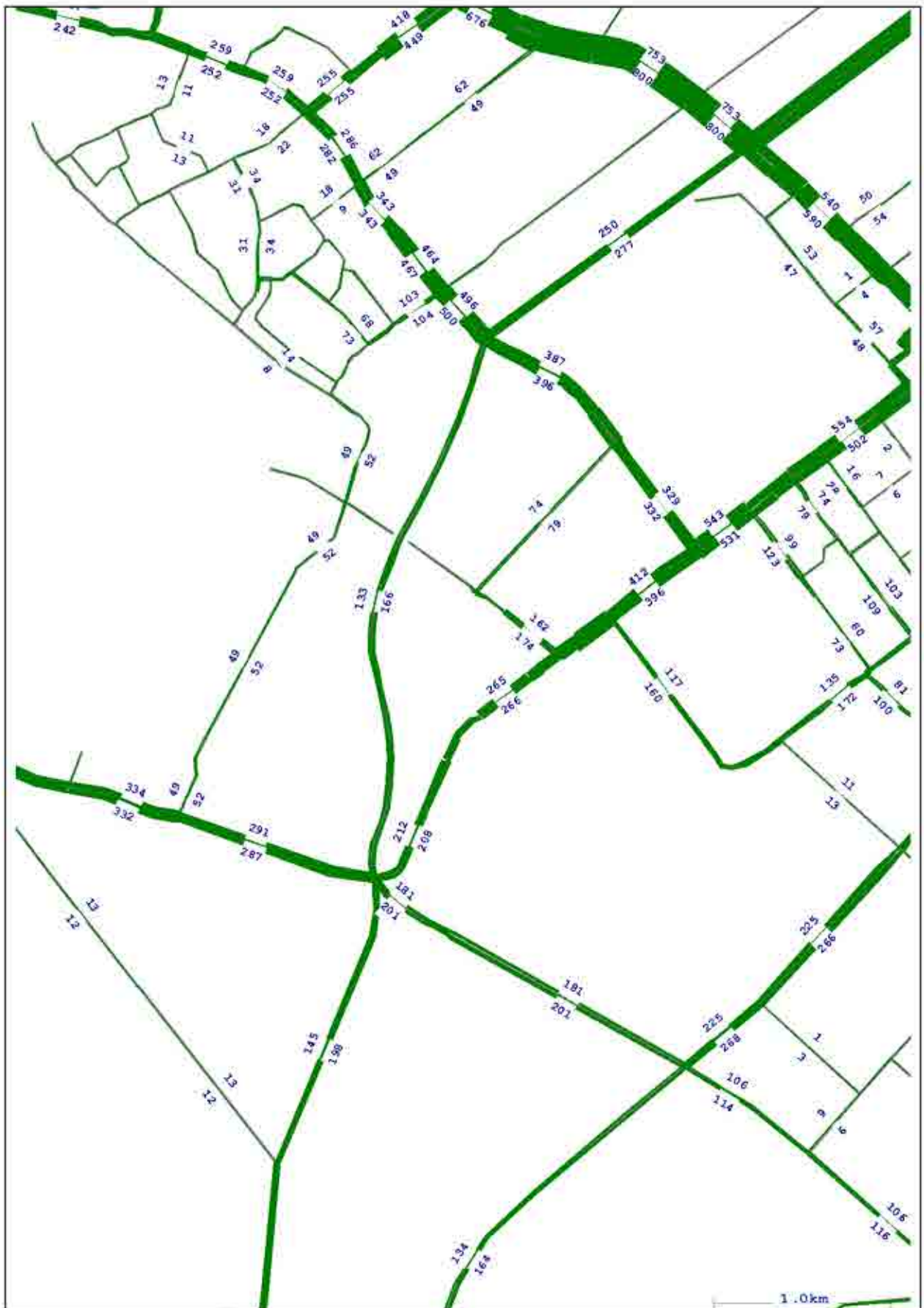

Hawke's Bay Irongate Modelling	2016 SH Peak Irongate with Link Road Stage 1+ Development Traffic Volumes	Figure 11
Gabites Porter Consultants		

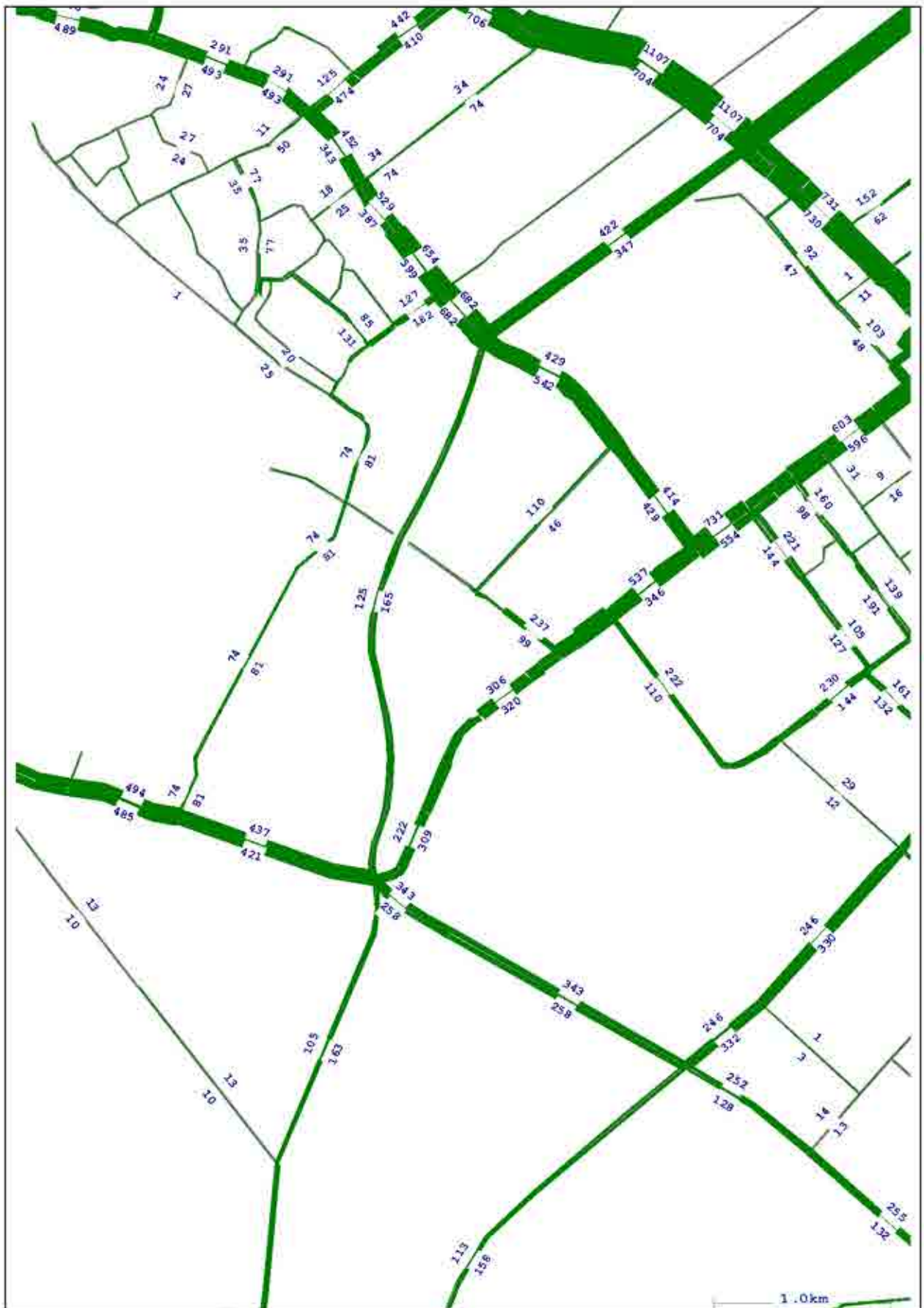

Hawke's Bay Irongate Modelling	2016 PM Peak Irongate with Link Road Stage 1+ Development Traffic Volumes	Figure 12
Gabites Porter Consultants		

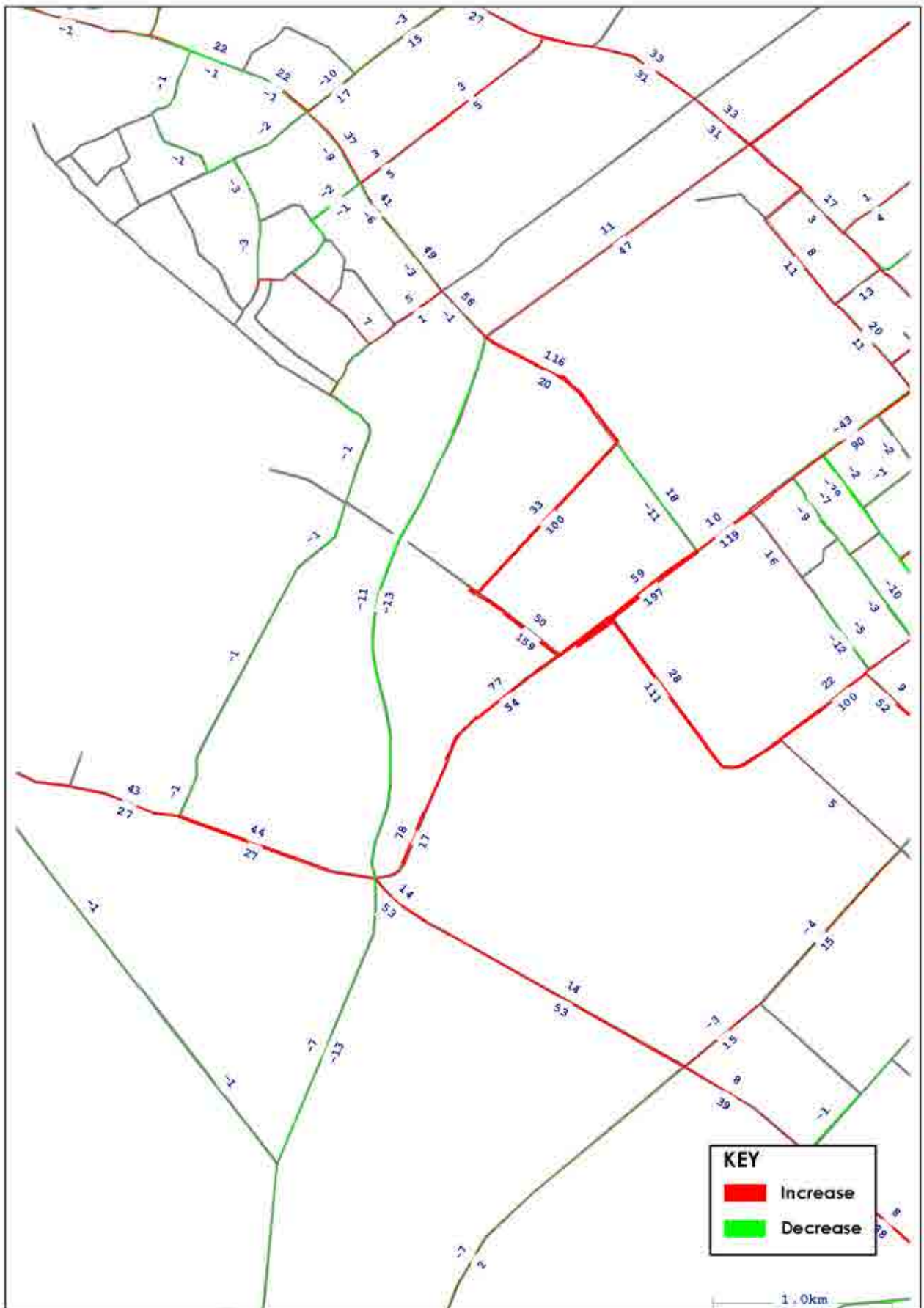

Hawke's Bay Irongate Modelling	2016 AM Peak Irongate with Link Road Stage 1+ Development Change in Traffic Volumes to 2016 Base	Figure 13
Gabites Porter Consultants		

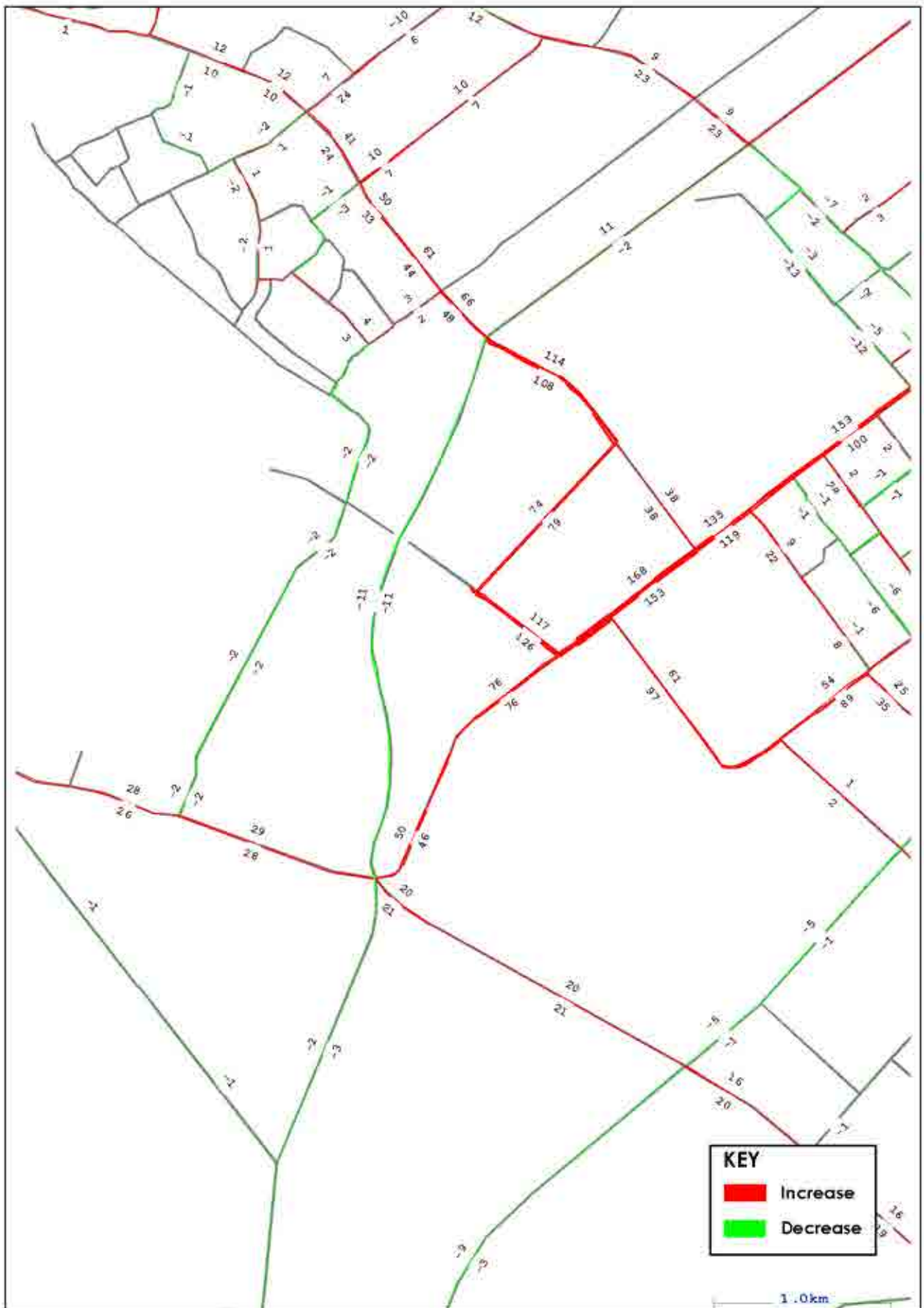

Hawke's Bay Irongate Modelling	2016 SH Peak Irongate with Link Road Stage 1+ Development Change in Traffic Volumes to 2016 Base	Figure 14
Gabites Porter Consultants		

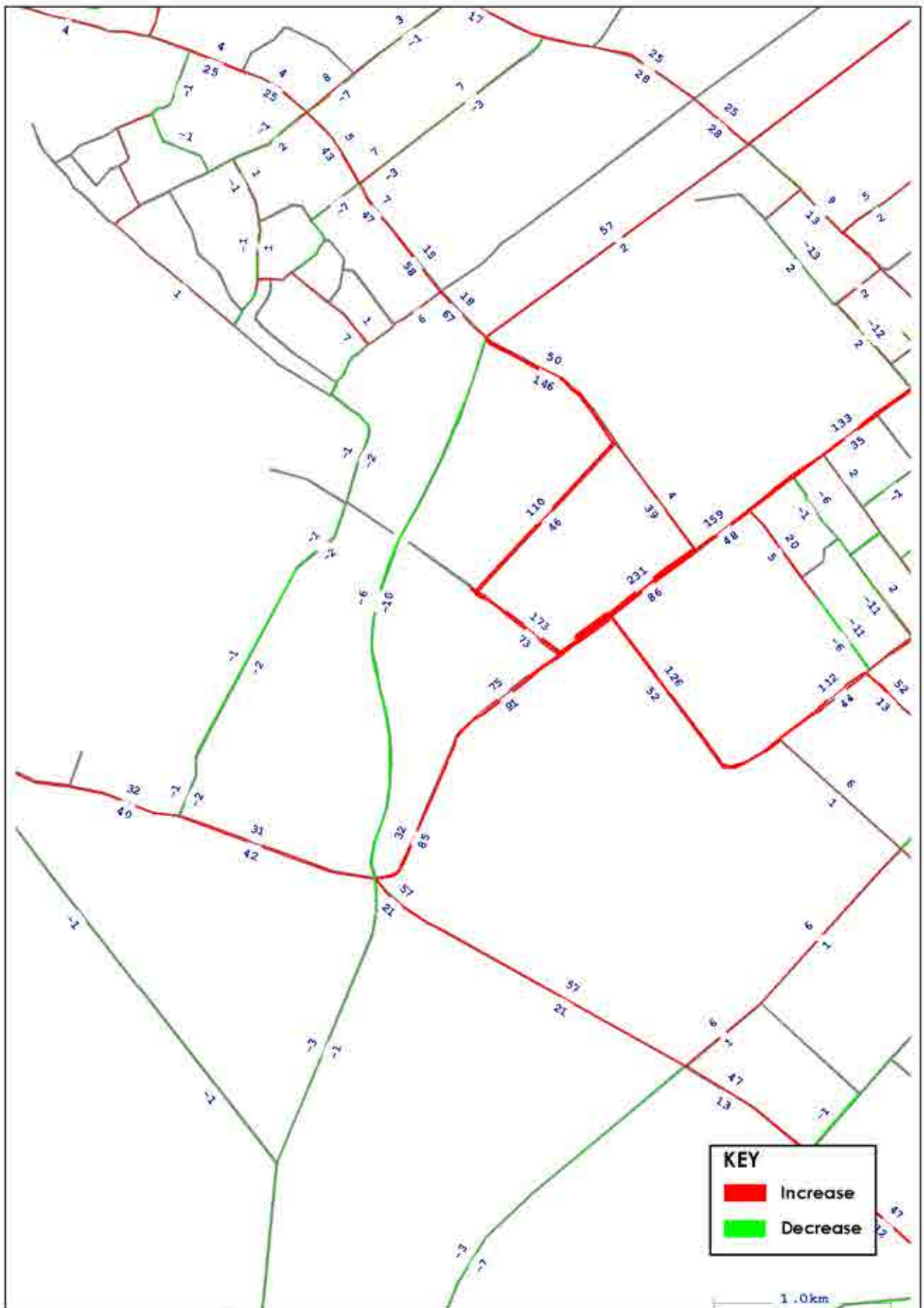

Hawke's Bay Irongate Modelling Gabites Porter Consultants	2016 PM Peak Irongate with Link Road Stage 1+ Development Change in Traffic Volumes to 2016 Base	Figure 15
--	---	------------------

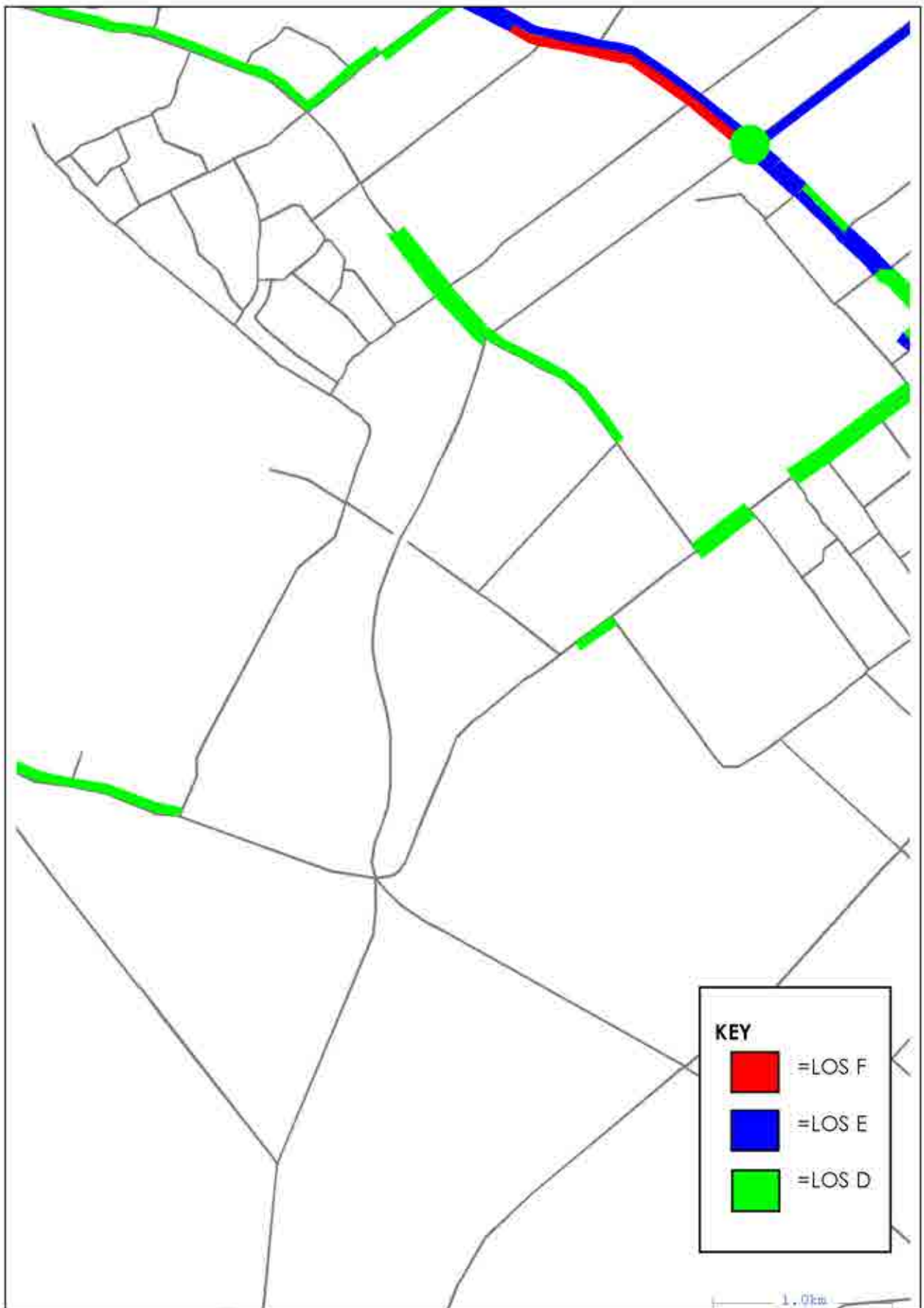

Hawke's Bay Irongate Modelling Gabites Porter Consultants	2016 AM Peak Irongate with Link Road Stage 1+ Development Level of Service	Figure 16
--	---	------------------



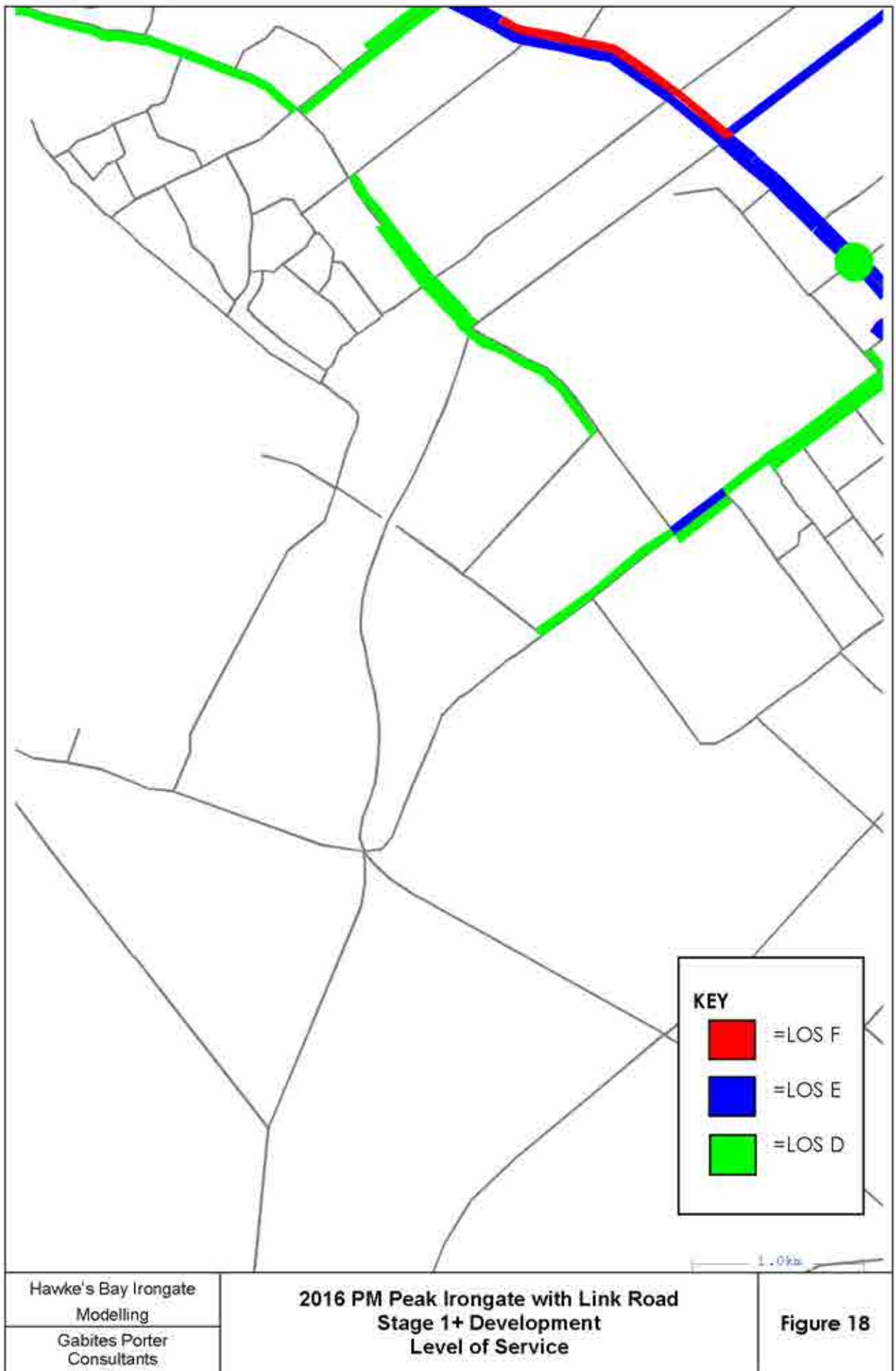

APPENDIX 4

2021 Stage 1:

- With Irongate development
- With Irongate + York Rd Link with Irongate Rd
- With Irongate + Left turn off expressway into Irongate Rd

1. 2021 AM Peak Irongate Stage 1 Development Traffic Volumes	1
2. 2021 SH Peak Irongate Stage 1 Development Traffic Volumes	2
3. 2021 PM Peak Irongate Stage 1 Development Traffic Volumes	3
4. 2021 AM Peak Irongate Stage 1 Development Change in Traffic Volumes to 2021 Base	4
5. 2021 SH Peak Irongate Stage 1 Development Change in Traffic Volumes to 2021 Base	5
6. 2021 PM Peak Irongate Stage 1 Development Change in Traffic Volumes to 2021 Base	6
7. 2021 AM Peak Irongate Stage 1 Development Level of Service	7
8. 2021 SH Peak Irongate Stage 1 Development Level of Service	8
9. 2021 PM Peak Irongate Stage 1 Development Level of Service	9
10. 2021 AM Peak Irongate with Link Road Stage 1 Development Traffic Volumes	10
11. 2021 SH Peak Irongate with Link Road Stage 1 Development Traffic Volumes	11
12. 2021 PM Peak Irongate with Link Road Stage 1 Development Traffic Volumes	12
13. 2021 AM Peak Irongate with Link Road Stage 1 Development Change in Traffic Volumes to 2021 Base	13
14. 2021 SH Peak Irongate with Link Road Stage 1 Development Change in Traffic Volumes to 2021 Base	14
15. 2021 PM Peak Irongate with Link Road Stage 1 Development Change in Traffic Volumes to 2021 Base	15
16. 2021 AM Peak Irongate with Link Road Stage 1 Development Level of Service	16
17. 2021 SH Peak Irongate with Link Road Stage 1 Development Level of Service	17
18. 2021 PM Peak Irongate with Link Road Stage 1 Development Level of Service	18

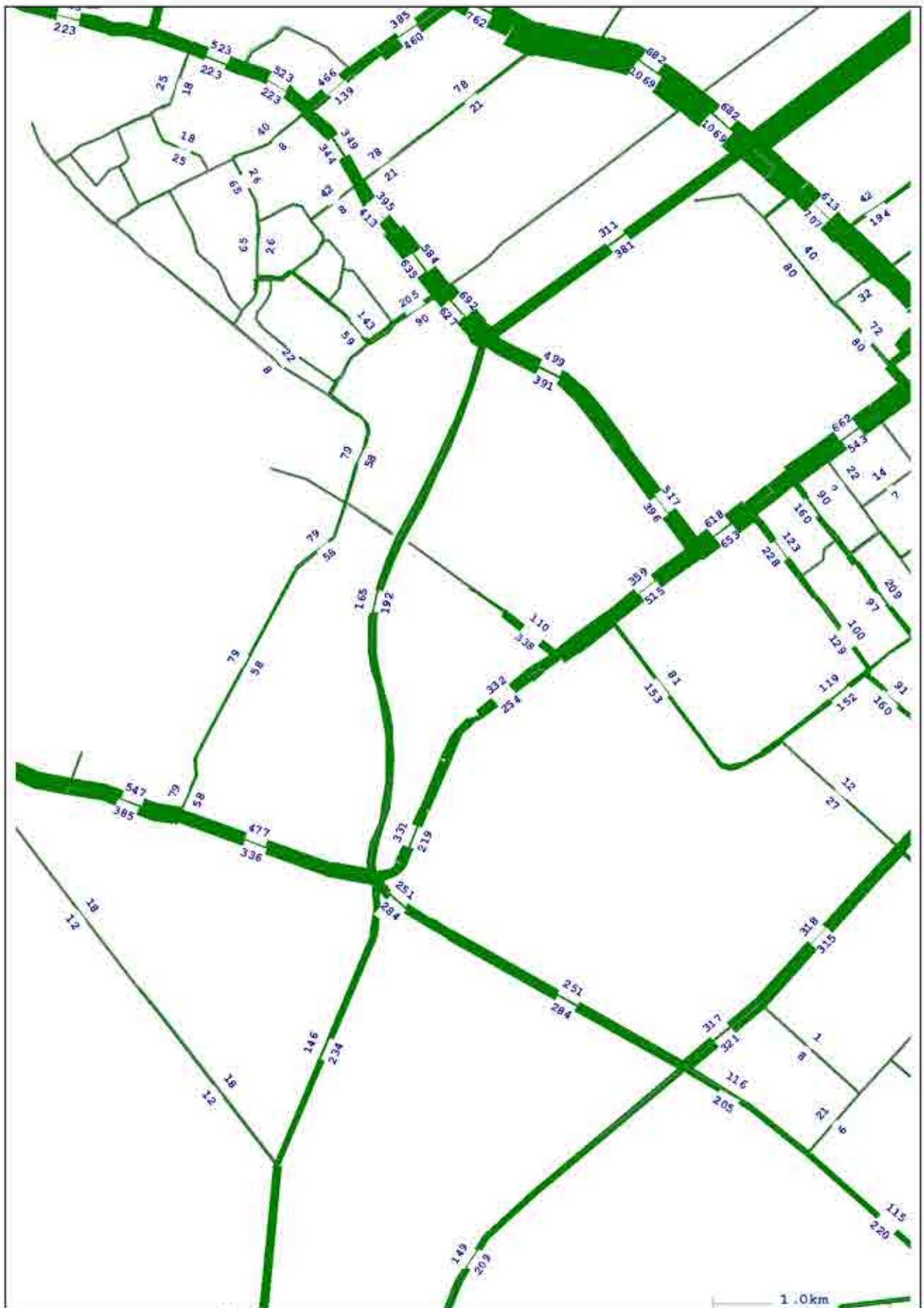

Hawke's Bay Irongate Modelling	2021 AM Peak Irongate Stage 1 Development Traffic Volumes	Figure 1
Gabites Porter Consultants		

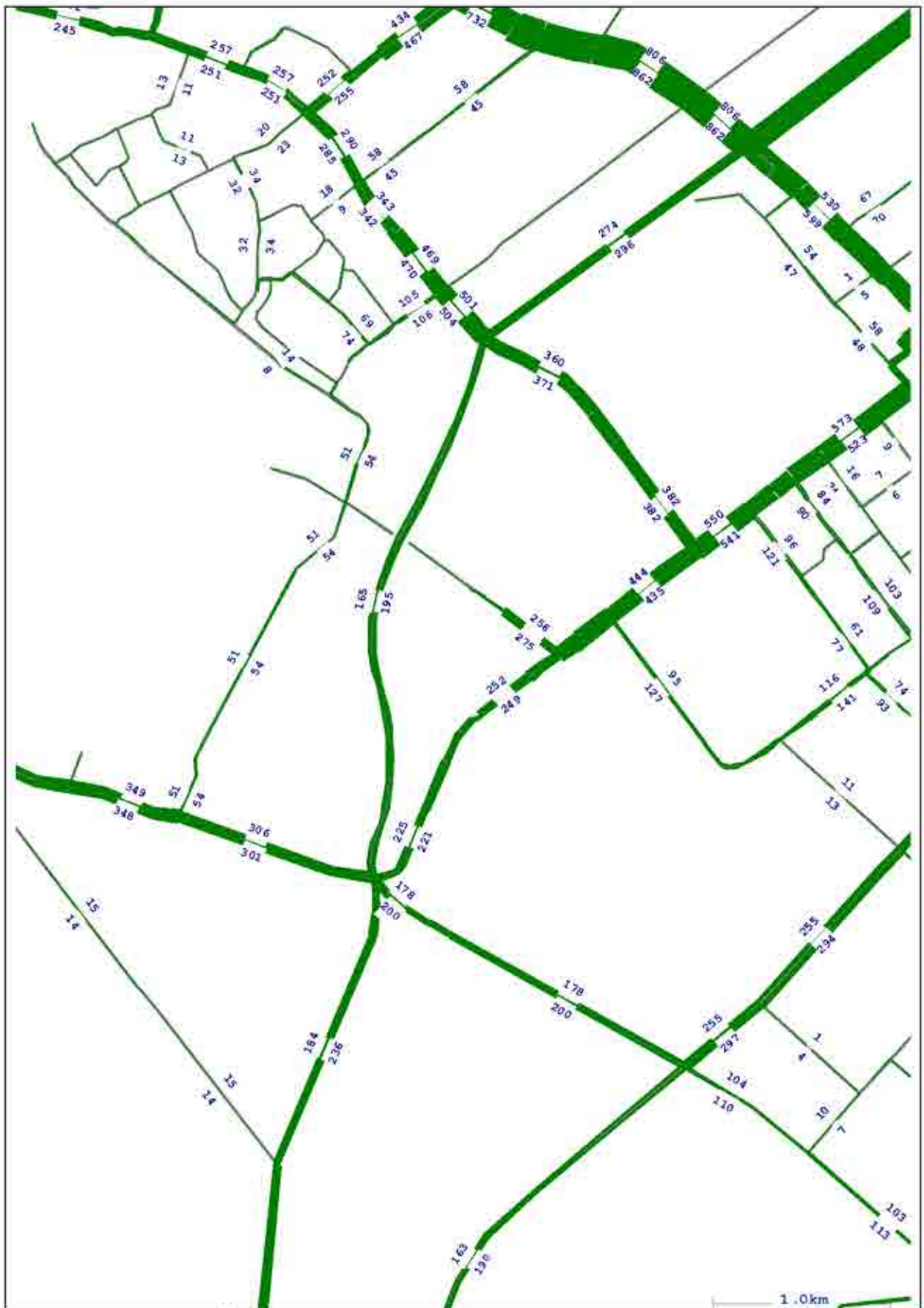

Hawke's Bay Irongate Modelling	2021 SH Peak Irongate Stage 1 Development Traffic Volumes	Figure 2
Gabites Porter Consultants		

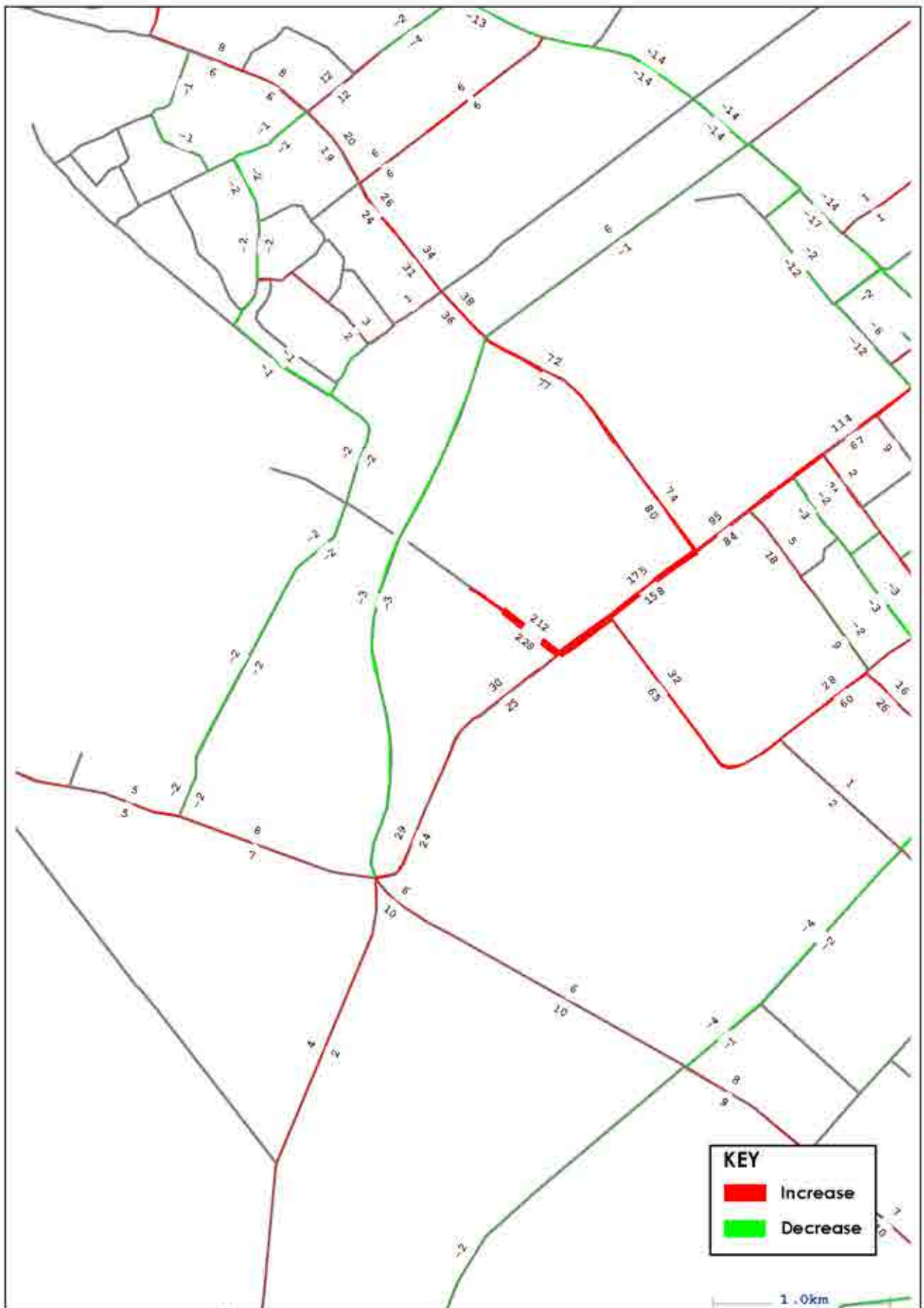

Hawke's Bay Irongate Modelling	2021 SH Peak Irongate Stage 1 Development Change in Traffic Volumes to 2021 Base	Figure 5
Gabites Porter Consultants		

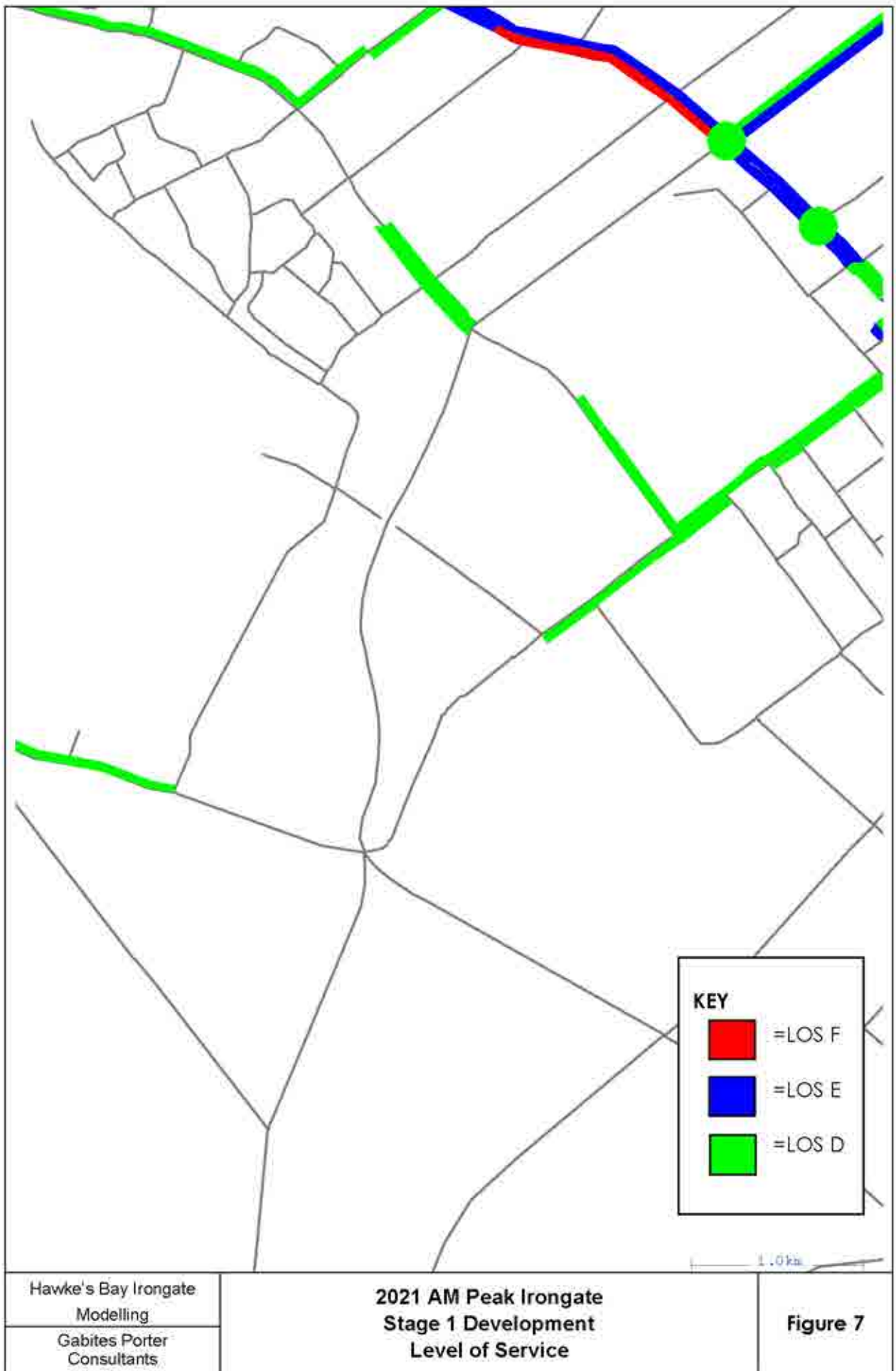



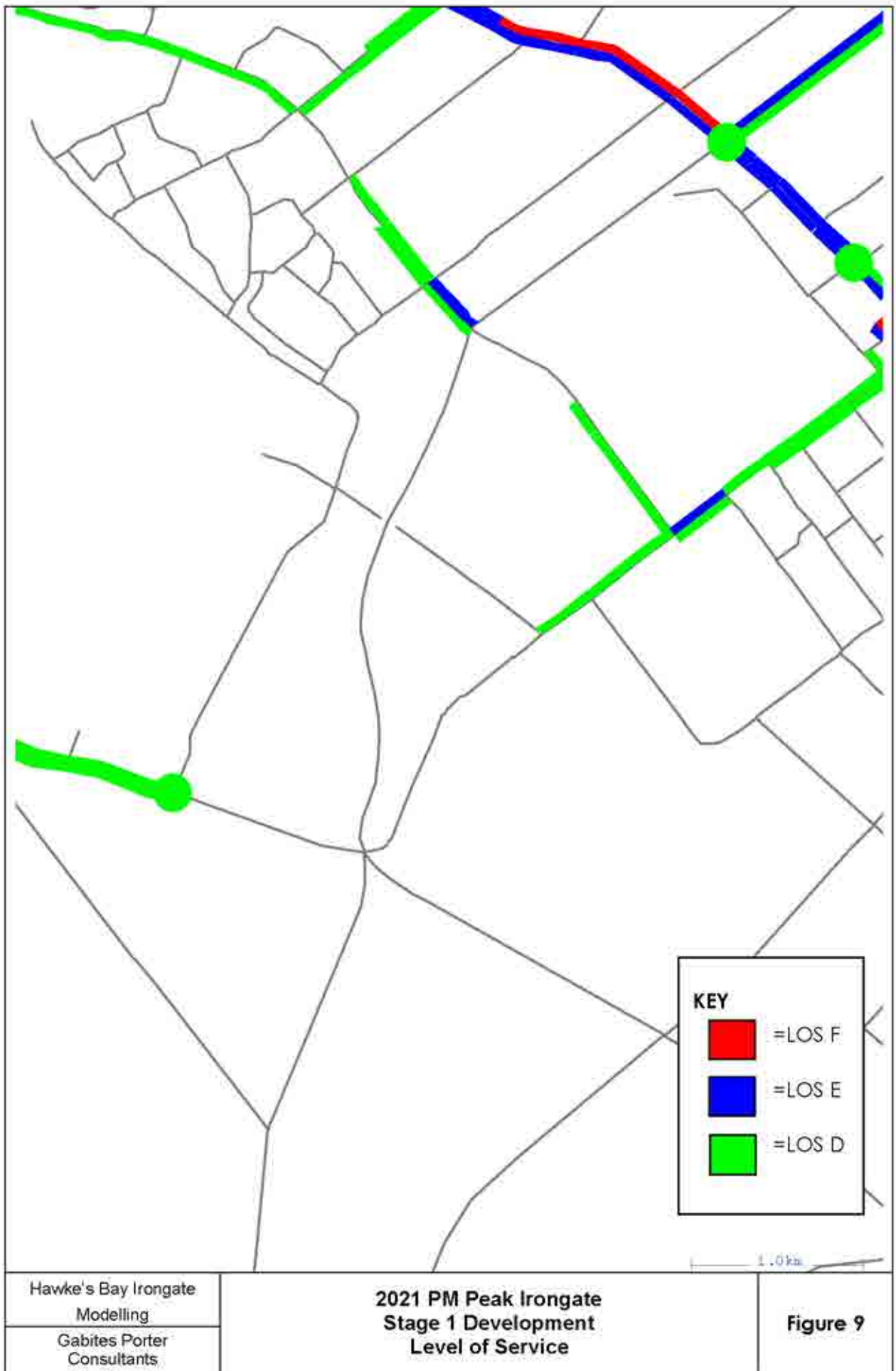

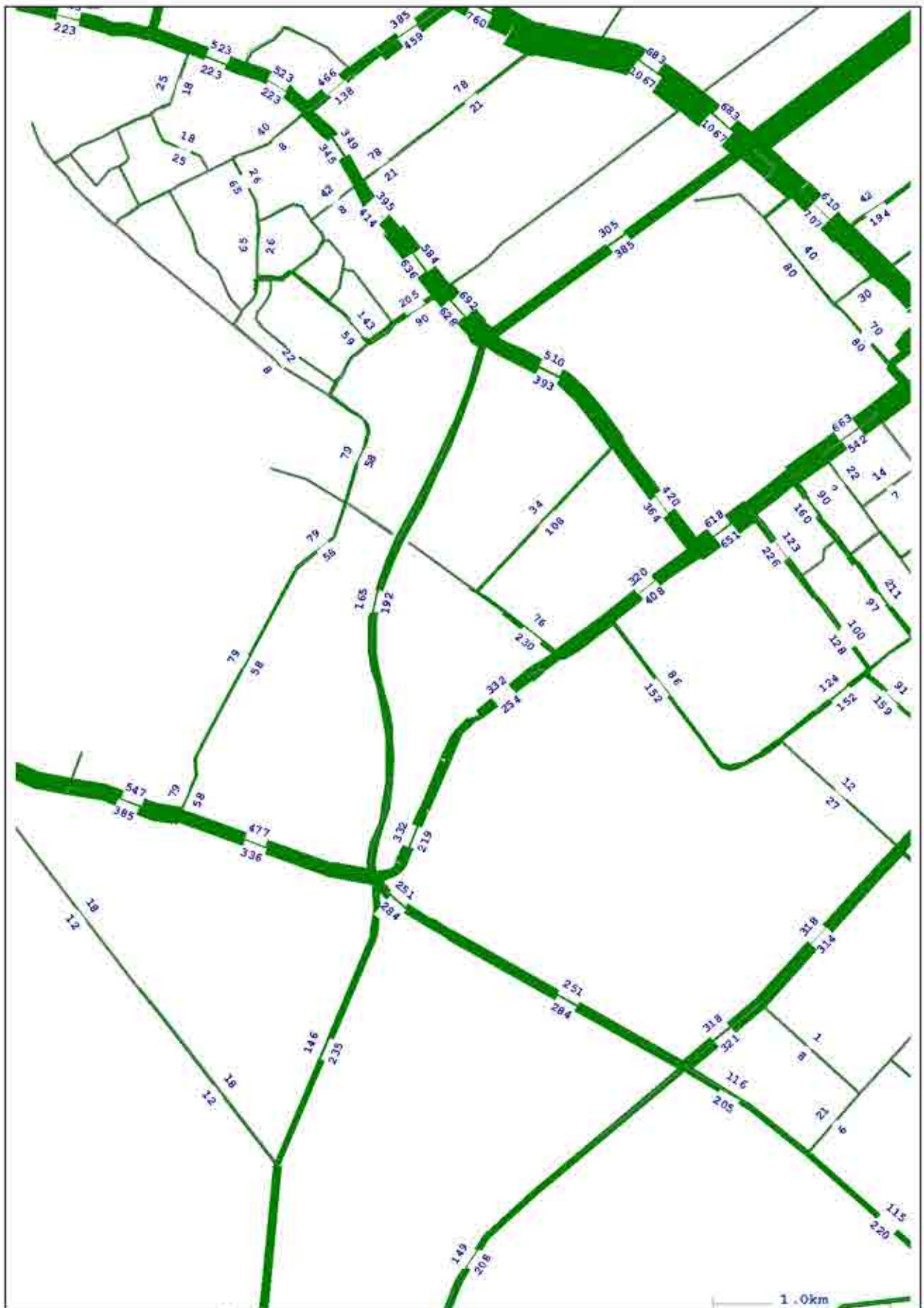

Hawke's Bay Irongate Modelling	2021 AM Peak Irongate with Link Road Stage 1 Development Traffic Volumes	Figure 10
Gabites Porter Consultants		

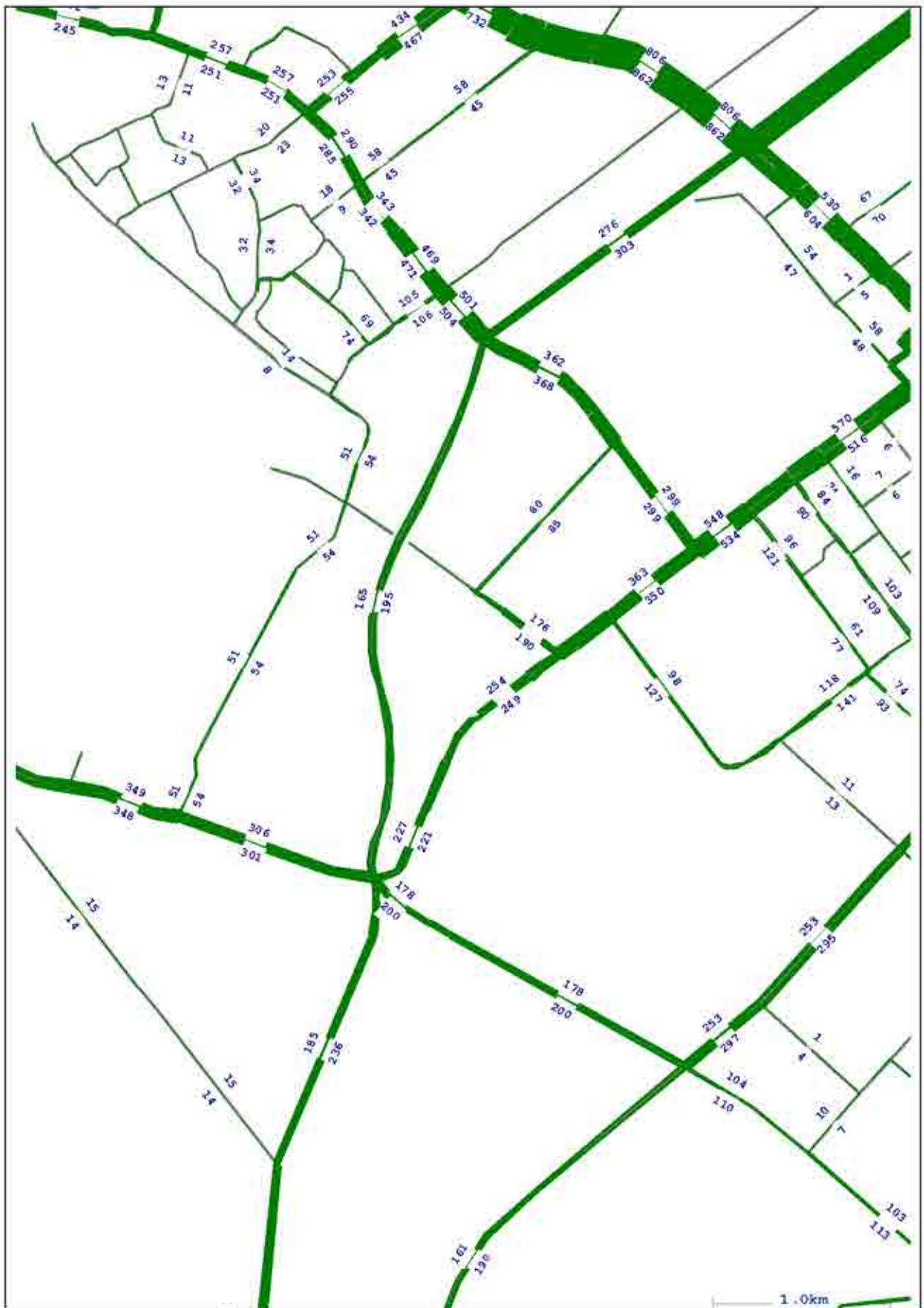

Hawke's Bay Irongate Modelling	2021 SH Peak Irongate with Link Road Stage 1 Development Traffic Volumes	Figure 11
Gabites Porter Consultants		

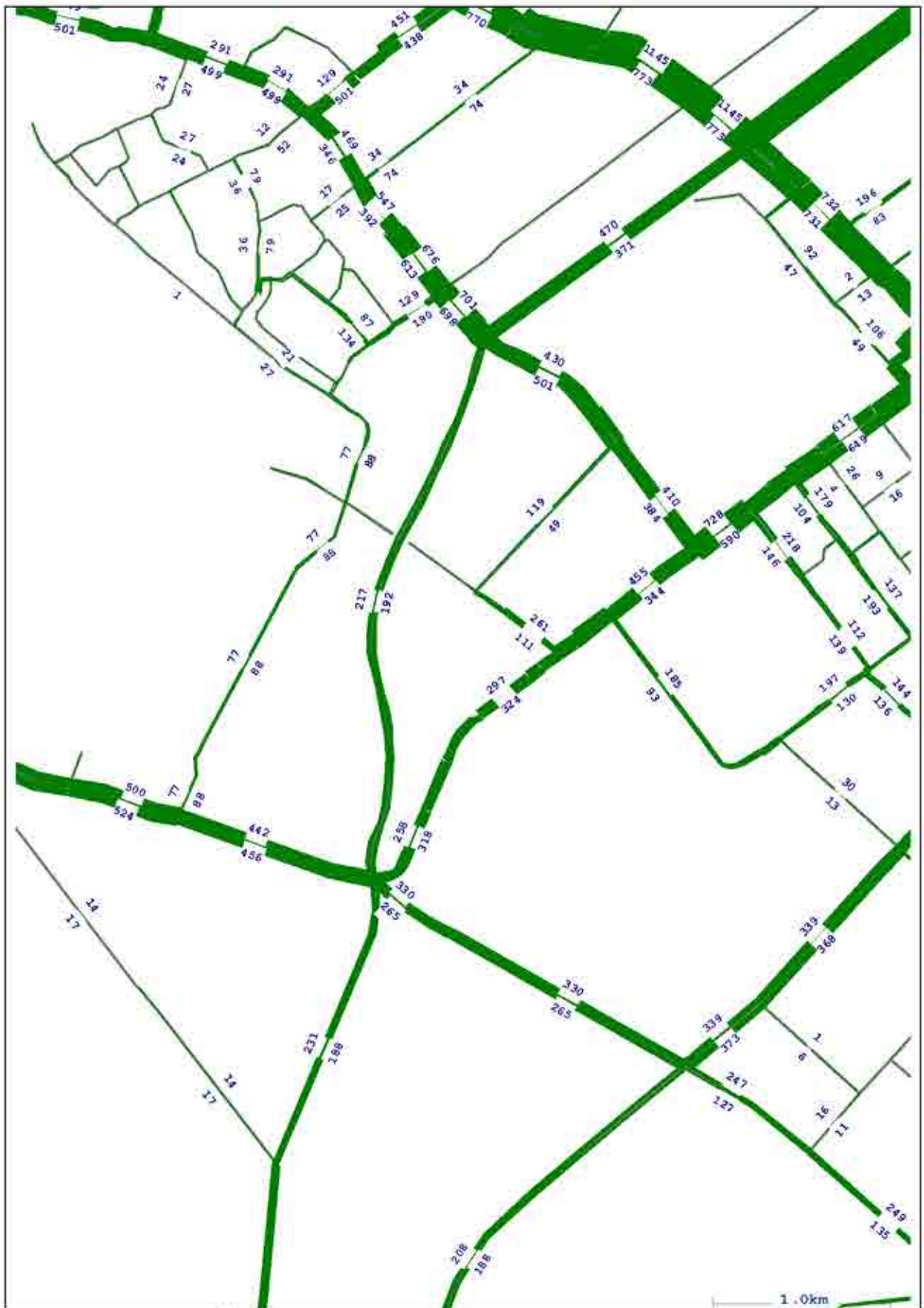

Hawke's Bay Irongate Modelling	2021 PM Peak Irongate with Link Road Stage 1 Development Traffic Volumes	Figure 12
Gabites Porter Consultants		

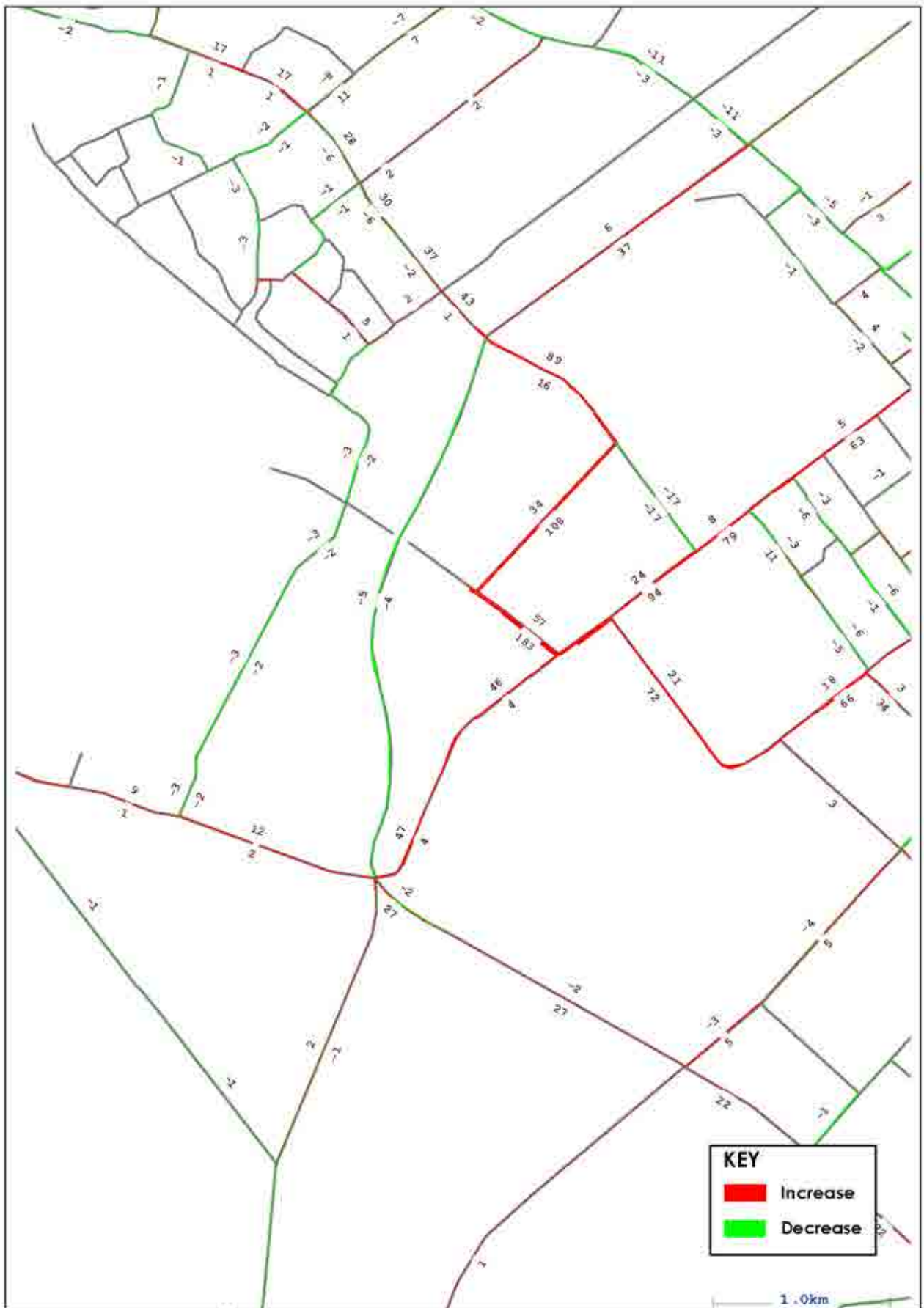

Hawke's Bay Irongate Modelling	2021 AM Peak Irongate with Link Road Stage 1 Development Change in Traffic Volumes to 2021 Base	Figure 13
Gabites Porter Consultants		

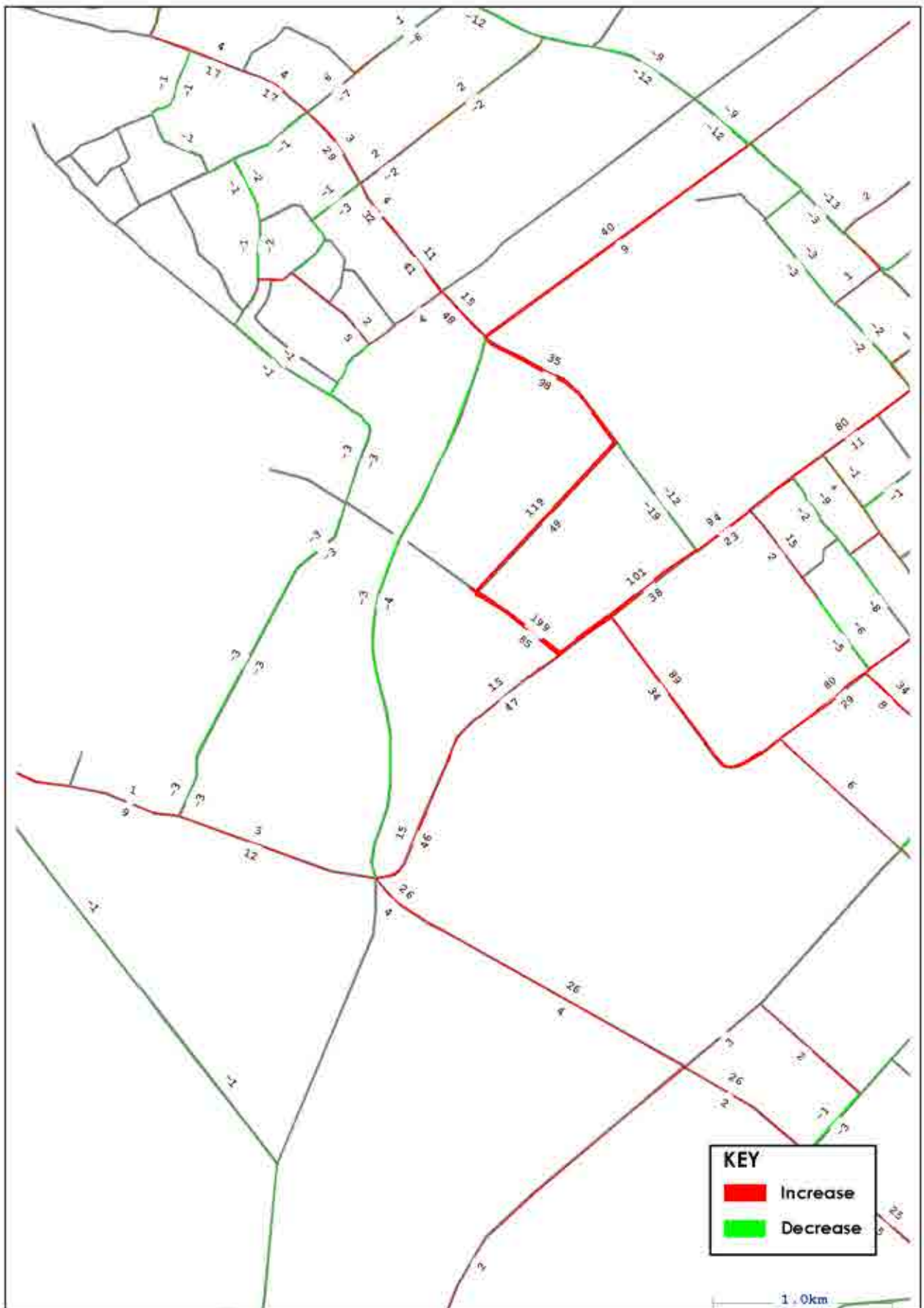

Hawke's Bay Irongate Modelling Gabites Porter Consultants	2021 PM Peak Irongate with Link Road Stage 1 Development Change in Traffic Volumes to 2021 Base	Figure 15
--	--	------------------

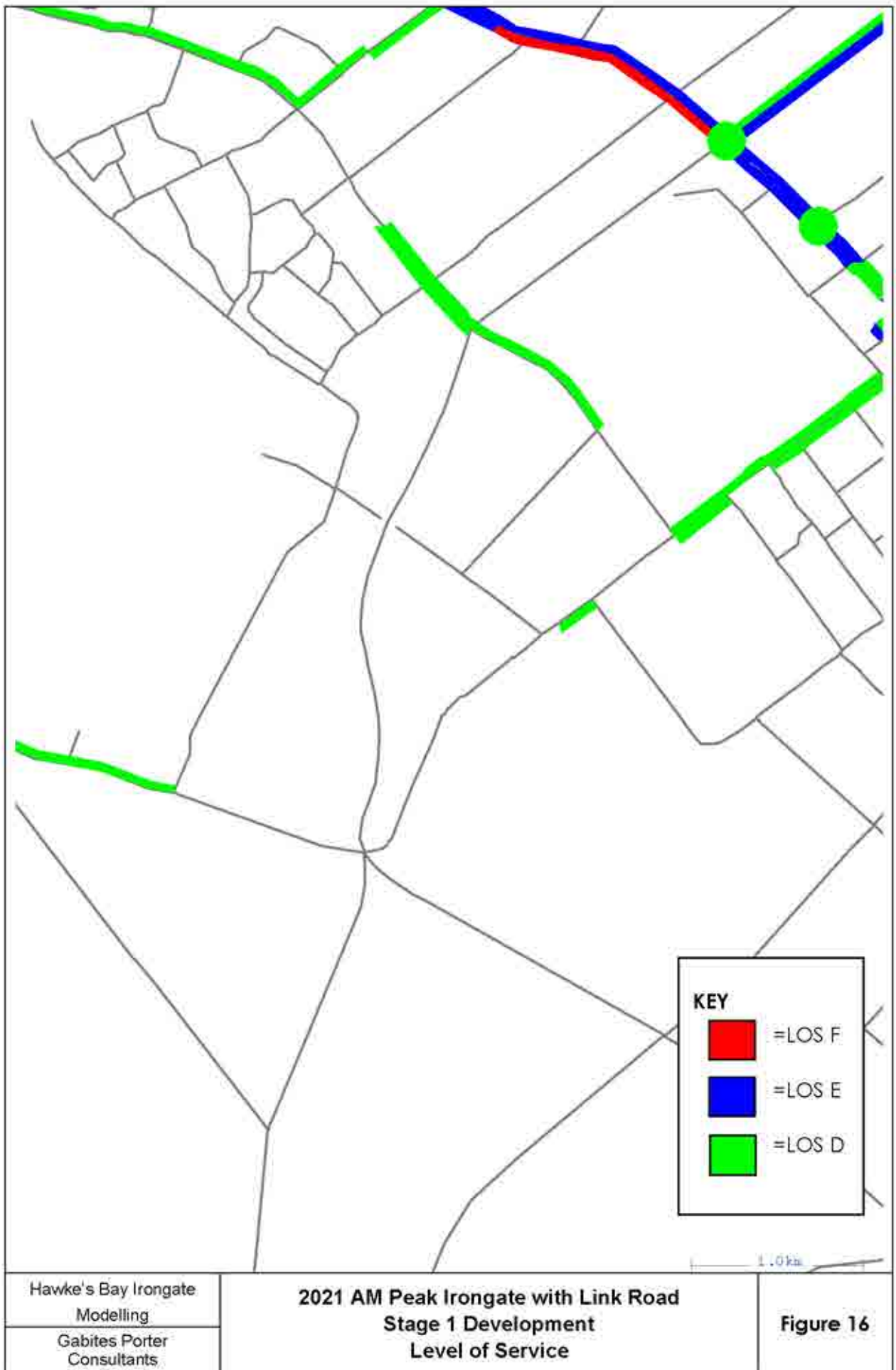

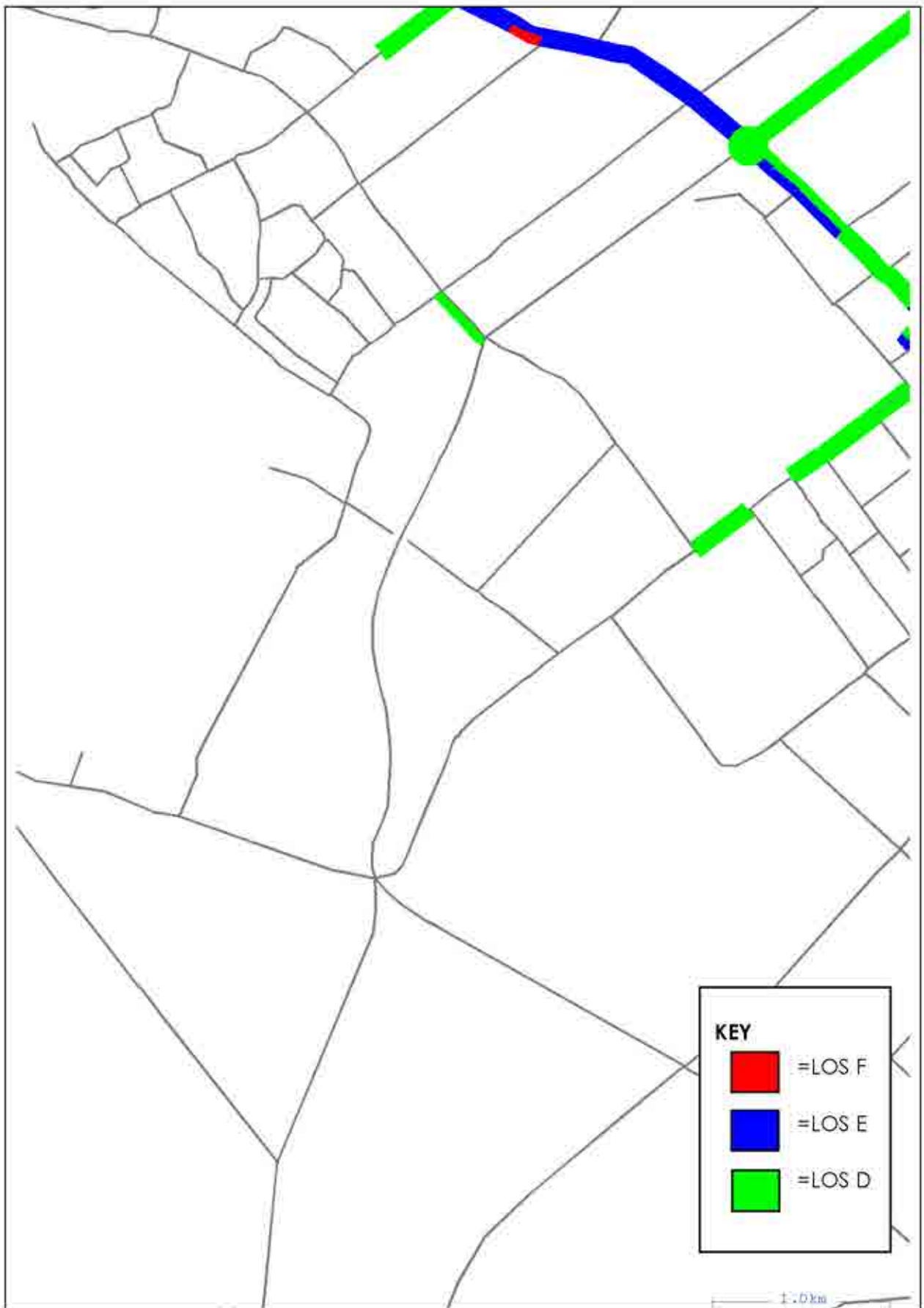

Hawke's Bay Irongate Modelling Gabites Porter Consultants	2021 SH Peak Irongate with Link Road Stage 1 Development Level of Service	Figure 17
--	--	------------------

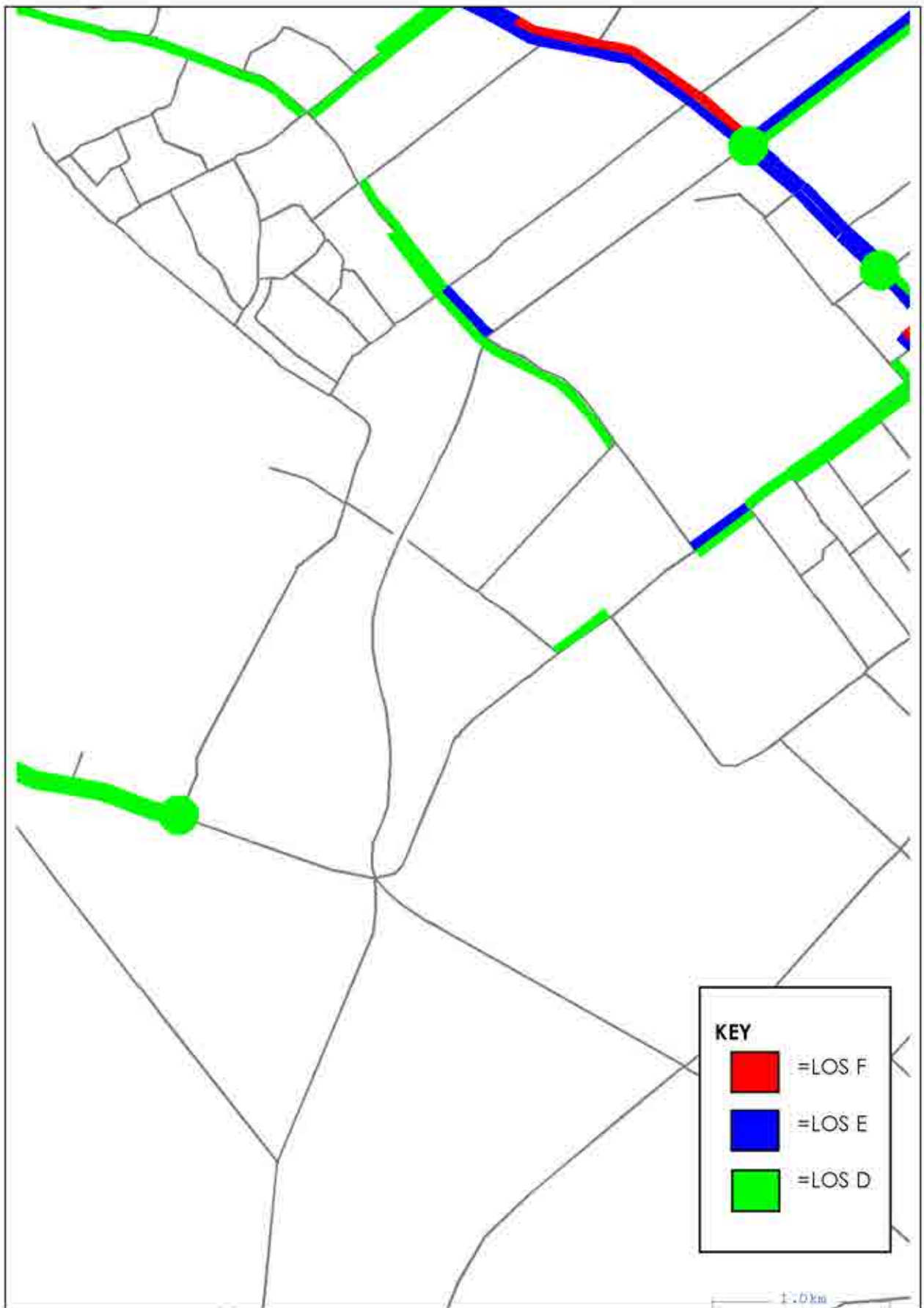

Hawke's Bay Irongate Modelling Gabites Porter Consultants	2021 PM Peak Irongate with Link Road Stage 1 Development Level of Service	Figure 18
--	--	------------------

APPENDIX 5

2021 Stage 1+:

- With Irongate development
- With Irongate + York Rd Link with Irongate Rd
- With Irongate + Left turn off expressway into Irongate Rd

1. 2021 AM Peak Irongate Stage 1+ Development Traffic Volumes	1
2. 2021 SH Peak Irongate Stage 1+ Development Traffic Volumes	2
3. 2021 PM Peak Irongate Stage 1+ Development Traffic Volumes	3
4. 2021 AM Peak Irongate Stage 1+ Development Change in Traffic Volumes to 2021 Base	4
5. 2021 SH Peak Irongate Stage 1+ Development Change in Traffic Volumes to 2021 Base	5
6. 2021 PM Peak Irongate Stage 1+ Development Change in Traffic Volumes to 2021 Base	6
7. 2021 AM Peak Irongate Stage 1+ Development Level of Service	7
8. 2021 SH Peak Irongate Stage 1+ Development Level of Service	8
9. 2021 PM Peak Irongate Stage 1+ Development Level of Service	9
10. 2021 AM Peak Irongate with Link Road Stage 1+ Development Traffic Volumes	10
11. 2021 SH Peak Irongate with Link Road Stage 1+ Development Traffic Volumes	11
12. 2021 PM Peak Irongate with Link Road Stage 1+ Development Traffic Volumes	12
13. 2021 AM Peak Irongate with Link Road Stage 1+ Development Change in Traffic Volumes to 2021 Base	13
14. 2021 SH Peak Irongate with Link Road Stage 1+ Development Change in Traffic Volumes to 2021 Base	14
15. 2021 PM Peak Irongate with Link Road Stage 1+ Development Change in Traffic Volumes to 2021 Base	15
16. 2021 AM Peak Irongate with Link Road Stage 1+ Development Level of Service	16
17. 2021 SH Peak Irongate with Link Road Stage 1+ Development Level of Service	17
18. 2021 PM Peak Irongate with Link Road Stage 1+ Development Level of Service	18

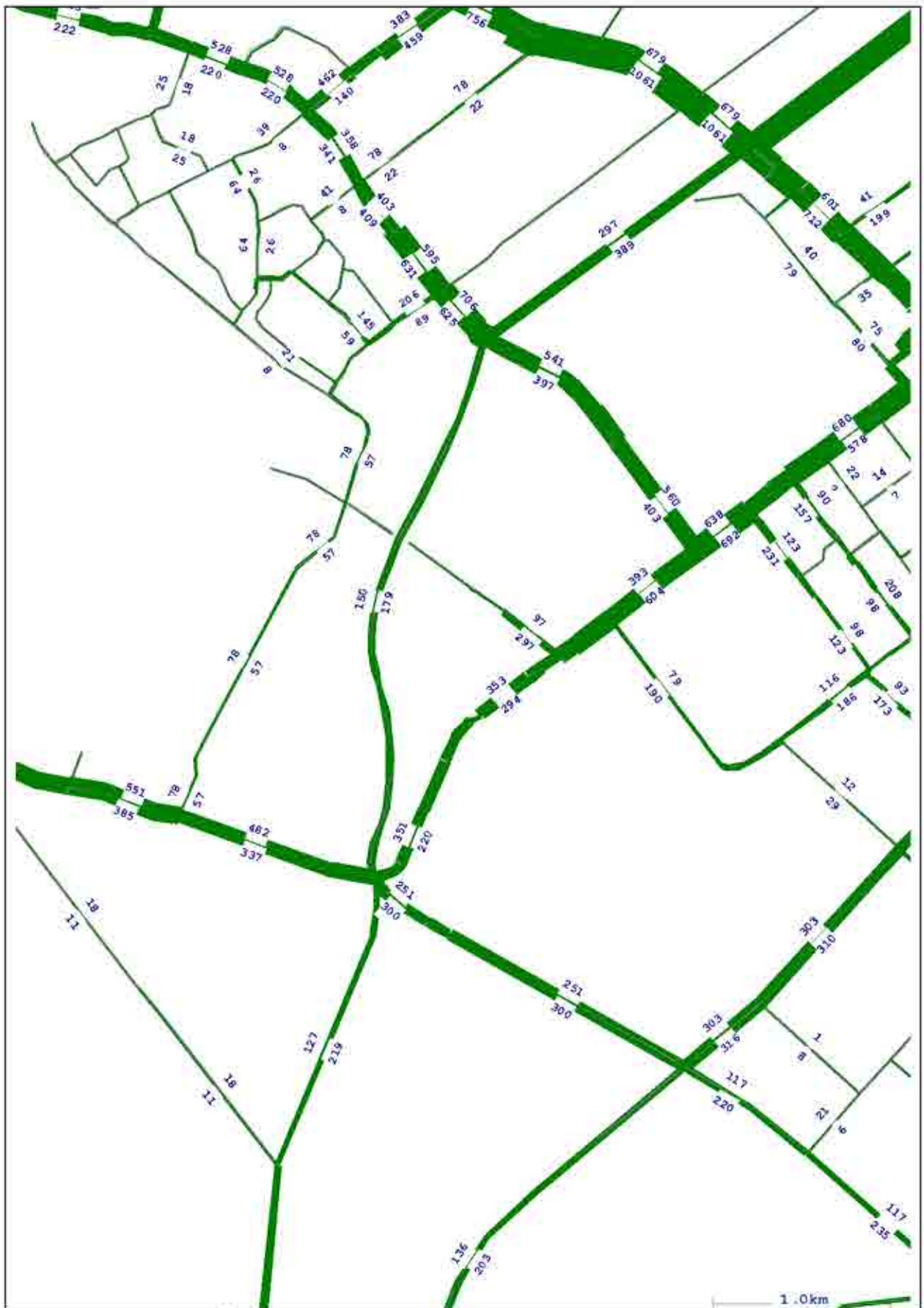

Hawke's Bay Irongate Modelling	2021 AM Peak Irongate Stage 1+ Development Traffic Volumes	Figure 1
Gabites Porter Consultants		

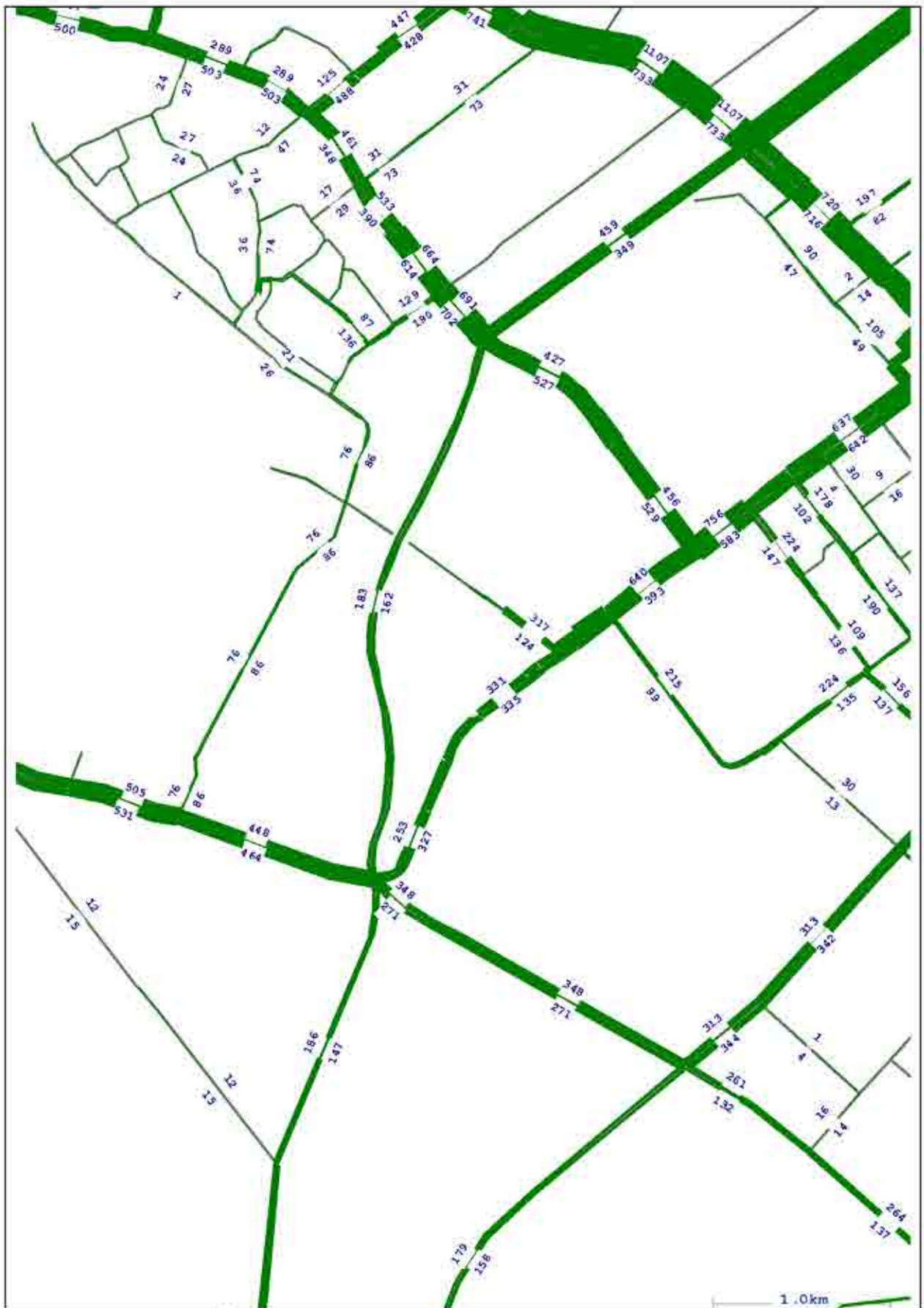

Hawke's Bay Irongate Modelling	2021 PM Peak Irongate Stage 1+ Development Traffic Volumes	Figure 3
Gabites Porter Consultants		

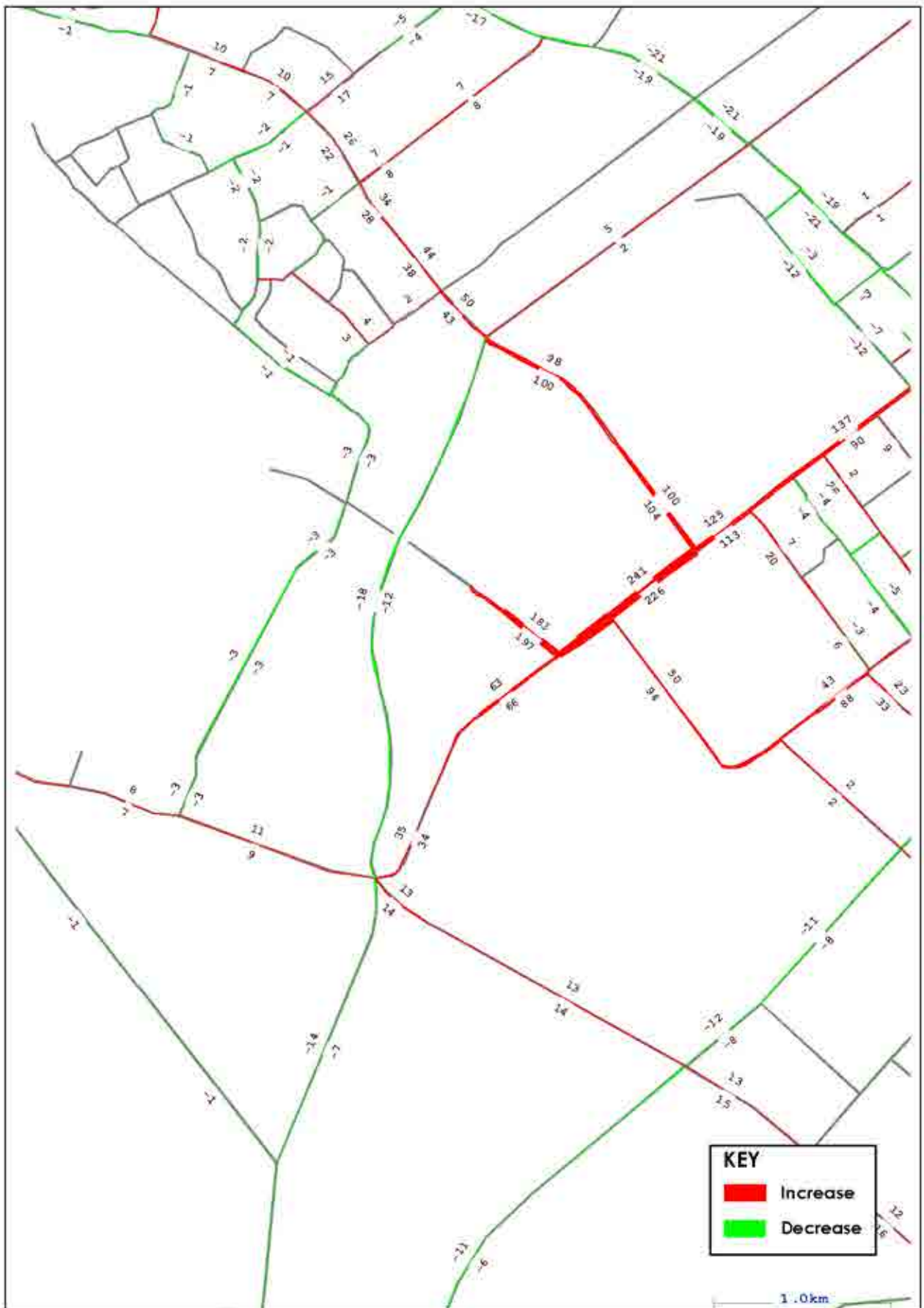

Hawke's Bay Irongate Modelling	2021 SH Peak Irongate Stage 1+ Development Change in Traffic Volumes to 2021 Base	Figure 5
Gabites Porter Consultants		

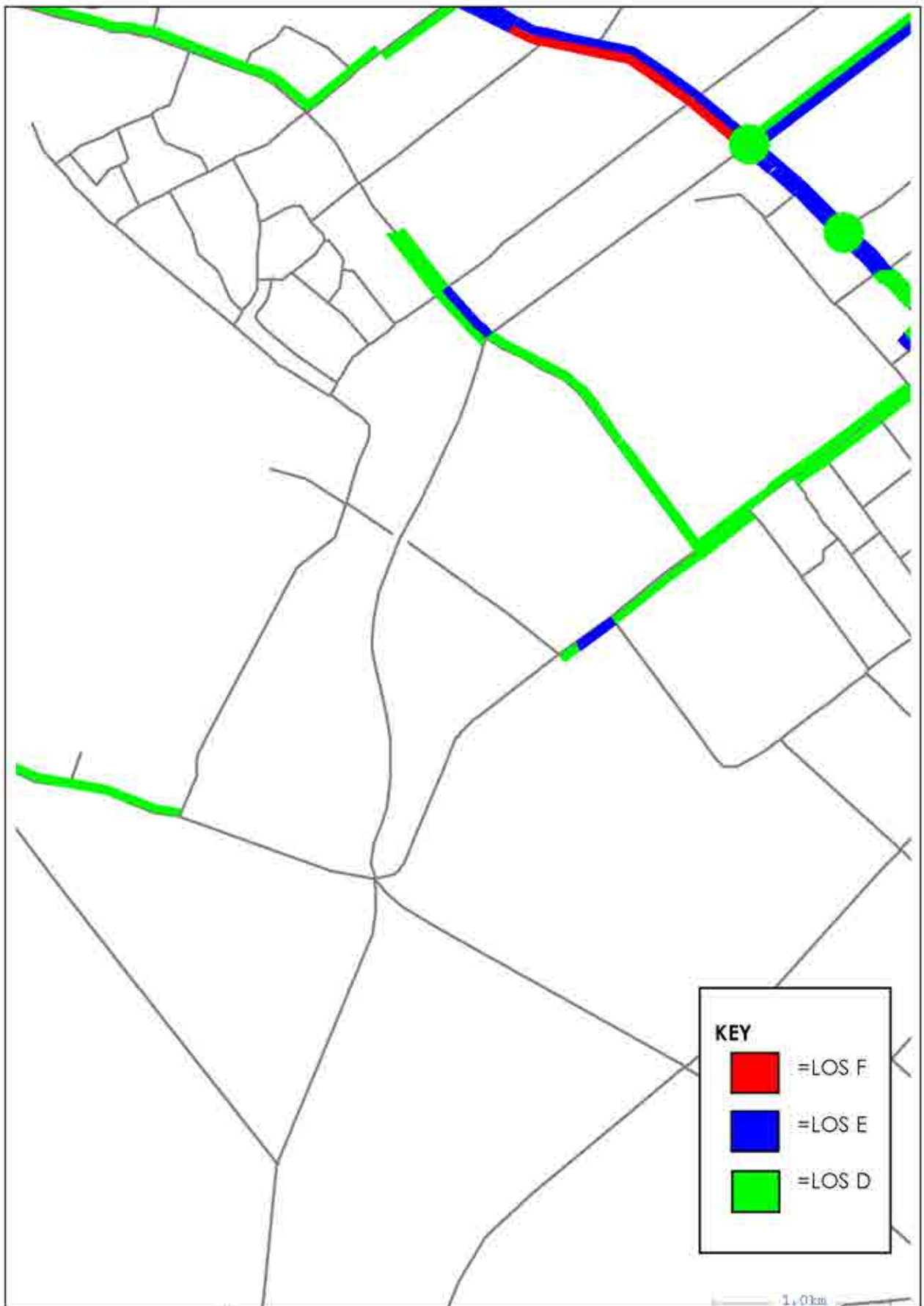

Hawke's Bay Irongate Modelling Gabites Porter Consultants	2021 AM Peak Irongate Stage 1+ Development Level of Service	Figure 7
--	--	-----------------



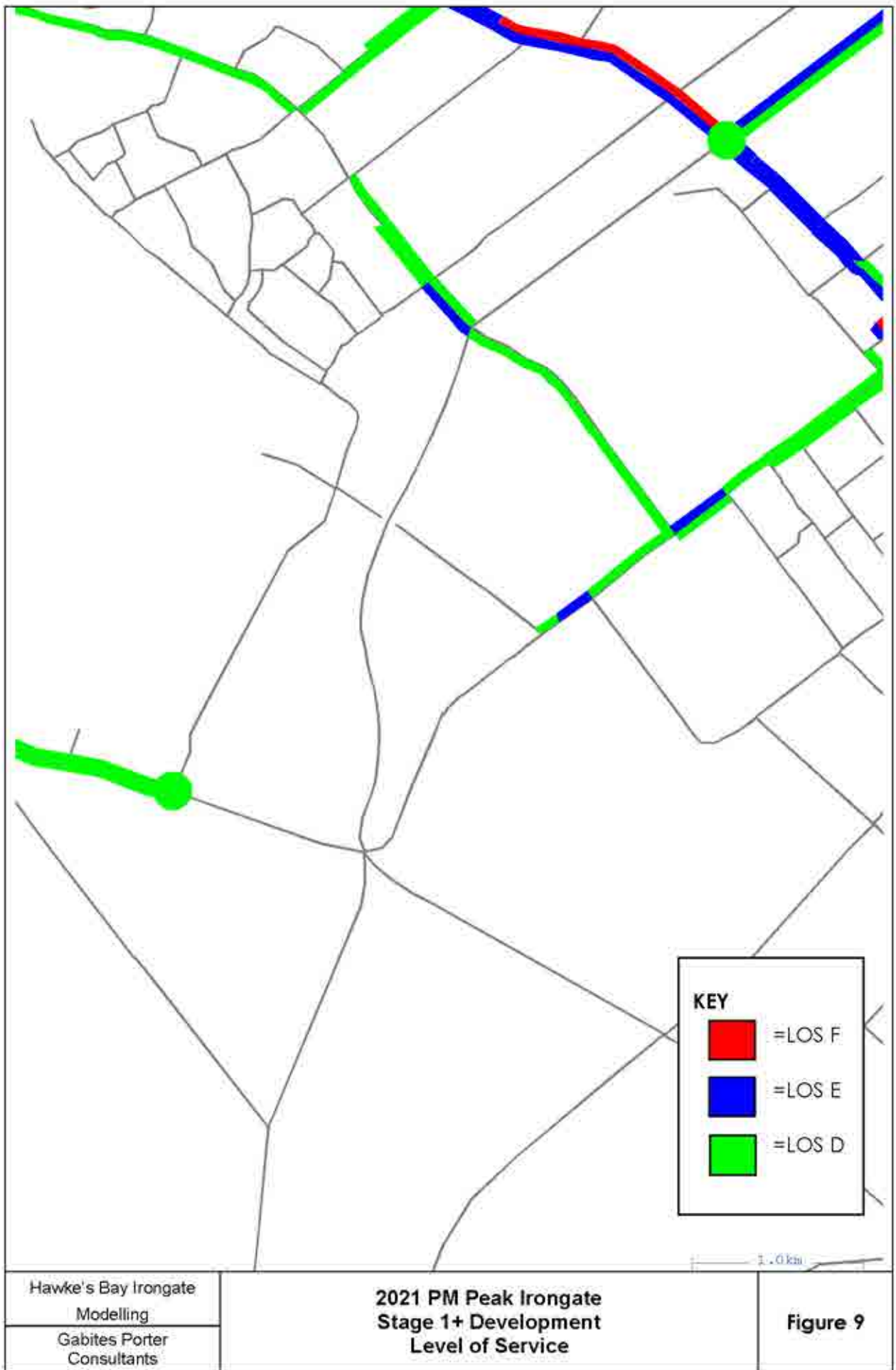

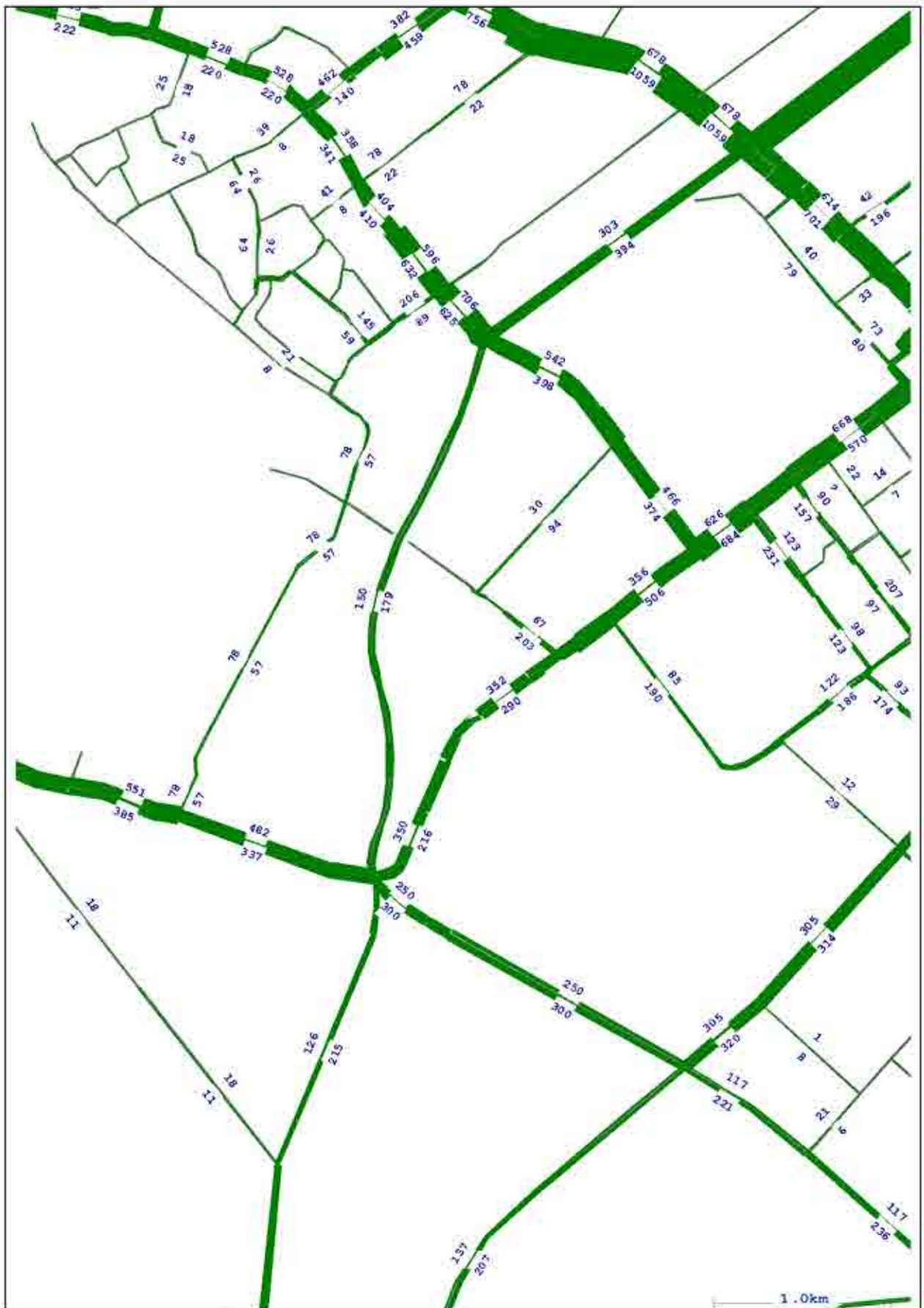

Hawke's Bay Irongate Modelling	2021 AM Peak Irongate with Link Road Stage 1+ Development Traffic Volumes	Figure 10
Gabites Porter Consultants		

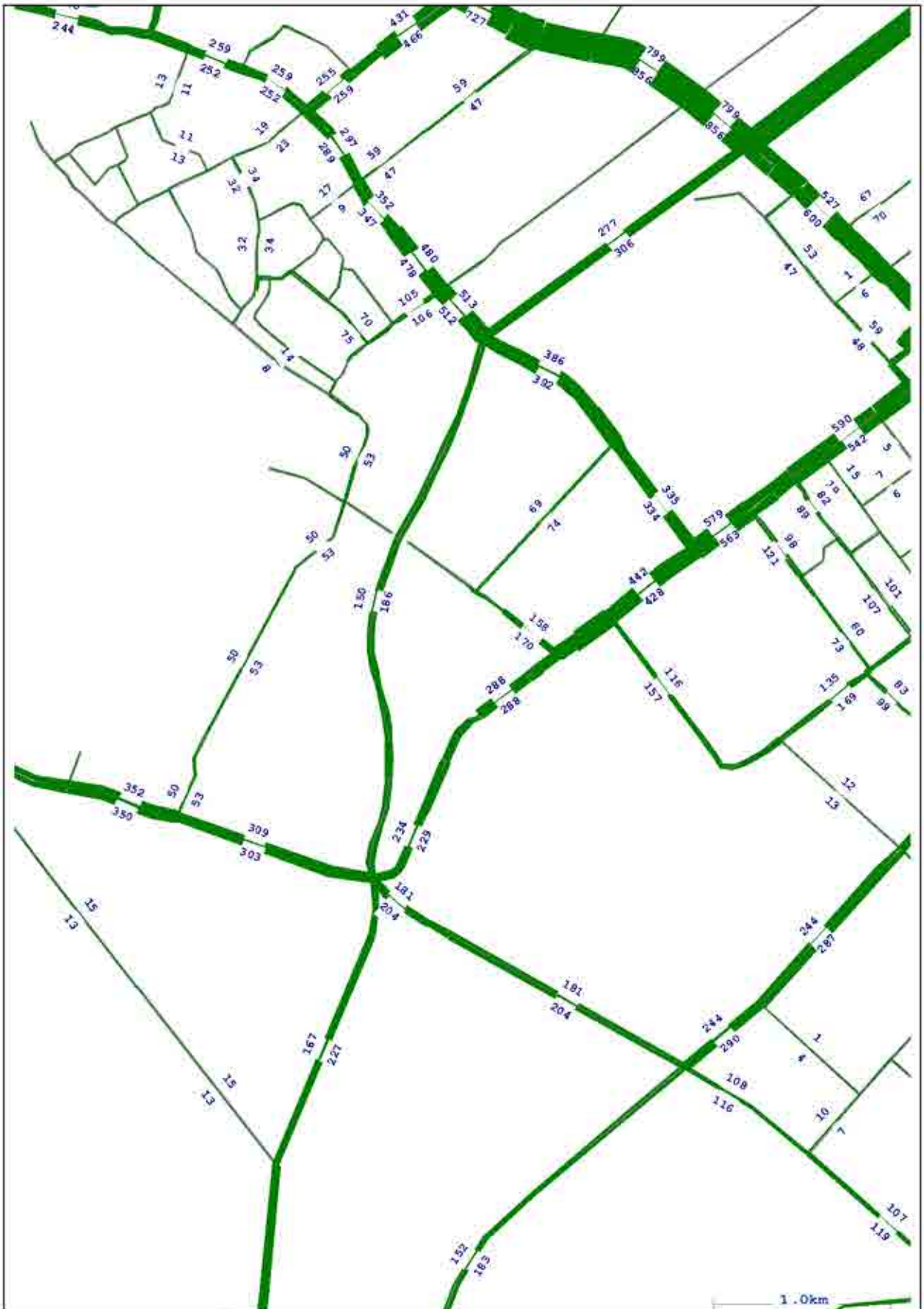

Hawke's Bay Irongate Modelling	2021 SH Peak Irongate with Link Road Stage 1+ Development Traffic Volumes	Figure 11
Gabites Porter Consultants		

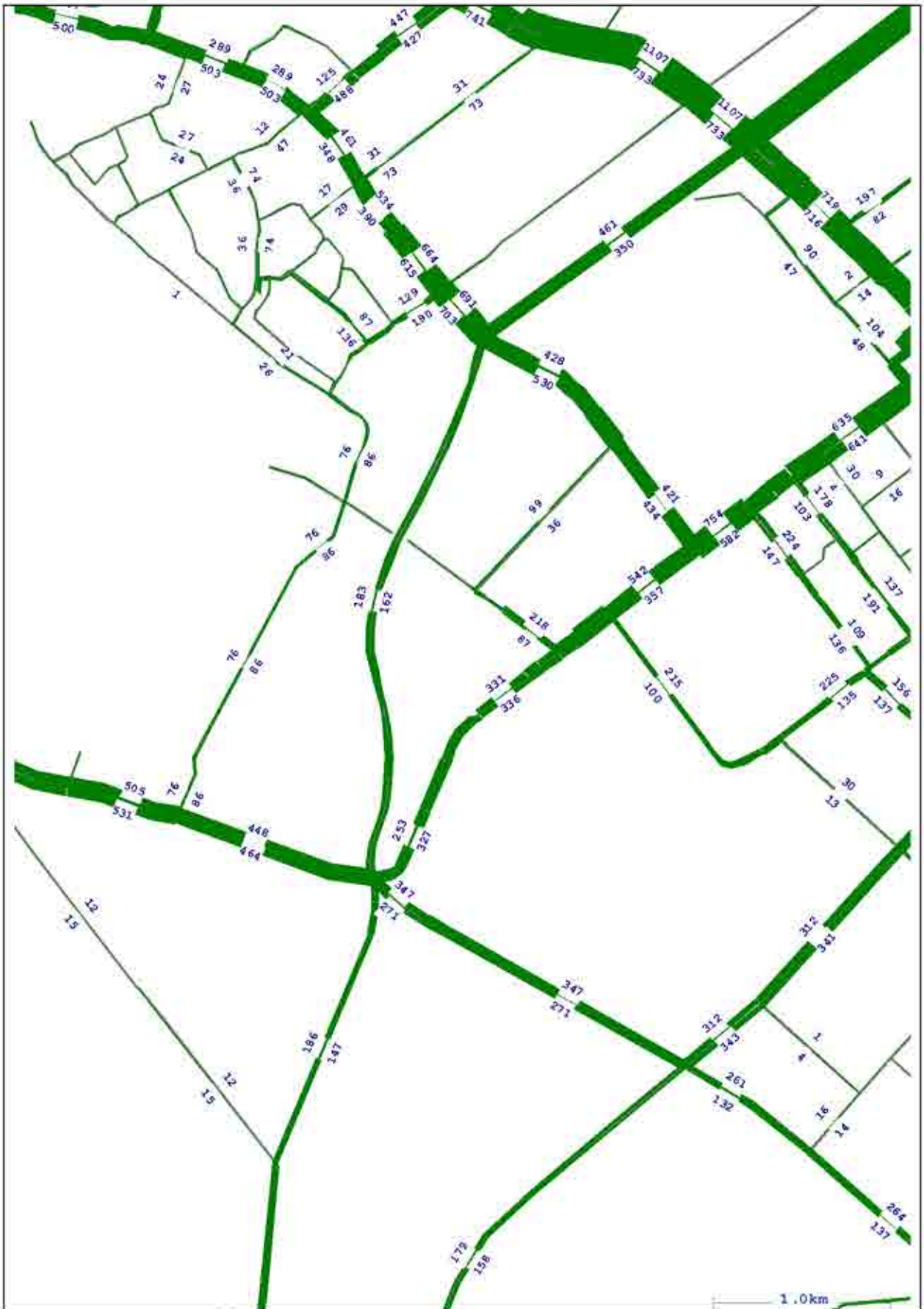

Hawke's Bay Irongate Modelling	2021 PM Peak Irongate with Link Road Stage 1+ Development Traffic Volumes	Figure 12
Gabites Porter Consultants		

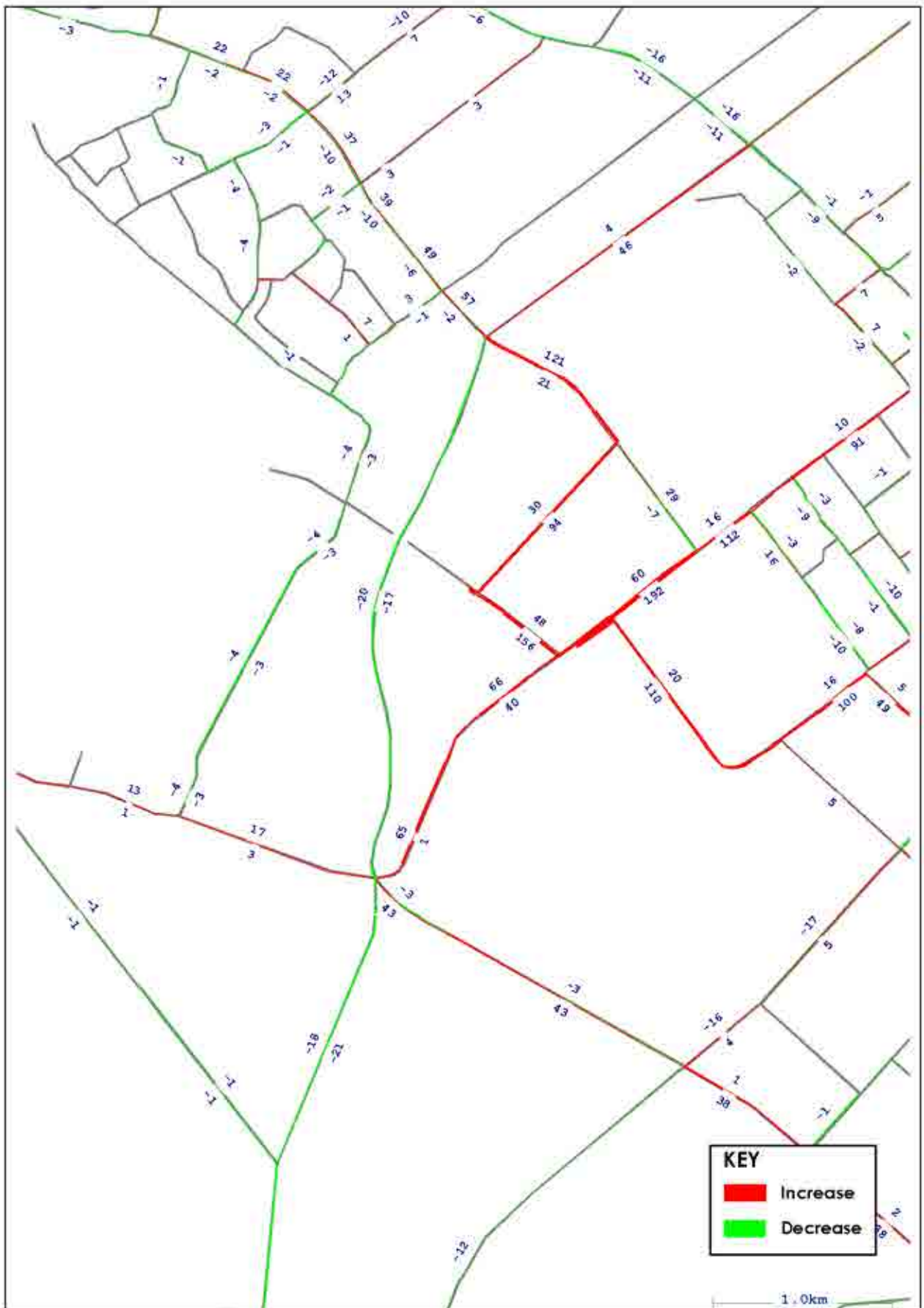

Hawke's Bay Irongate Modelling	2021 AM Peak Irongate with Link Road Stage 1+ Development Change in Traffic Volumes to 2021 Base	Figure 13
Gabites Porter Consultants		

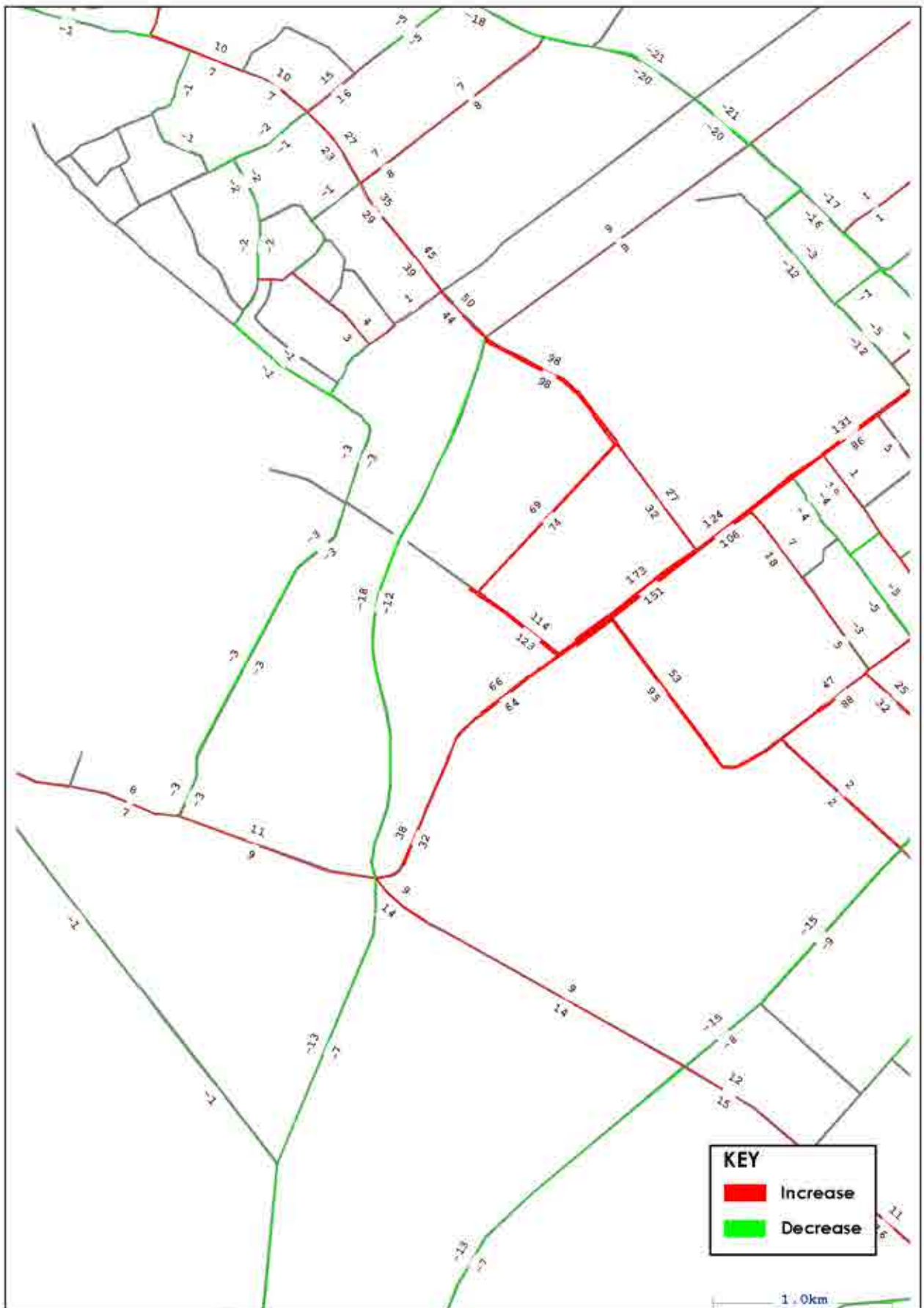

Hawke's Bay Irongate Modelling	2021 SH Peak Irongate with Link Road Stage 1+ Development Change in Traffic Volumes to 2021 Base	Figure 14
Gabites Porter Consultants		

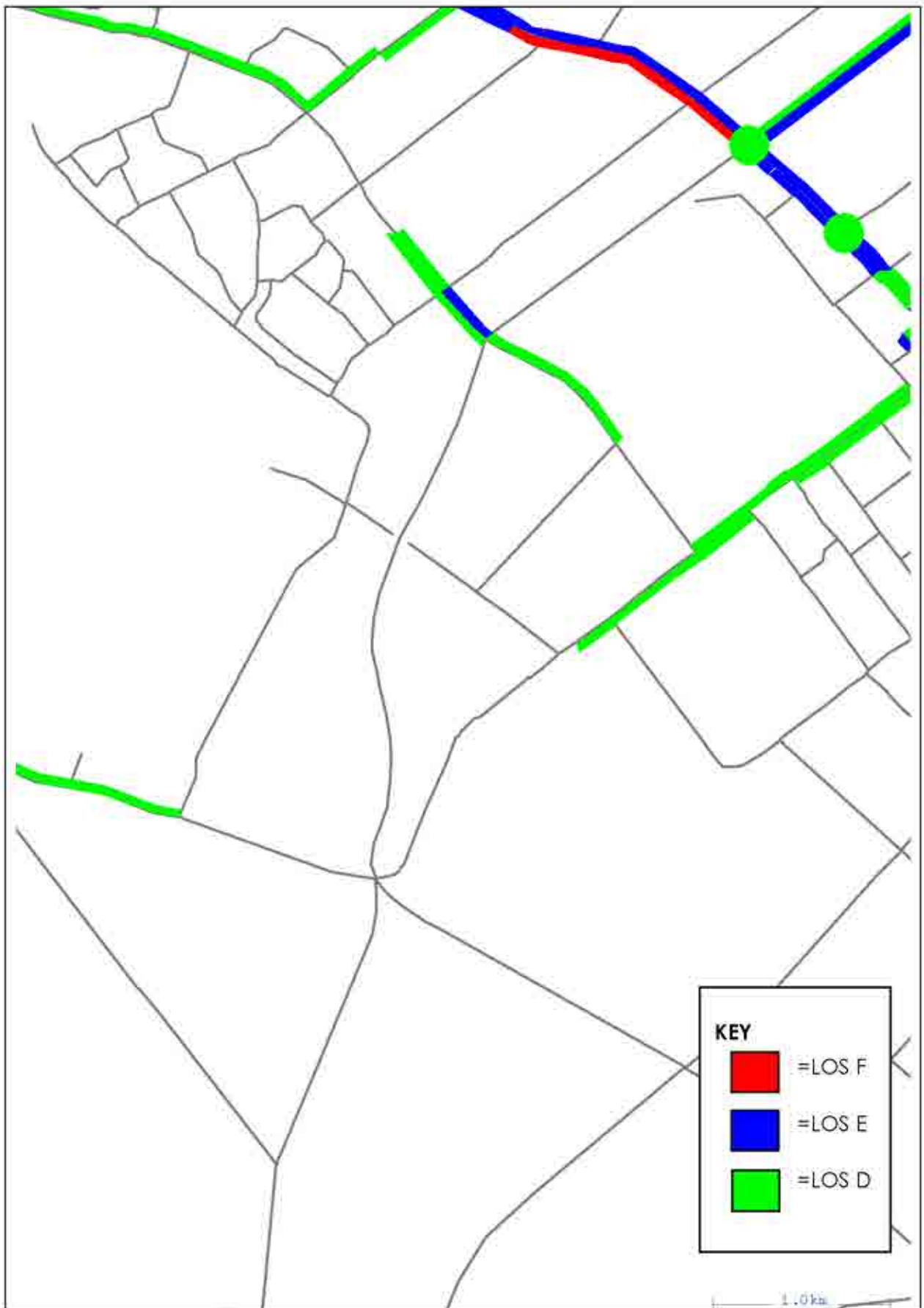

Hawke's Bay Irongate Modelling	2021 AM Peak Irongate with Link Road Stage 1+ Development Level of Service	Figure 16
Gabites Porter Consultants		

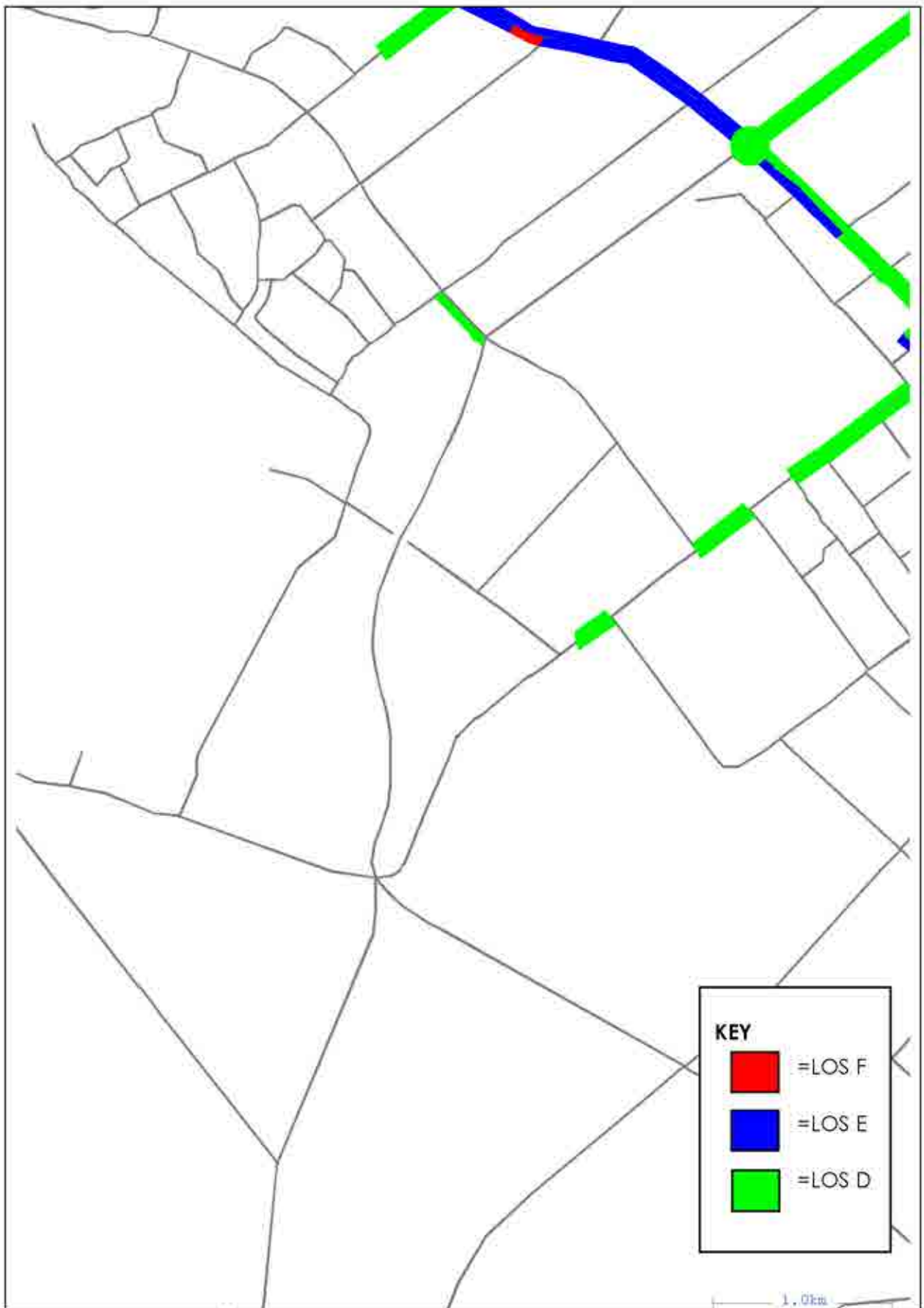

Hawke's Bay Irongate Modelling Gabites Porter Consultants	2021 SH Peak Irongate with Link Road Stage 1+ Development Level of Service	Figure 17
--	---	------------------

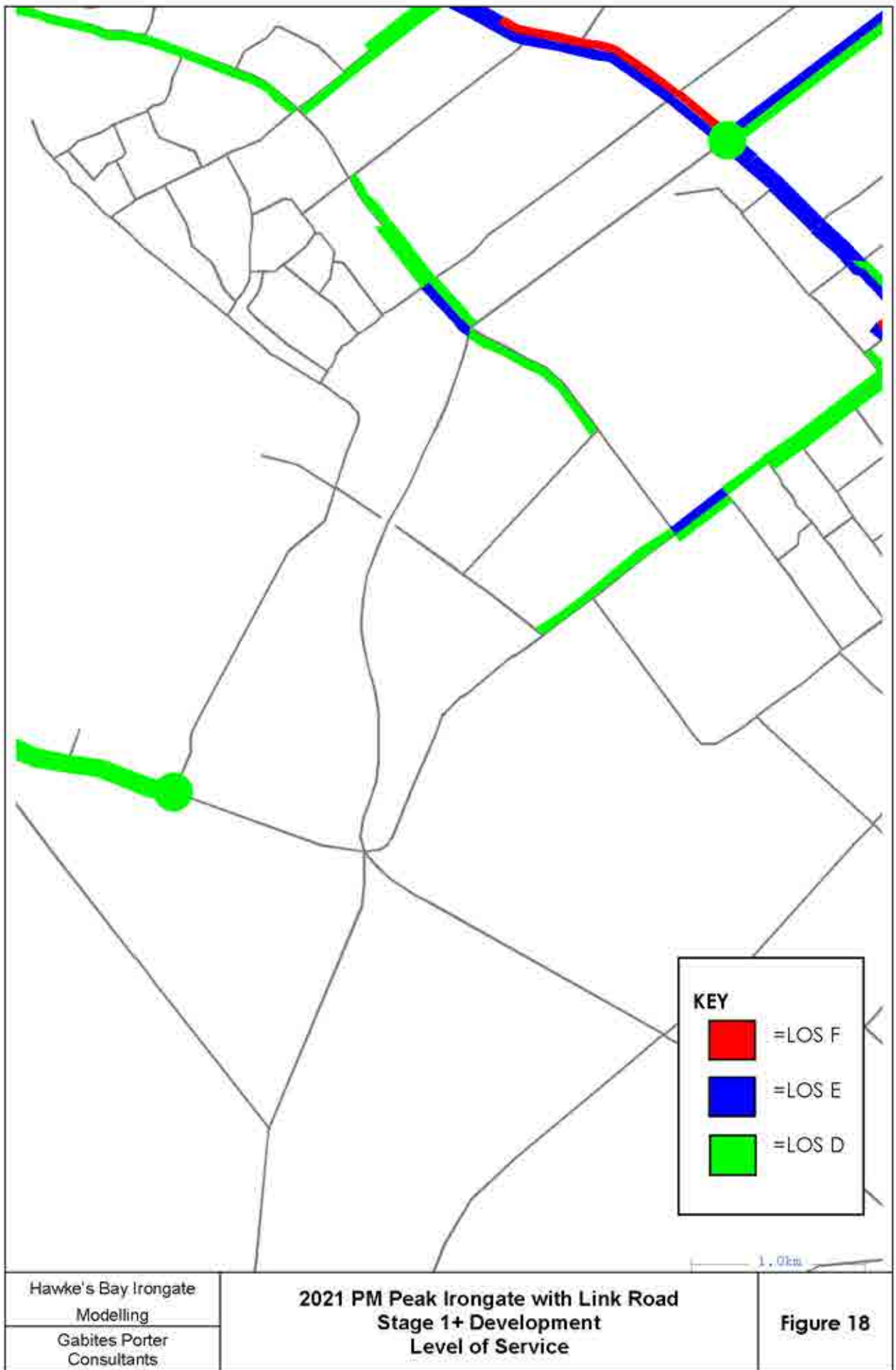

APPENDIX 6

2021 Stage 2:

- With Irongate development
- With Irongate + York Rd Link with Irongate Rd
- With Irongate + Left turn off expressway into Irongate Rd

1. 2021 AM Peak Irongate Stage 2 Development Traffic Volumes	1
2. 2021 SH Peak Irongate Stage 2 Development Traffic Volumes	2
3. 2021 PM Peak Irongate Stage 2 Development Traffic Volumes	3
4. 2021 AM Peak Irongate Stage 2 Development Change in Traffic Volumes to 2021 Base	4
5. 2021 SH Peak Irongate Stage 2 Development Change in Traffic Volumes to 2021 Base	5
6. 2021 PM Peak Irongate Stage 2 Development Change in Traffic Volumes to 2021 Base	6
7. 2021 AM Peak Irongate Stage 2 Development Level of Service	7
8. 2021 SH Peak Irongate Stage 2 Development Level of Service	8
9. 2021 PM Peak Irongate Stage 2 Development Level of Service	9
10. 2021 AM Peak Irongate with Link Road Stage 2 Development Traffic Volumes	10
11. 2021 SH Peak Irongate with Link Road Stage 2 Development Traffic Volumes	11
12. 2021 PM Peak Irongate with Link Road Stage 2 Development Traffic Volumes	12
13. 2021 AM Peak Irongate with Link Road Stage 2 Development Change in Traffic Volumes to 2021 Base	13
14. 2021 SH Peak Irongate with Link Road Stage 2 Development Change in Traffic Volumes to 2021 Base	14
15. 2021 PM Peak Irongate with Link Road Stage 2 Development Change in Traffic Volumes to 2021 Base	15
16. 2021 AM Peak Irongate with Link Road Stage 2 Development Level of Service	16
17. 2021 SH Peak Irongate with Link Road Stage 2 Development Level of Service	17
18. 2021 PM Peak Irongate with Link Road Stage 2 Development Level of Service	18

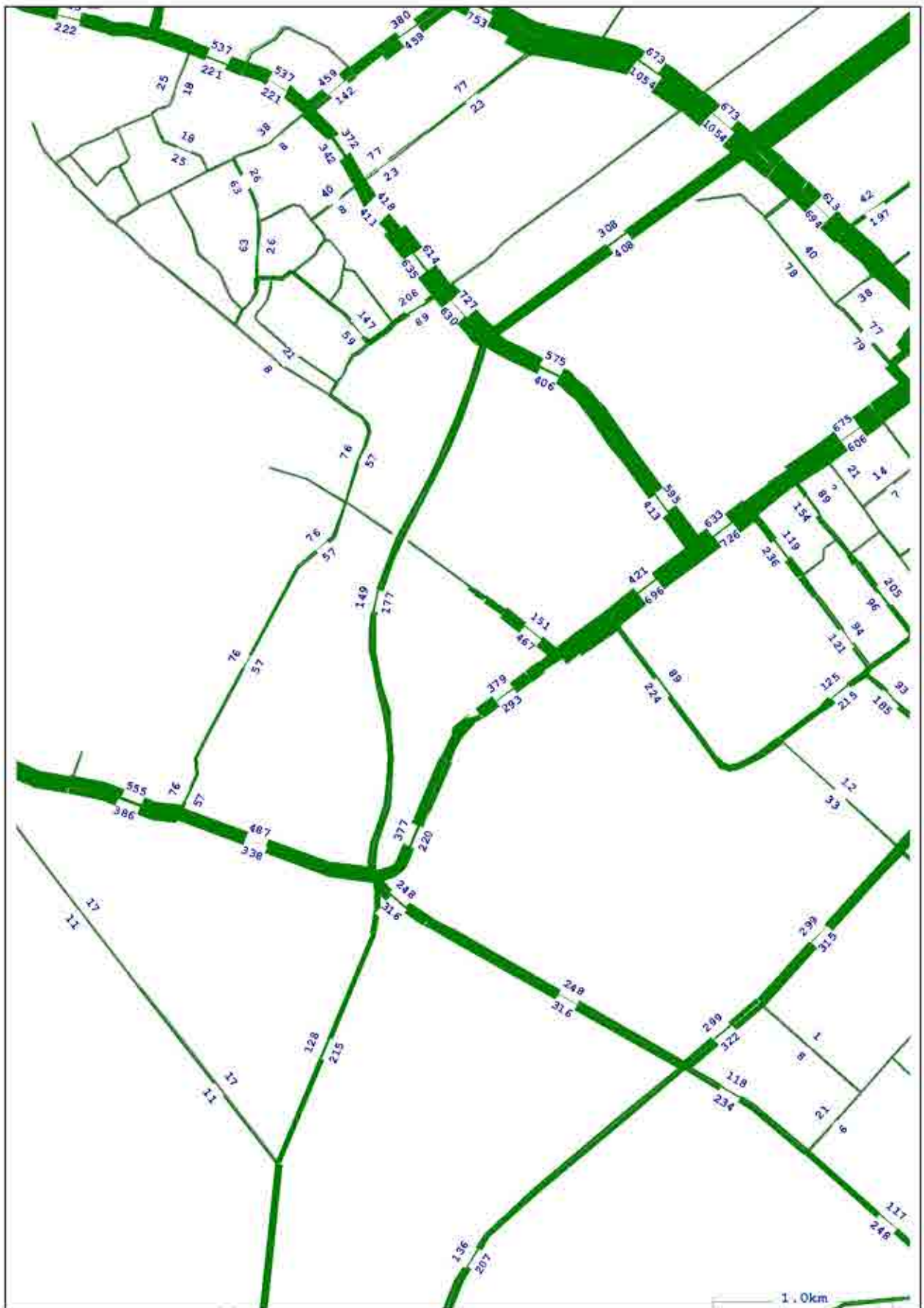

Hawke's Bay Irongate Modelling Gabites Porter Consultants	2021 AM Peak Irongate Stage 2 Development Traffic Volumes	Figure 1
--	--	-----------------

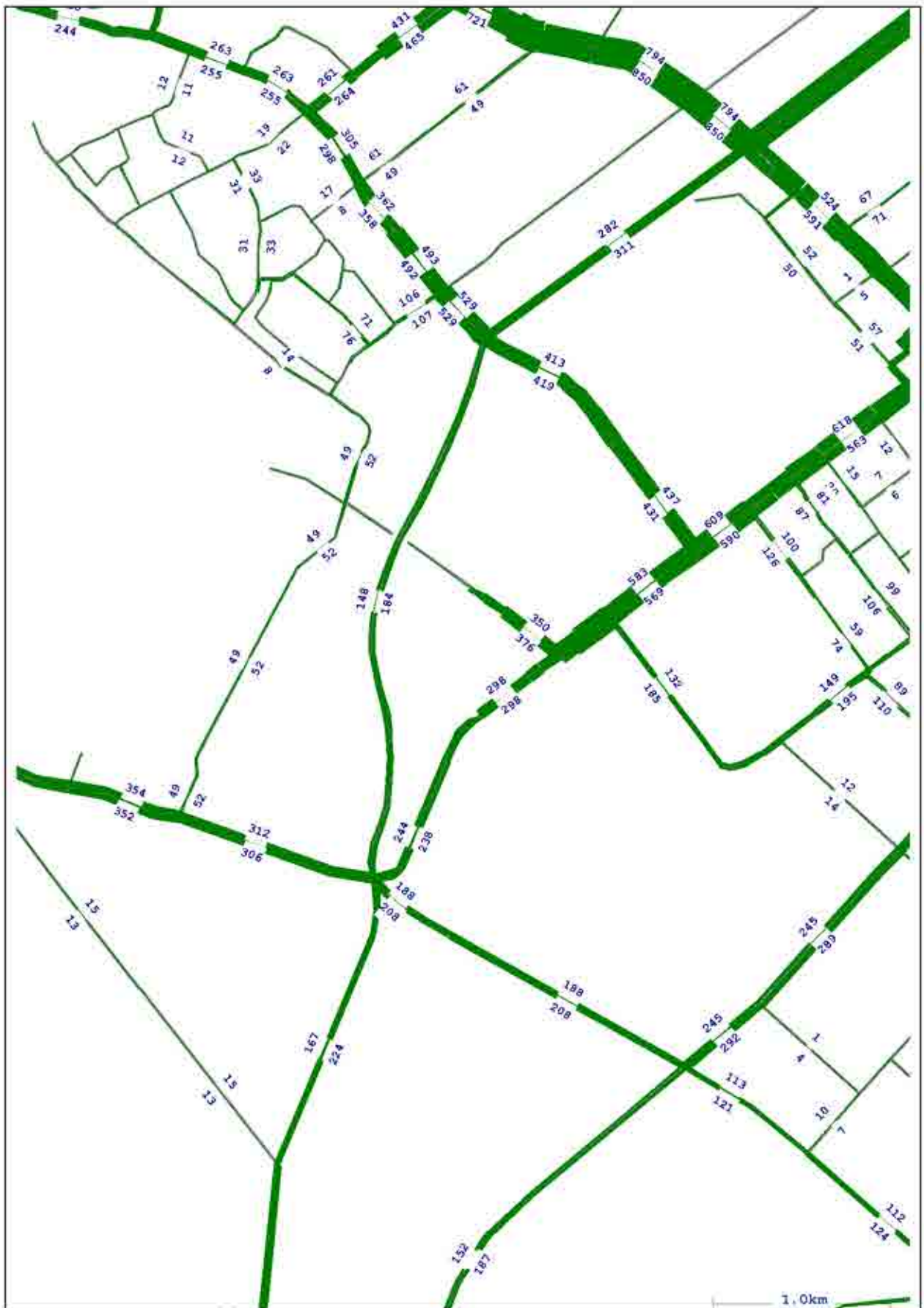

Hawke's Bay Irongate Modelling	2021 SH Peak Irongate Stage 2 Development Traffic Volumes	Figure 2
Gabites Porter Consultants		

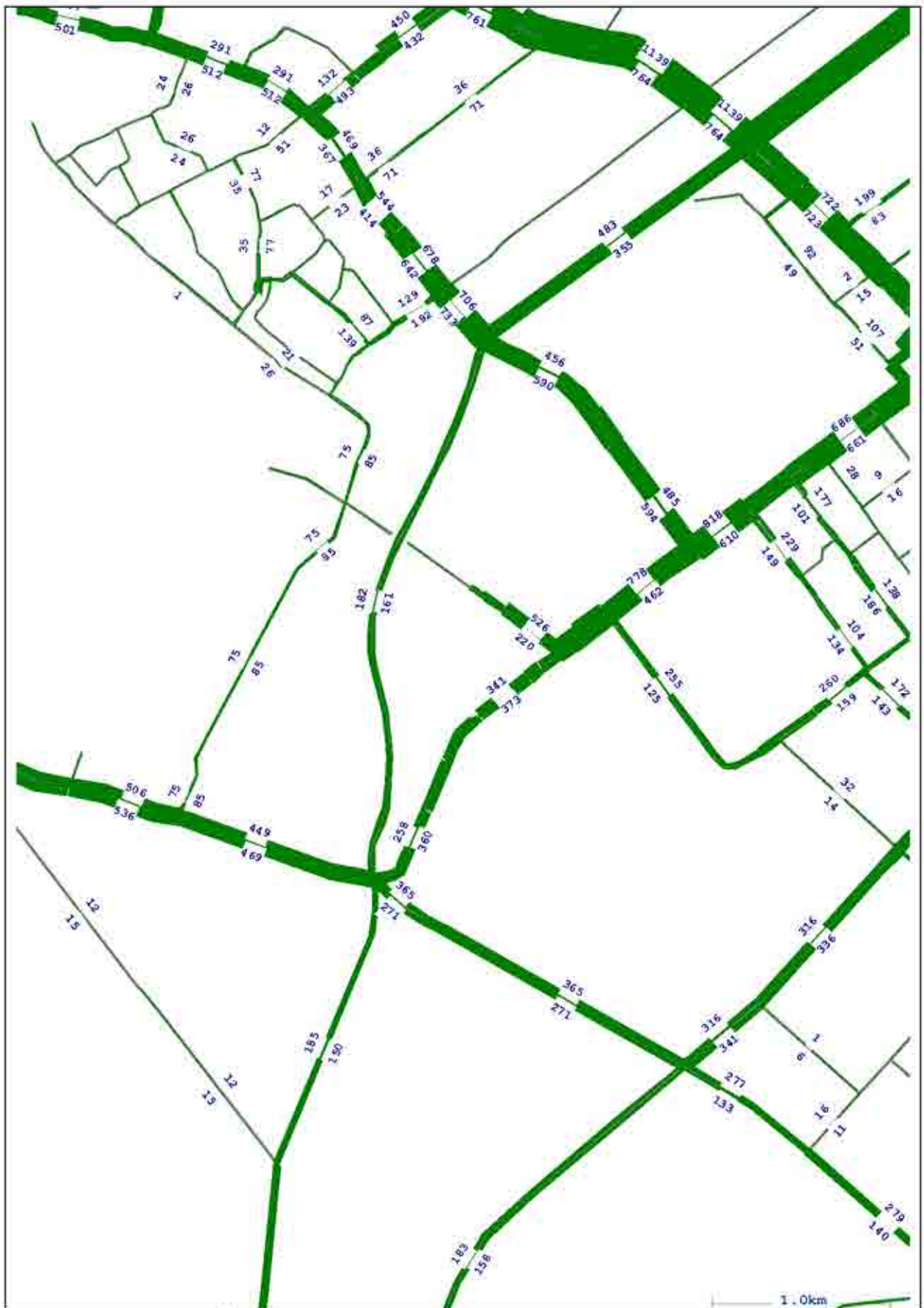

Hawke's Bay Irongate Modelling	2021 PM Peak Irongate Stage 2 Development Traffic Volumes	Figure 3
Gabites Porter Consultants		

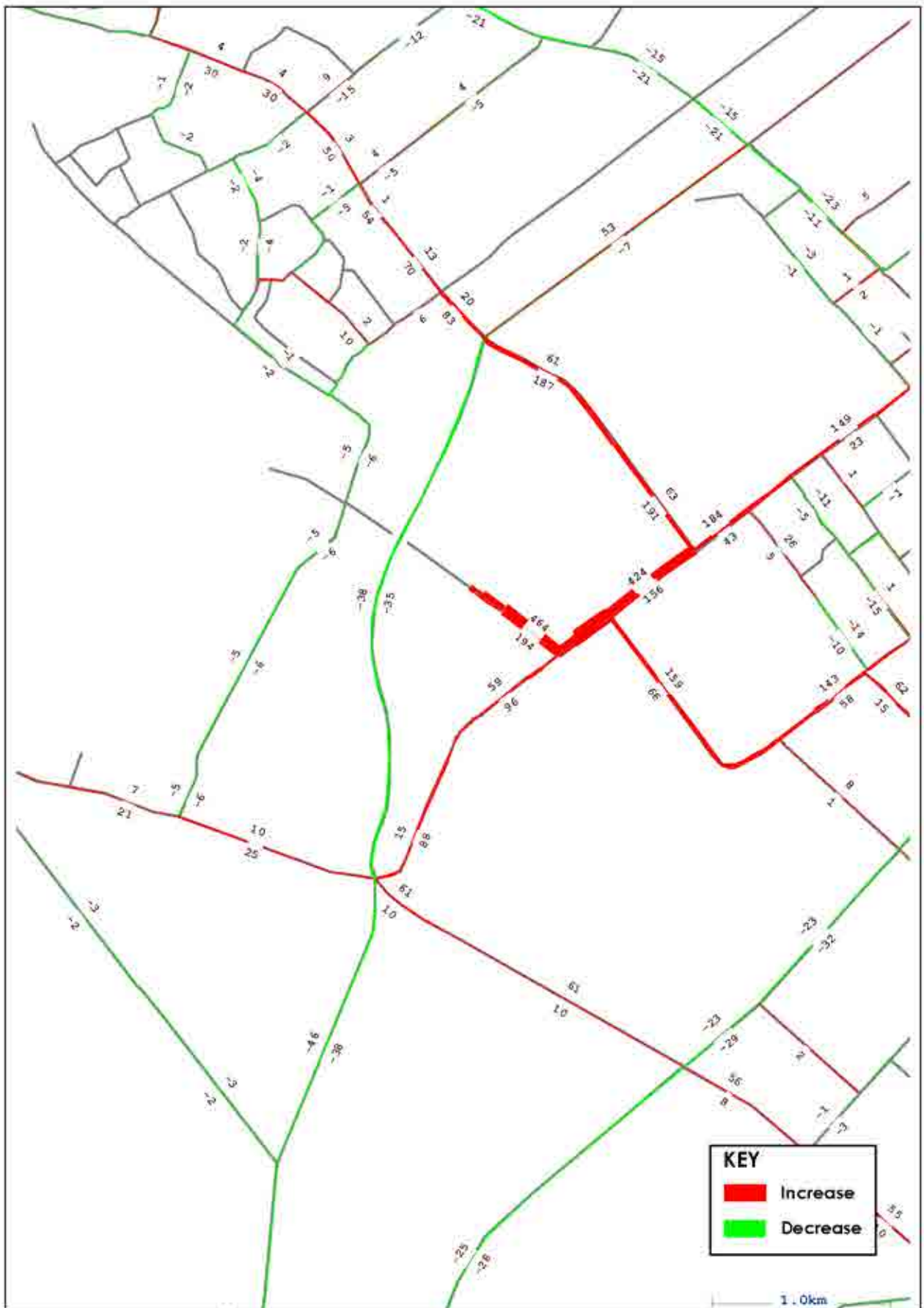

Hawke's Bay Irongate Modelling	2021 PM Peak Irongate Stage 2 Development Change in Traffic Volumes to 2021 Base	Figure 6
Gabites Porter Consultants		

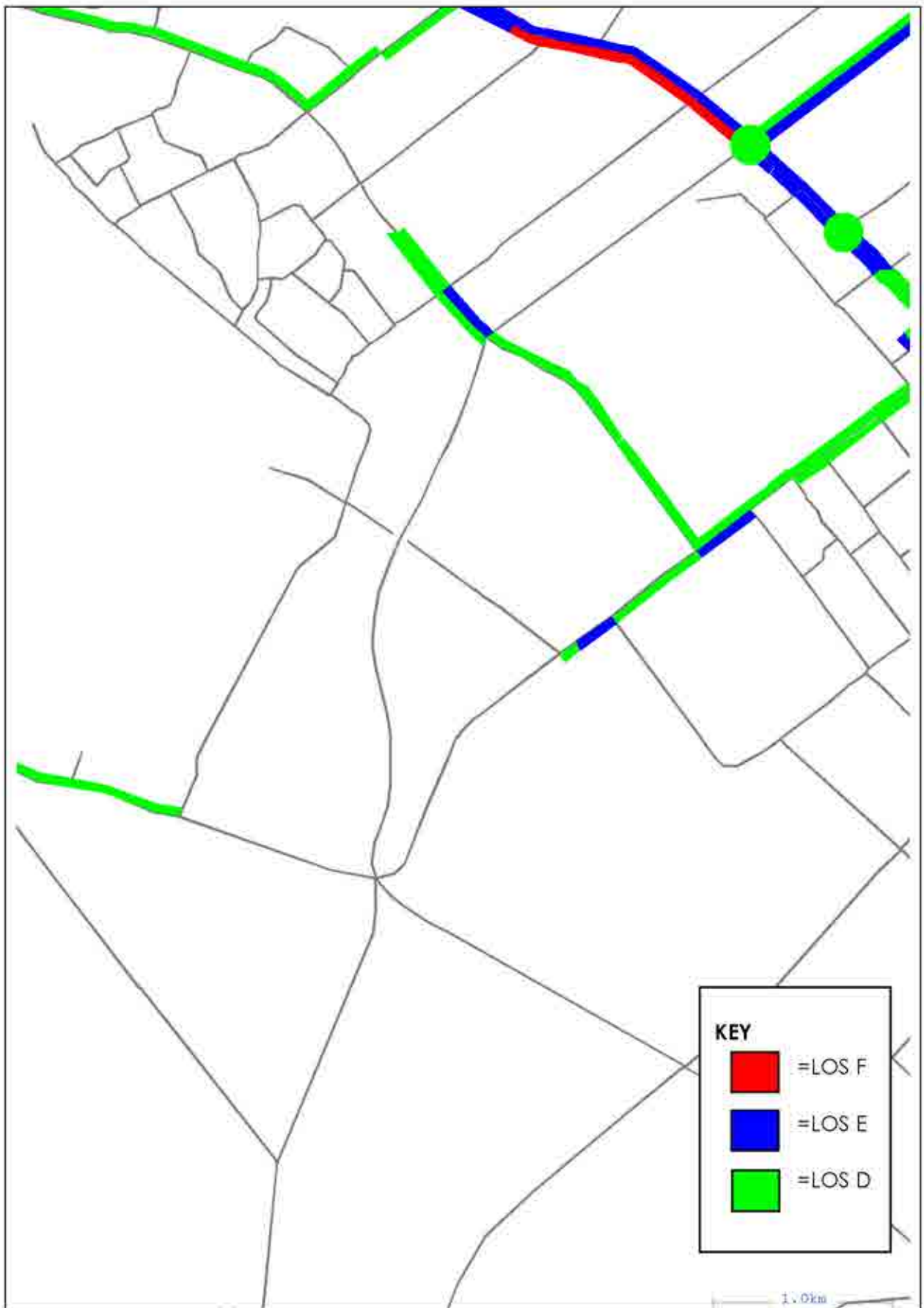

Hawke's Bay Irongate Modelling Gabites Porter Consultants	2021 AM Peak Irongate Stage 2 Development Level of Service	Figure 7
--	---	-----------------



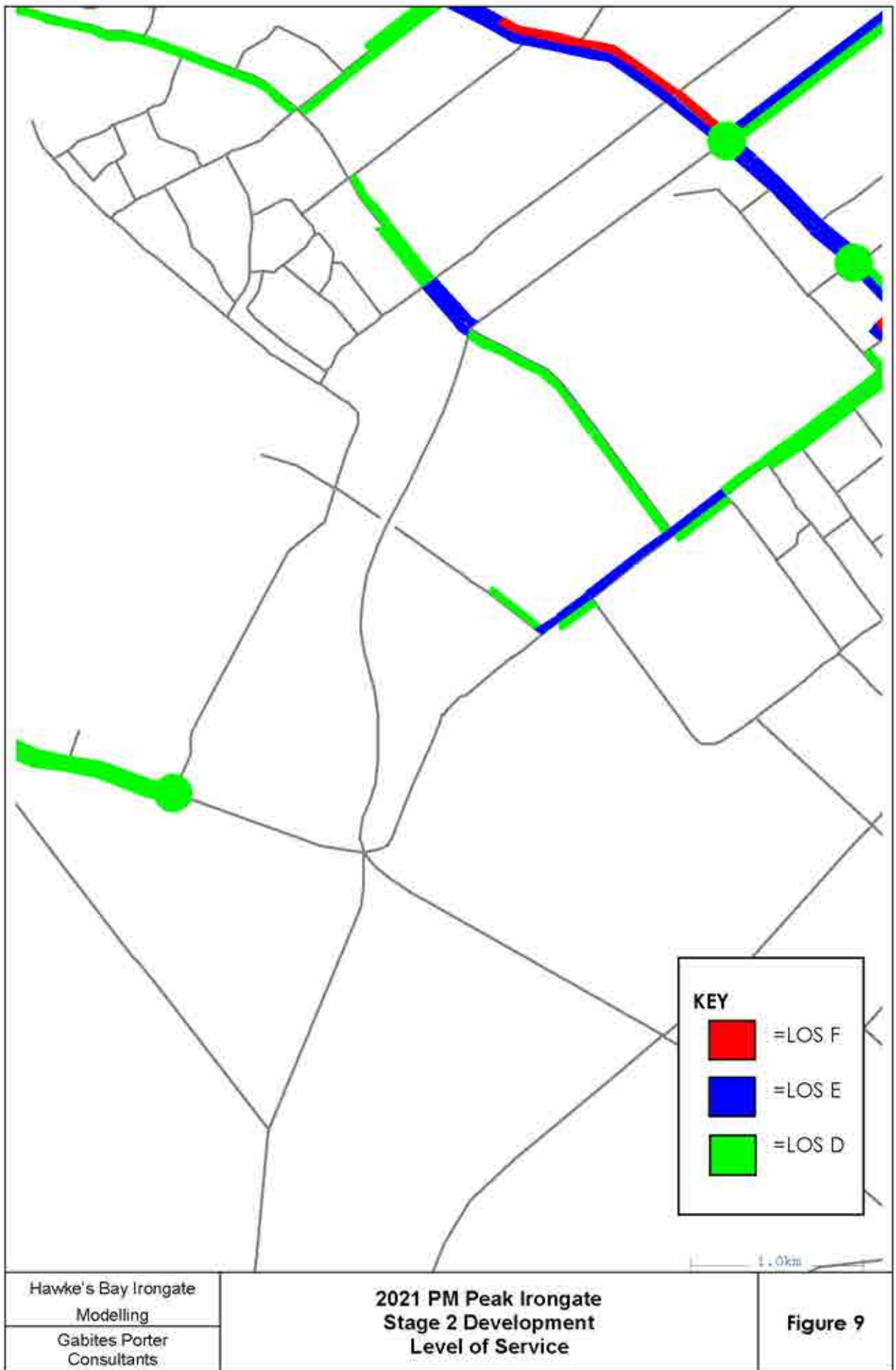

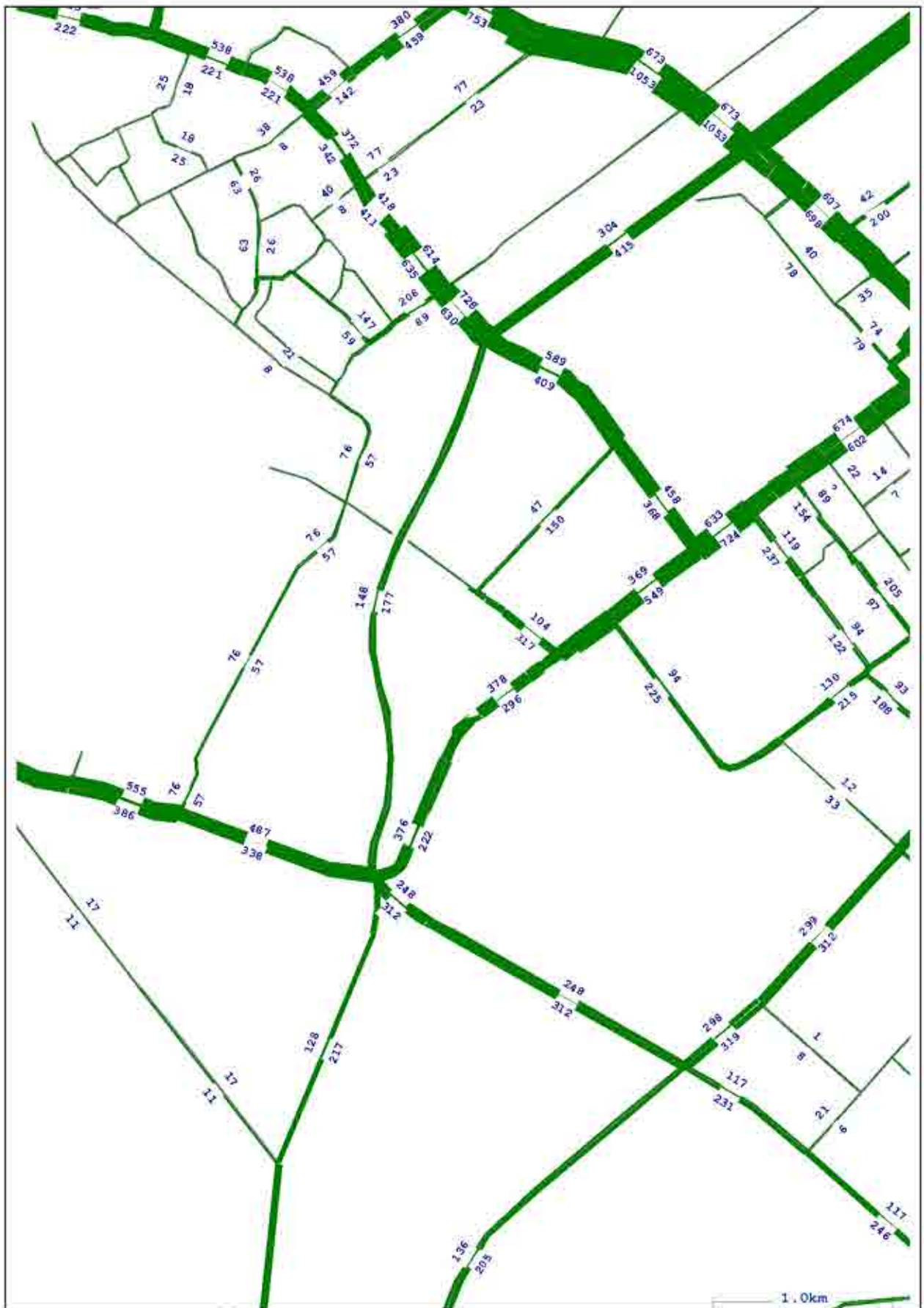

Hawke's Bay Irongate Modelling	2021 AM Peak Irongate with Link Road Stage 2 Development Traffic Volumes	Figure 10
Gabites Porter Consultants		

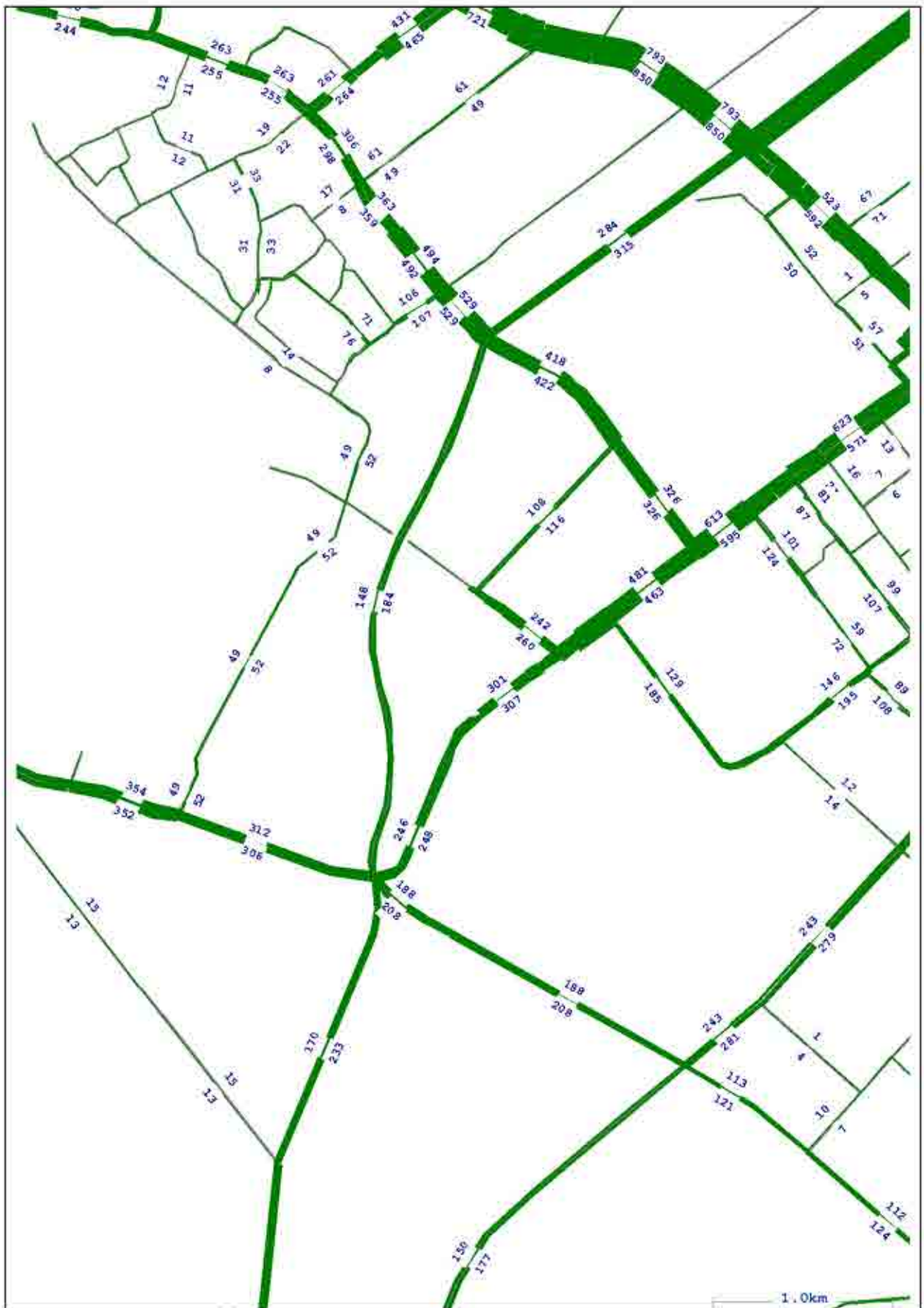

Hawke's Bay Irongate Modelling	2021 SH Peak Irongate with Link Road Stage 2 Development Traffic Volumes	Figure 11
Gabites Porter Consultants		

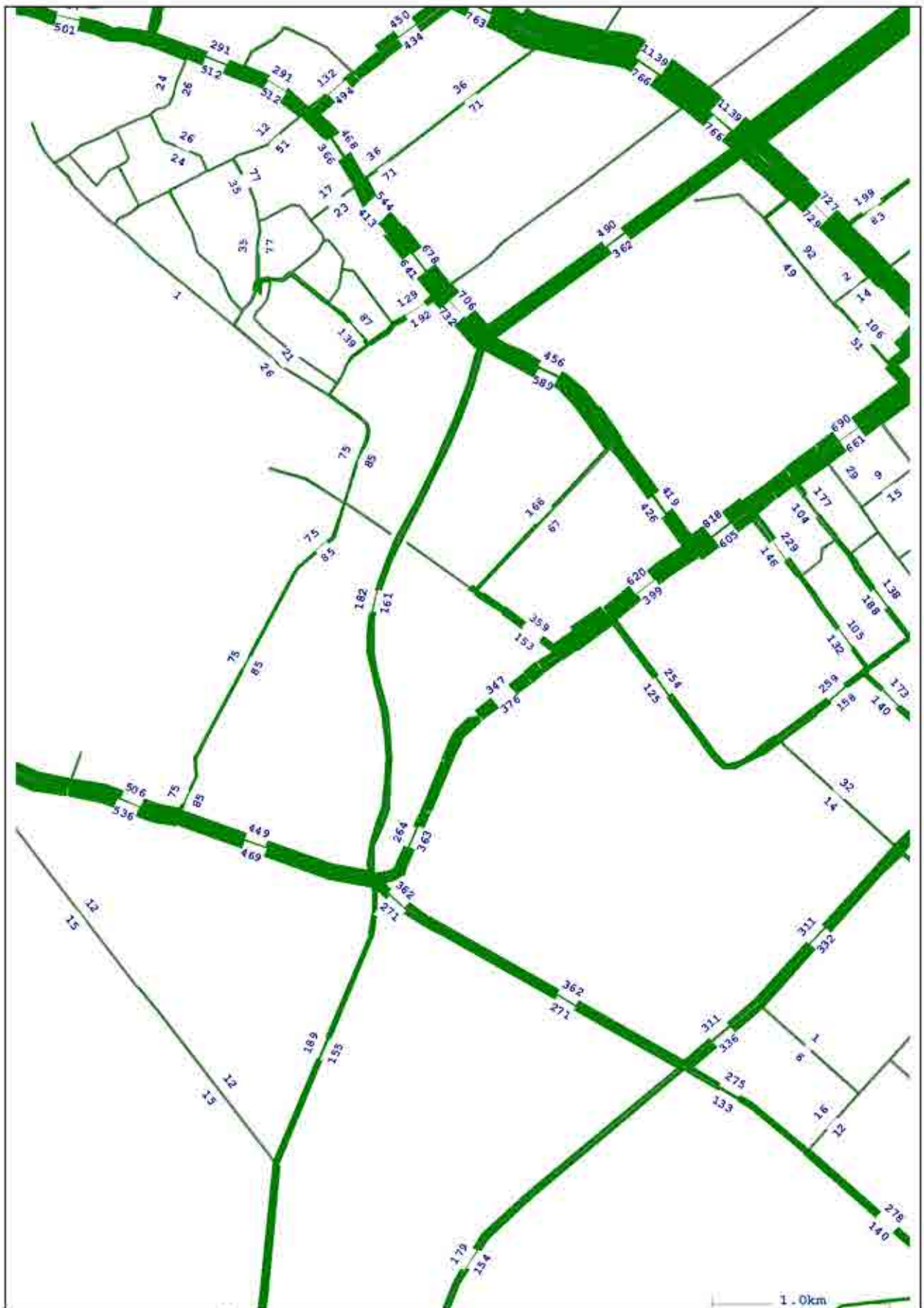

Hawke's Bay Irongate Modelling	2021 PM Peak Irongate with Link Road Stage 2 Development Traffic Volumes	Figure 12
Gabites Porter Consultants		

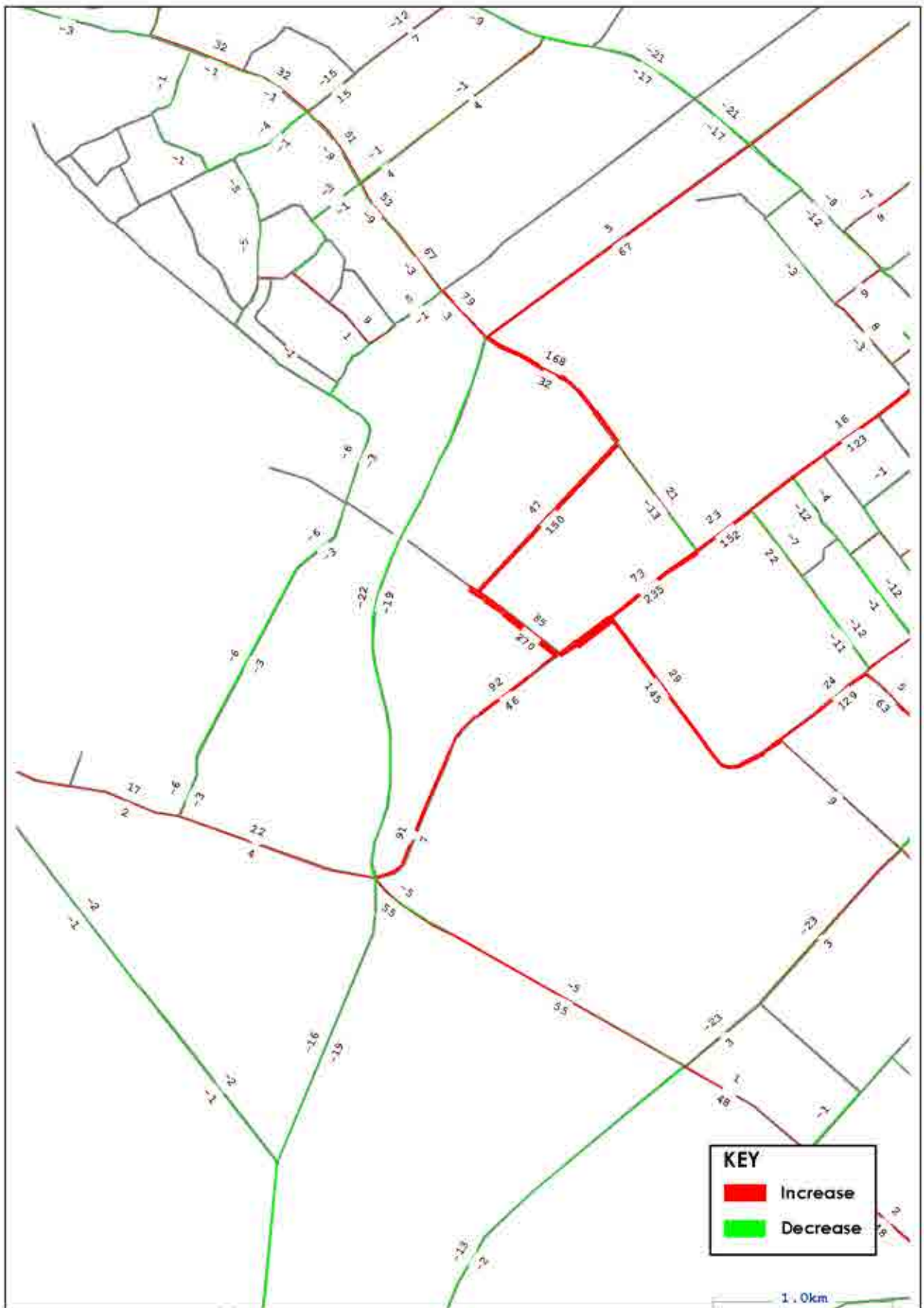

Hawke's Bay Irongate Modelling	2021 AM Peak Irongate with Link Road Stage 2 Development	Figure 13
Gabites Porter Consultants		

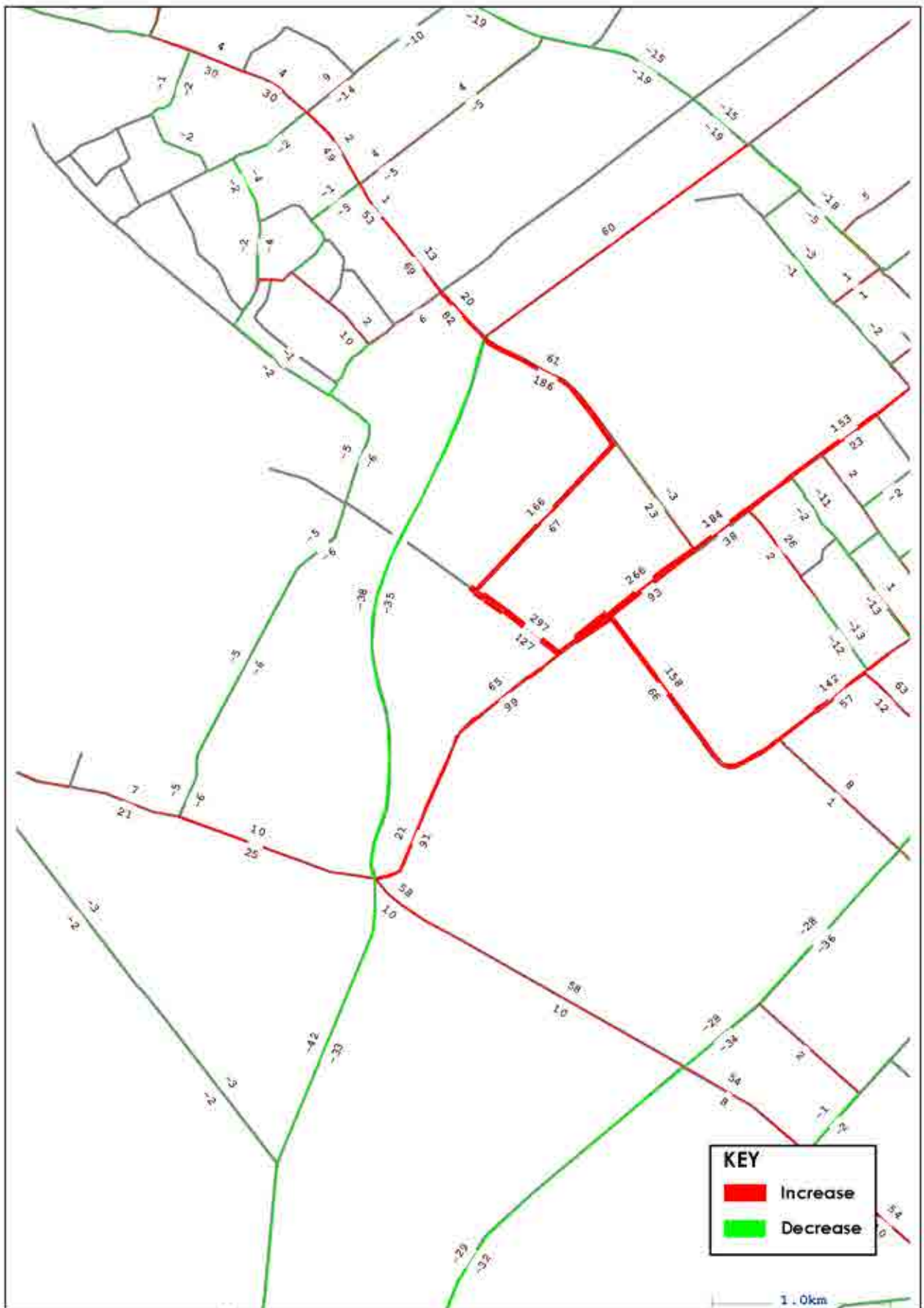

Hawke's Bay Irongate Modelling Gabites Porter Consultants	2021 PM Peak Irongate with Link Road Stage 2 Development Change in Traffic Volumes to 2021 Base	Figure 15
--	--	------------------

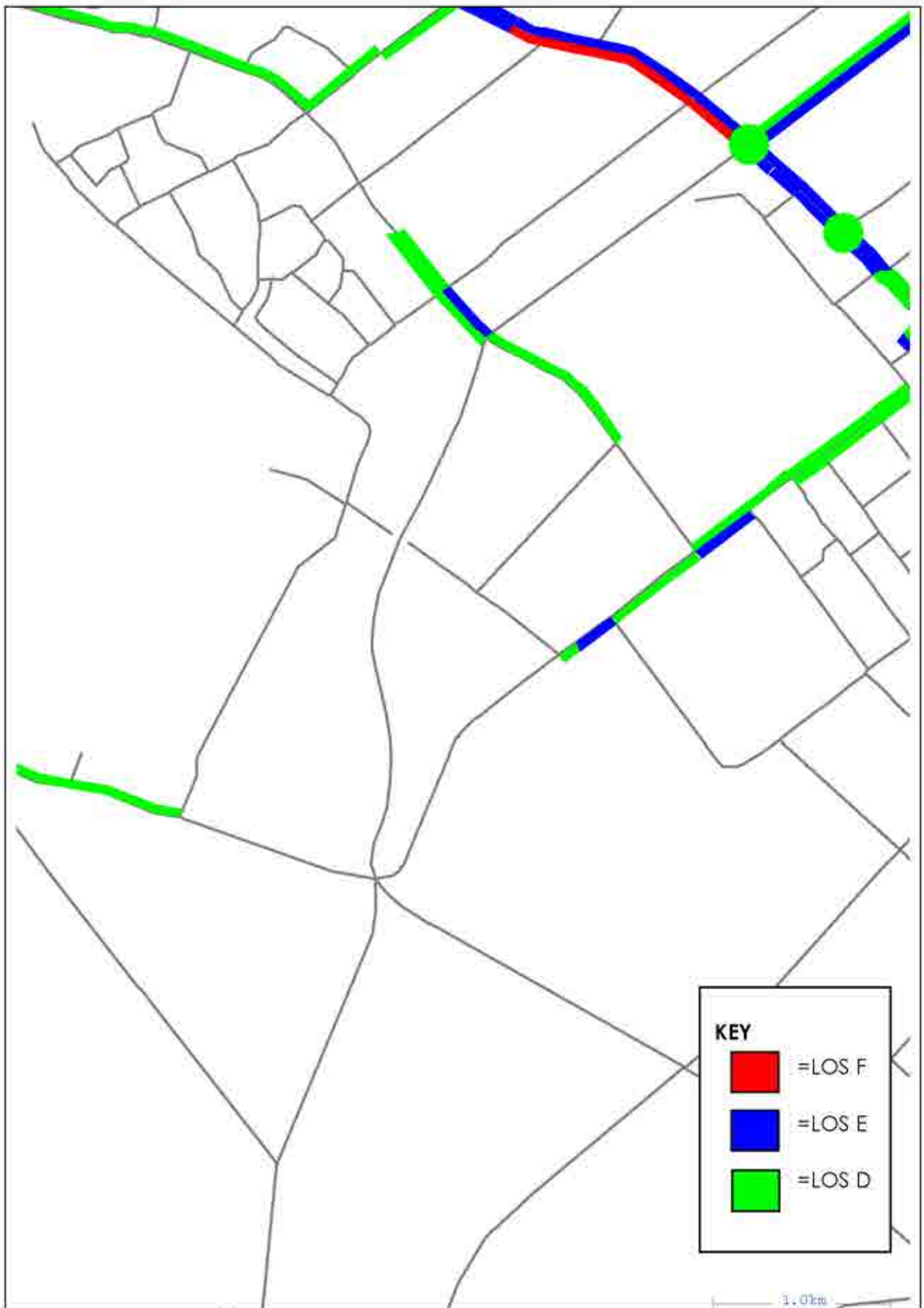

Hawke's Bay Irongate Modelling Gabites Porter Consultants	2021 AM Peak Irongate with Link Road Stage 2 Development Level of Service	Figure 16
--	--	------------------



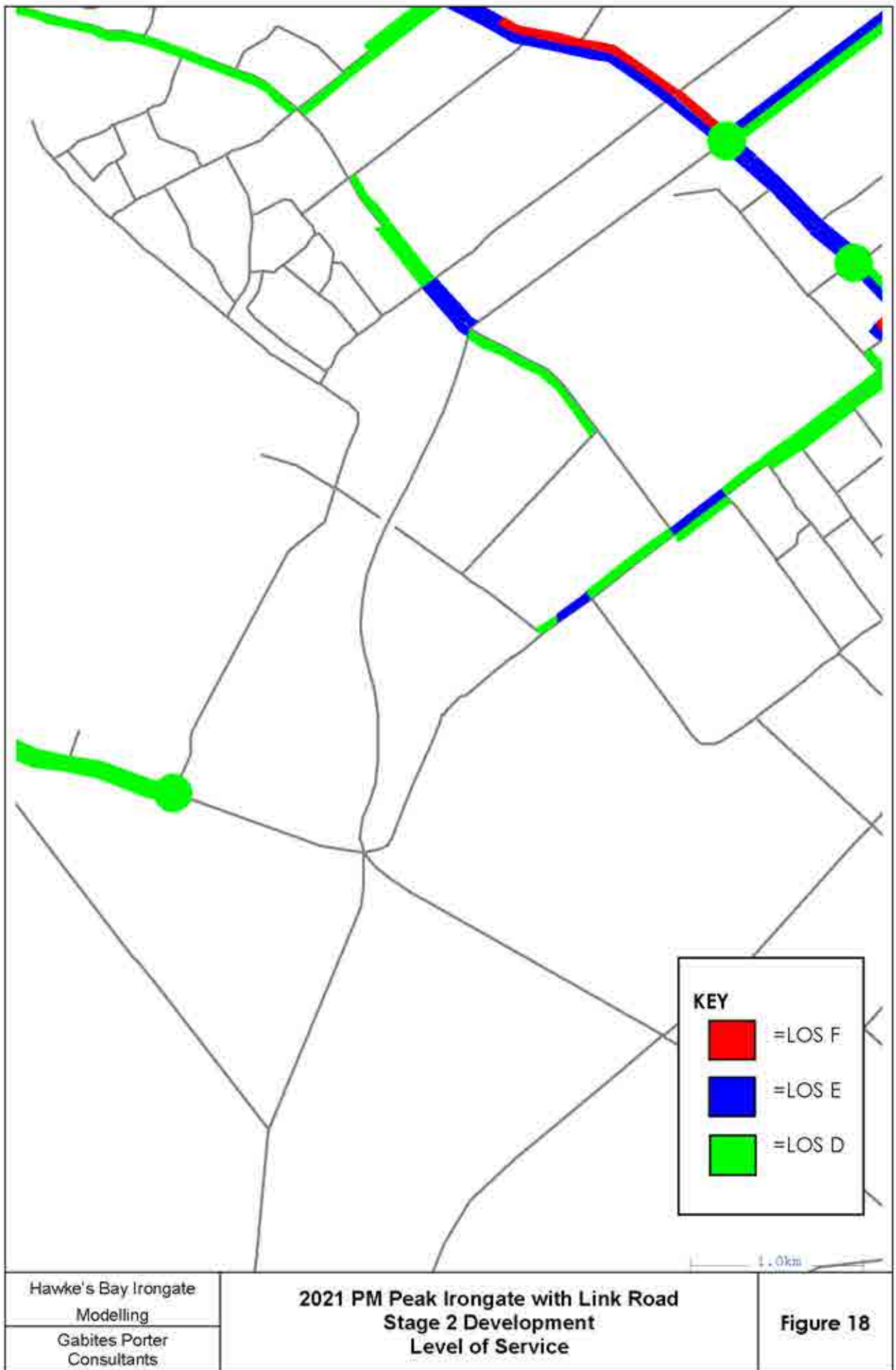

APPENDIX 7

2021 Stage 2+:

- With Irongate development
- With Irongate + York Rd Link with Irongate Rd
- With Irongate + Left turn off expressway into Irongate Rd

1. 2021 AM Peak Irongate Stage 2+ Development Traffic Volumes	1
2. 2021 SH Peak Irongate Stage 2+ Development Traffic Volumes	2
3. 2021 PM Peak Irongate Stage 2+ Development Traffic Volumes	3
4. 2021 AM Peak Irongate Stage 2+ Development Change in Traffic Volumes to 2021 Base	4
5. 2021 SH Peak Irongate Stage 2+ Development Change in Traffic Volumes to 2021 Base	5
6. 2021 PM Peak Irongate Stage 2+ Development Change in Traffic Volumes to 2021 Base	6
7. 2021 AM Peak Irongate Stage 2+ Development Level of Service	7
8. 2021 SH Peak Irongate Stage 2+ Development Level of Service	8
9. 2021 PM Peak Irongate Stage 2+ Development Level of Service	9
10. 2021 AM Peak Irongate with Link Road Stage 2+ Development Traffic Volumes	10
11. 2021 SH Peak Irongate with Link Road Stage 2+ Development Traffic Volumes	11
12. 2021 PM Peak Irongate with Link Road Stage 2+ Development Traffic Volumes	12
13. 2021 AM Peak Irongate with Link Road Stage 2+ Development Change in Traffic Volumes to 2021 Base	13
14. 2021 SH Peak Irongate with Link Road Stage 2+ Development Change in Traffic Volumes to 2021 Base	14
15. 2021 PM Peak Irongate with Link Road Stage 2+ Development Change in Traffic Volumes to 2021 Base	15
16. 2021 AM Peak Irongate with Link Road Stage 2+ Development Level of Service	16
17. 2021 SH Peak Irongate with Link Road Stage 2+ Development Level of Service	17
18. 2021 PM Peak Irongate with Link Road Stage 2+ Development Level of Service	18

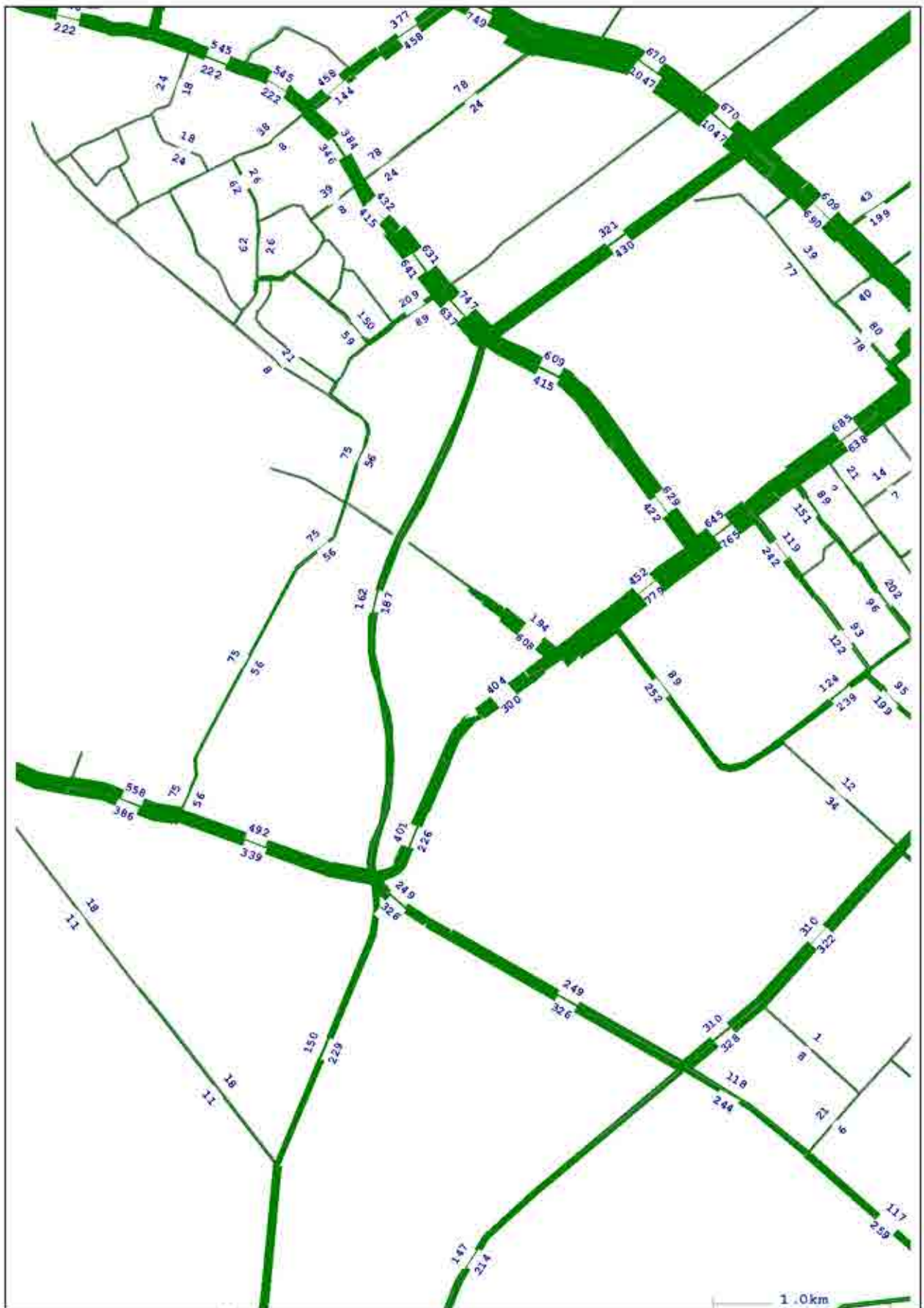

Hawke's Bay Irongate Modelling	2021 AM Peak Irongate Stage 2+ Development Traffic Volumes	Figure 1
Gabites Porter Consultants		

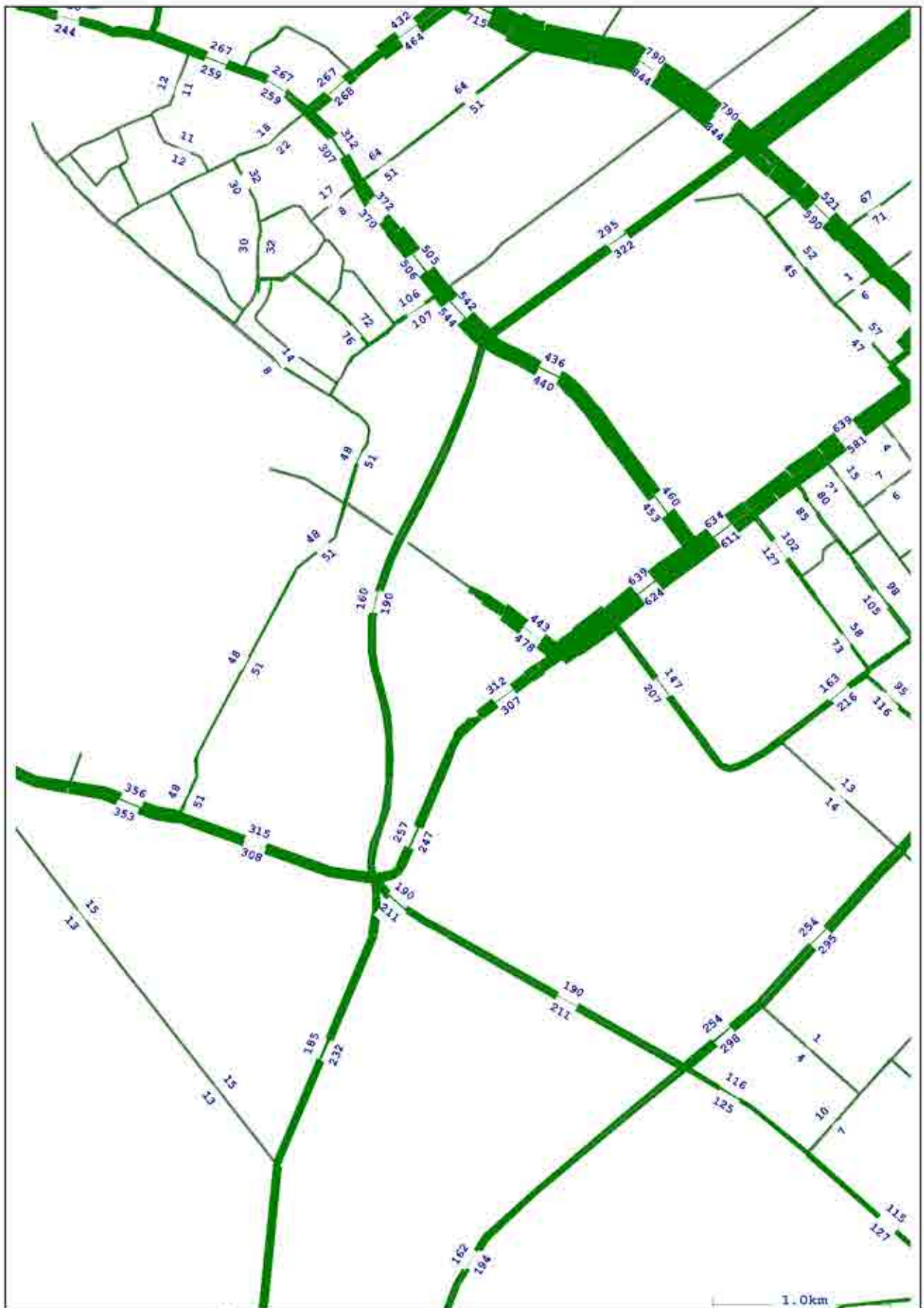

Hawke's Bay Irongate Modelling	2021 SH Peak Irongate Stage 2+ Development Traffic Volumes	Figure 2
Gabites Porter Consultants		

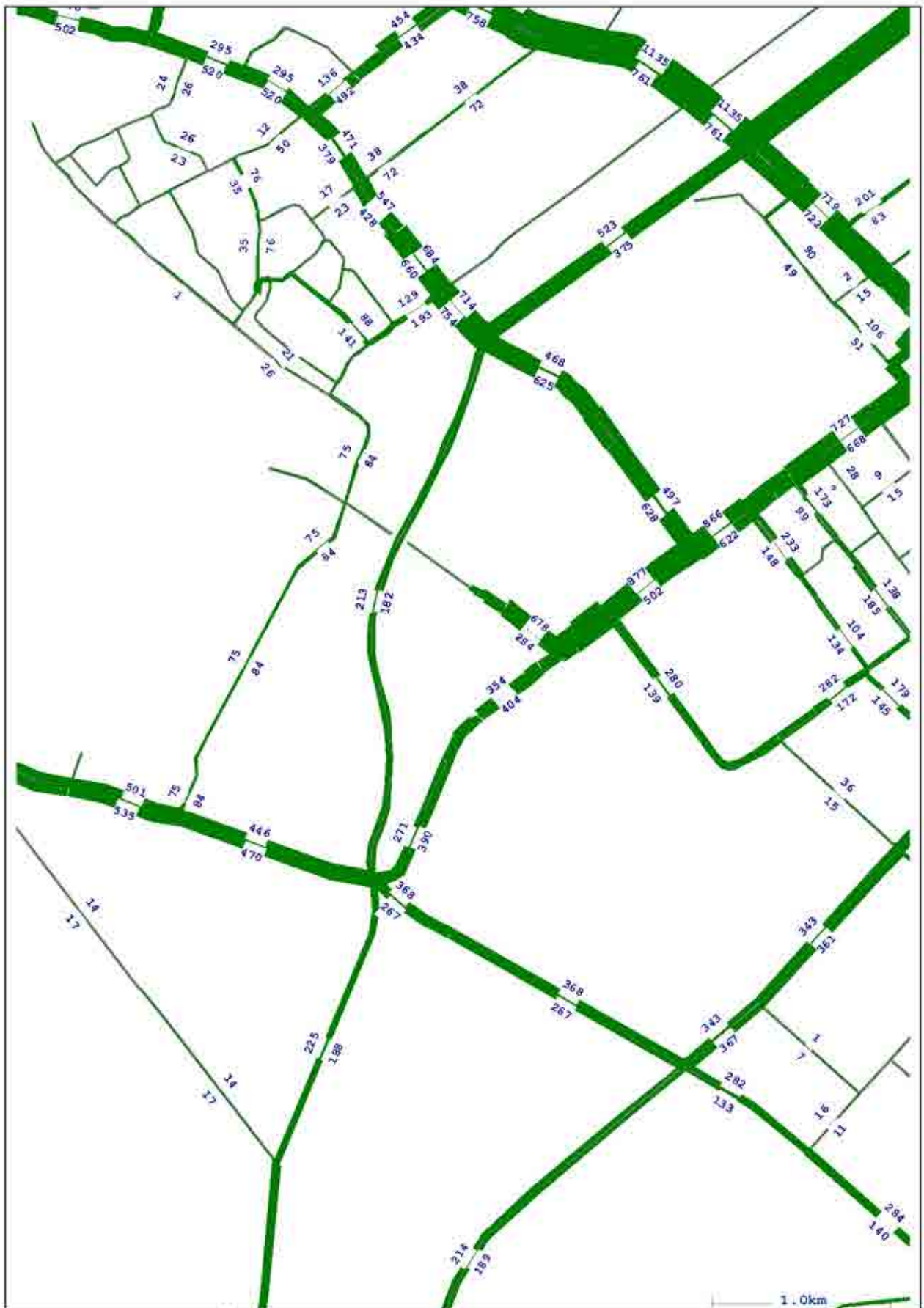

Hawke's Bay Irongate Modelling	2021 PM Peak Irongate Stage 2+ Development Traffic Volumes	Figure 3
Gabites Porter Consultants		

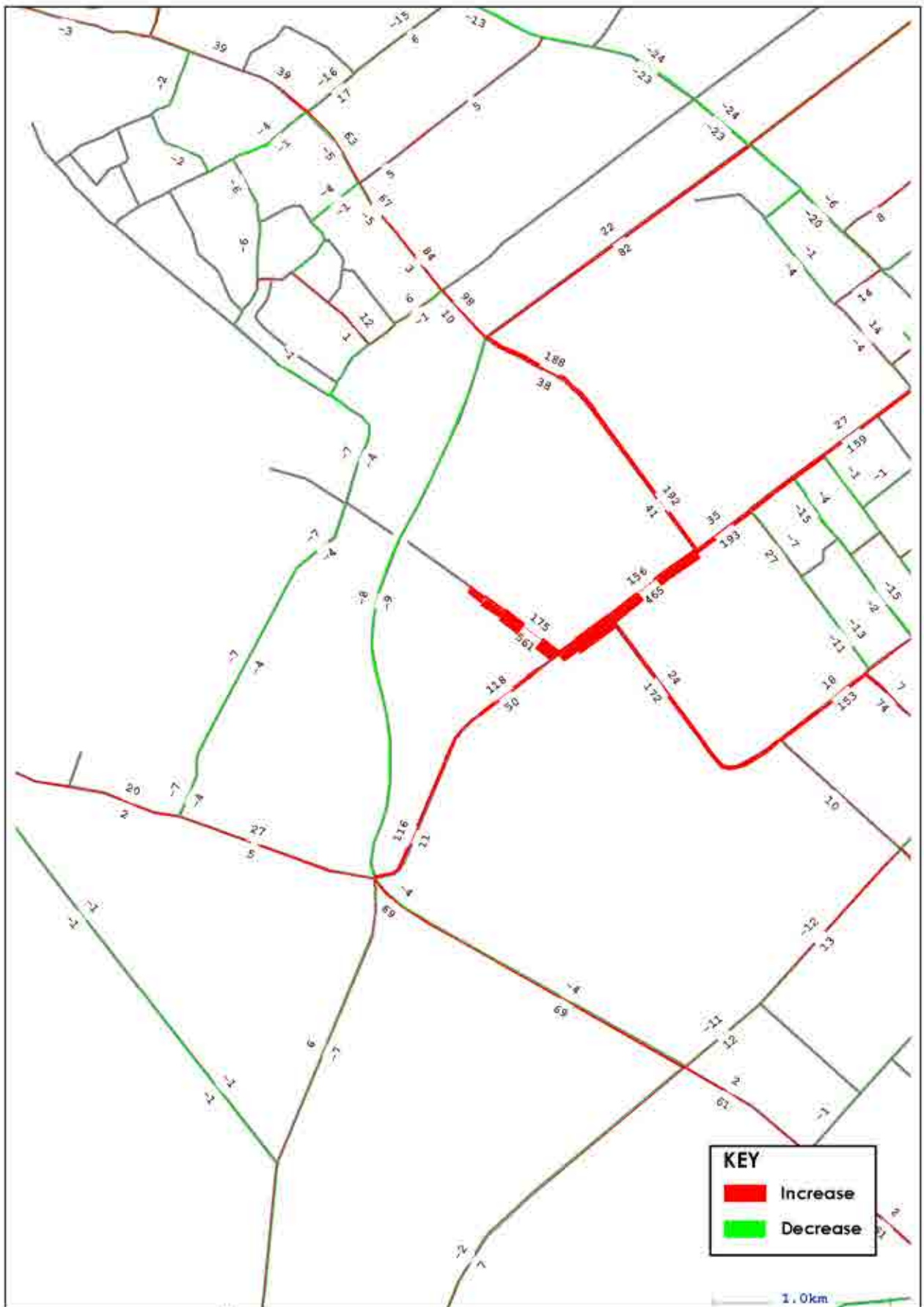

Hawke's Bay Irongate Modelling	2021 AM Peak Irongate Stage 2+ Development	Figure 4
Gabites Porter Consultants		

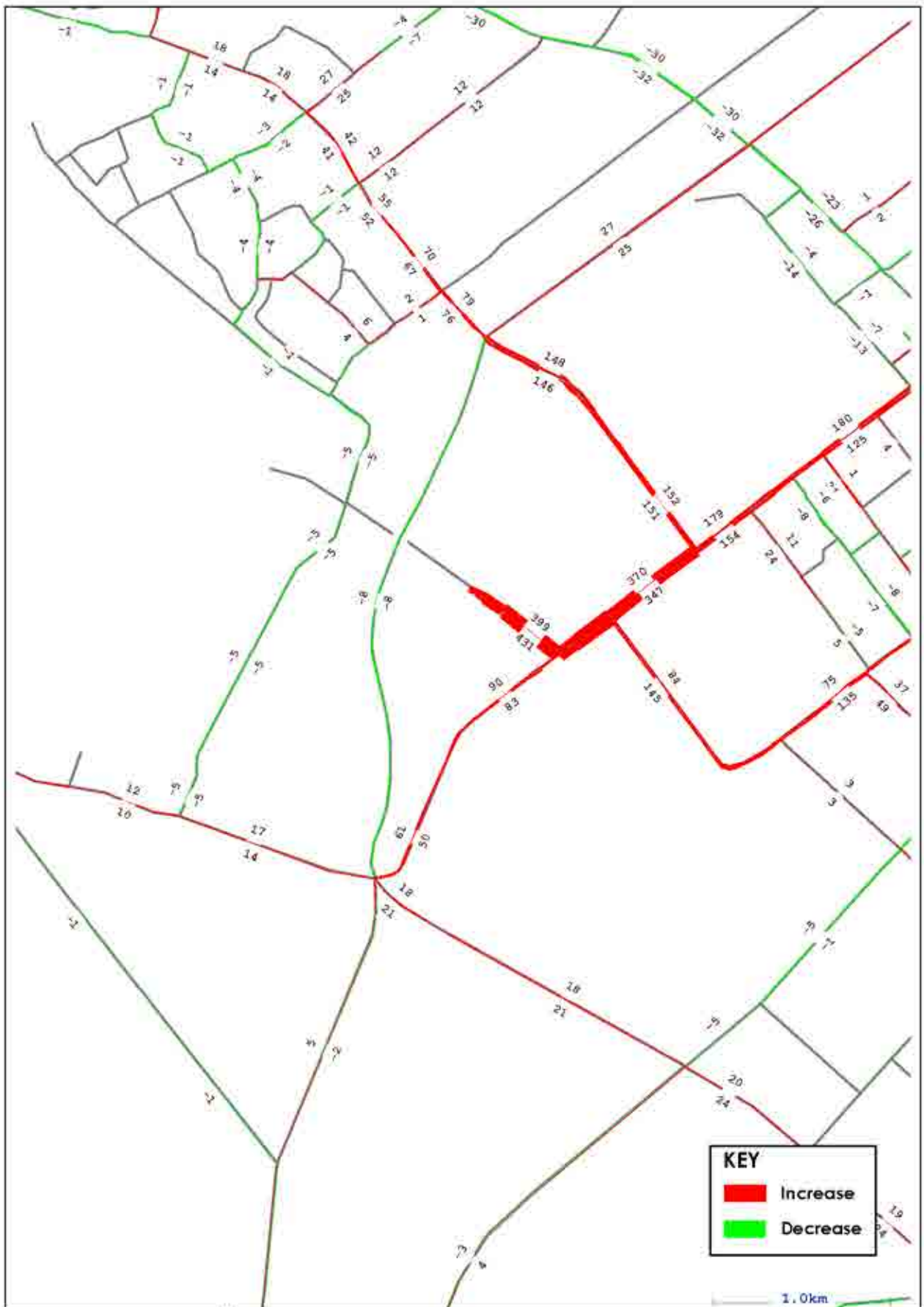

Hawke's Bay Irongate Modelling Gabites Porter Consultants	2021 SH Peak Irongate Stage 2+ Development Change in Traffic Volumes to 2021 Base	Figure 5
--	--	-----------------

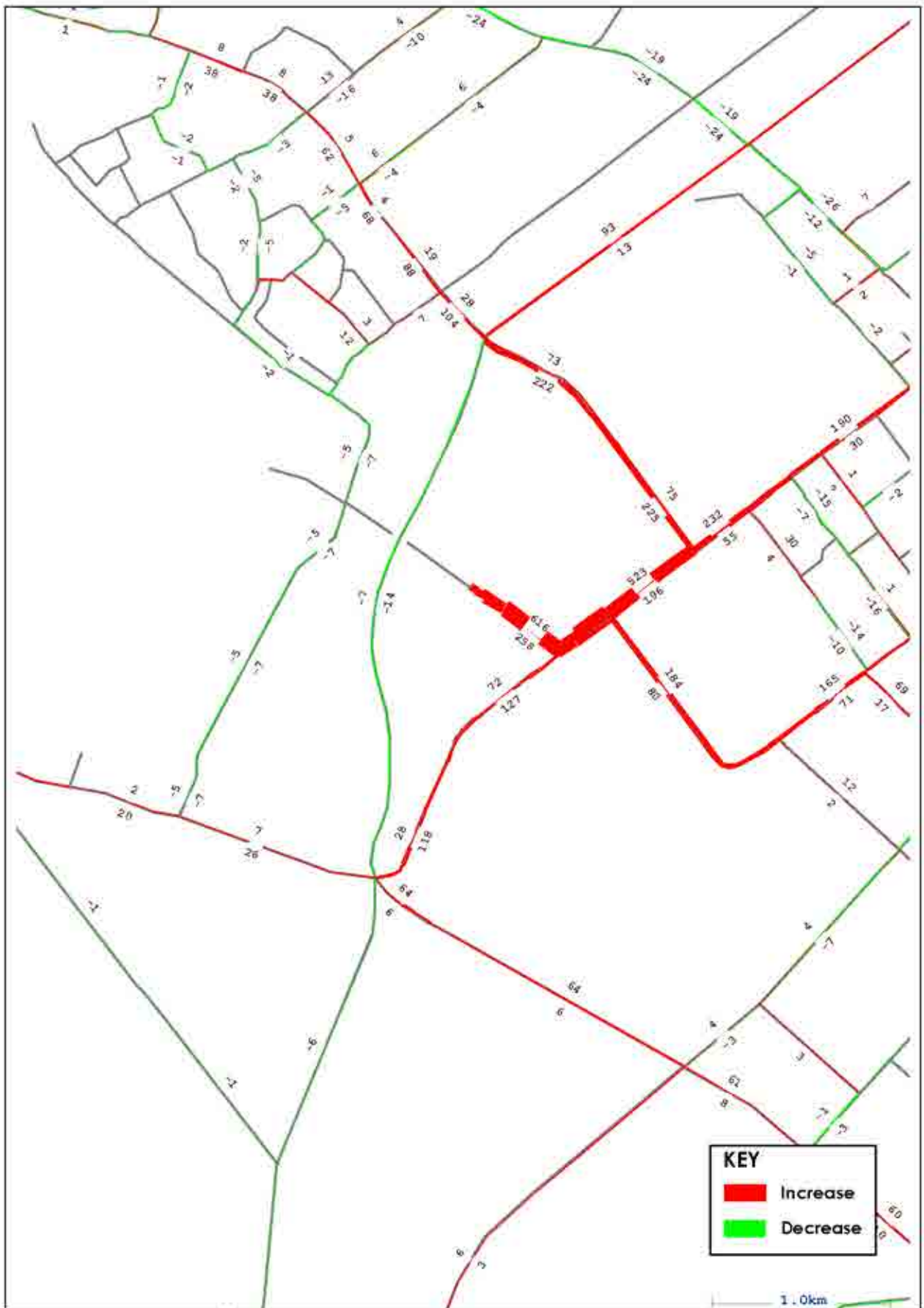

Hawke's Bay Irongate Modelling Gabites Porter Consultants	2021 PM Peak Irongate Stage 2+ Development Change in Traffic Volumes to 2021 Base	Figure 6
--	--	-----------------

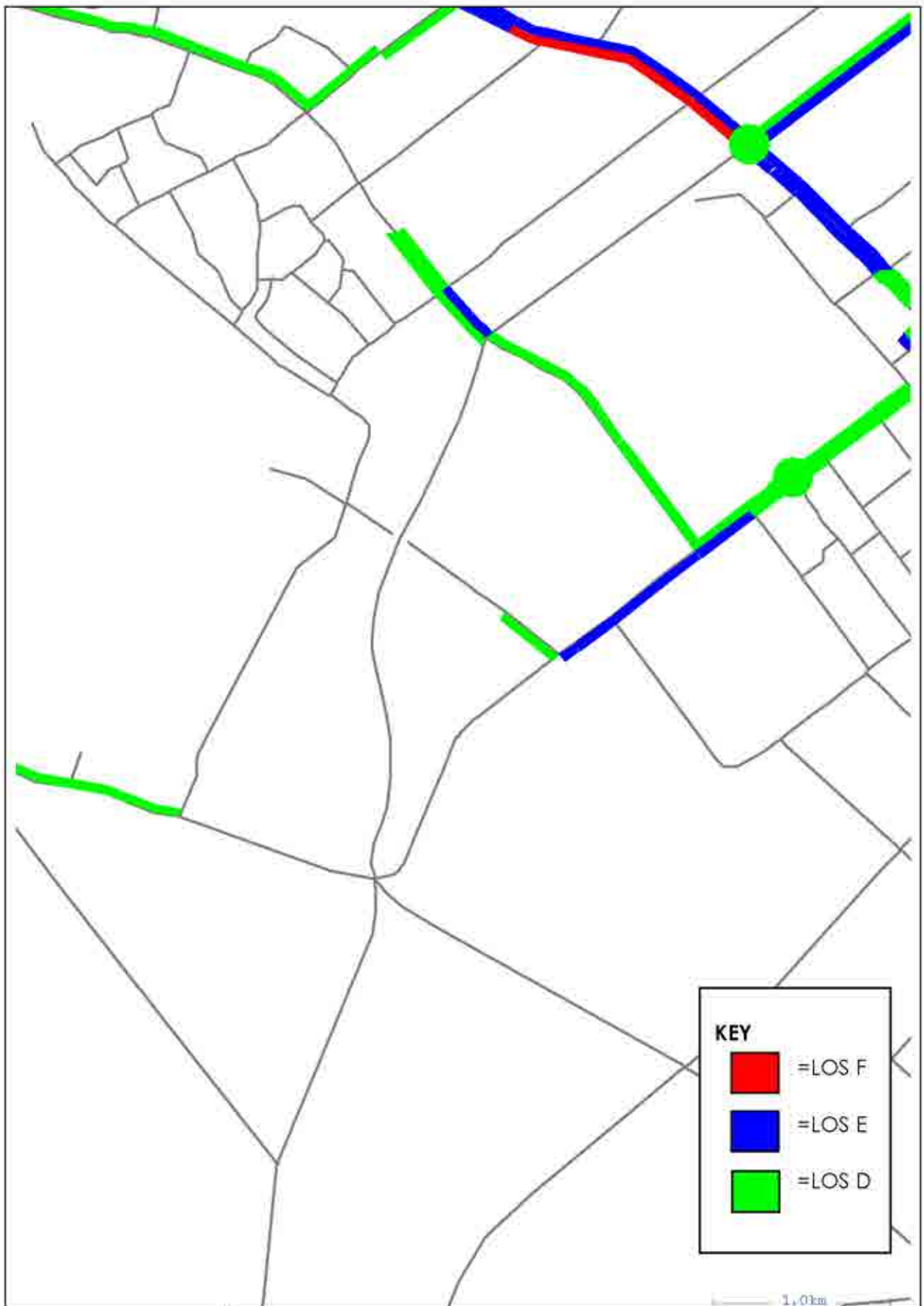

Hawke's Bay Irongate Modelling Gabites Porter Consultants	2021 AM Peak Irongate Stage 2+ Development Level of Service	Figure 7
--	--	-----------------

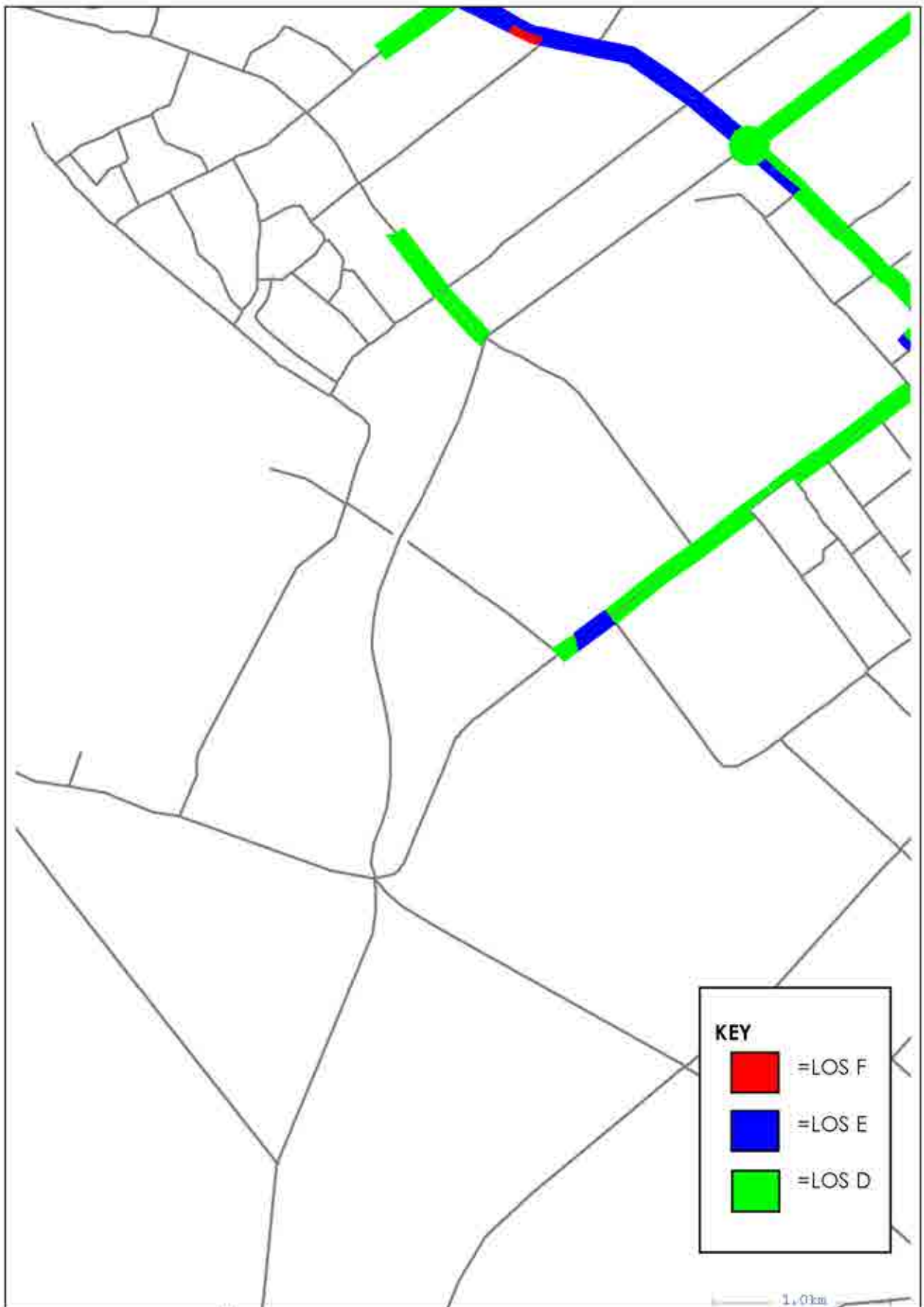

Hawke's Bay Irongate Modelling Gabites Porter Consultants	2021 SH Peak Irongate Stage 2+ Development Level of Service	Figure 8
--	--	-----------------

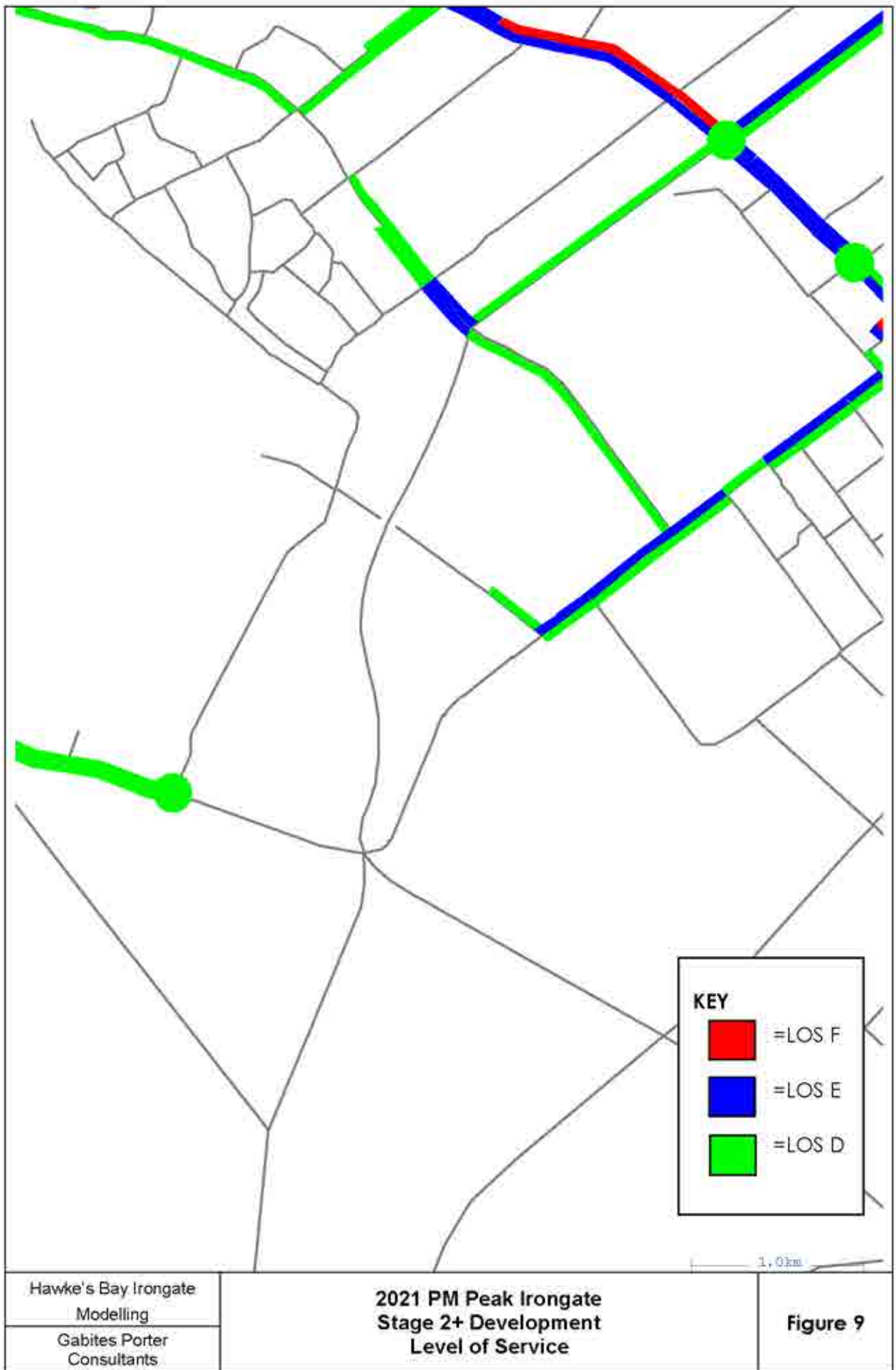

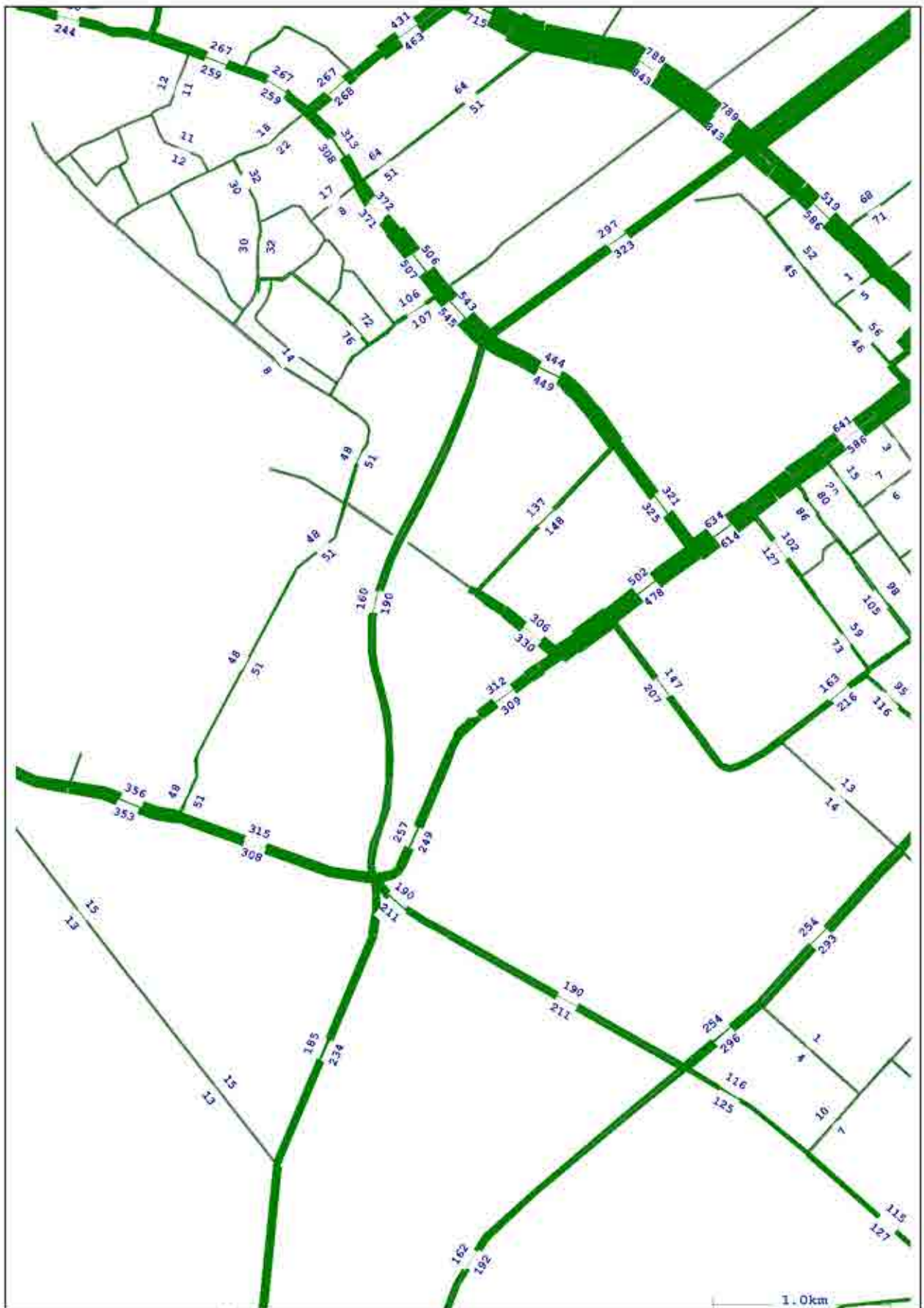

Hawke's Bay Irongate Modelling	2021 SH Peak Irongate with Link Road Stage 2+ Development Traffic Volumes	Figure 11
Gabites Porter Consultants		

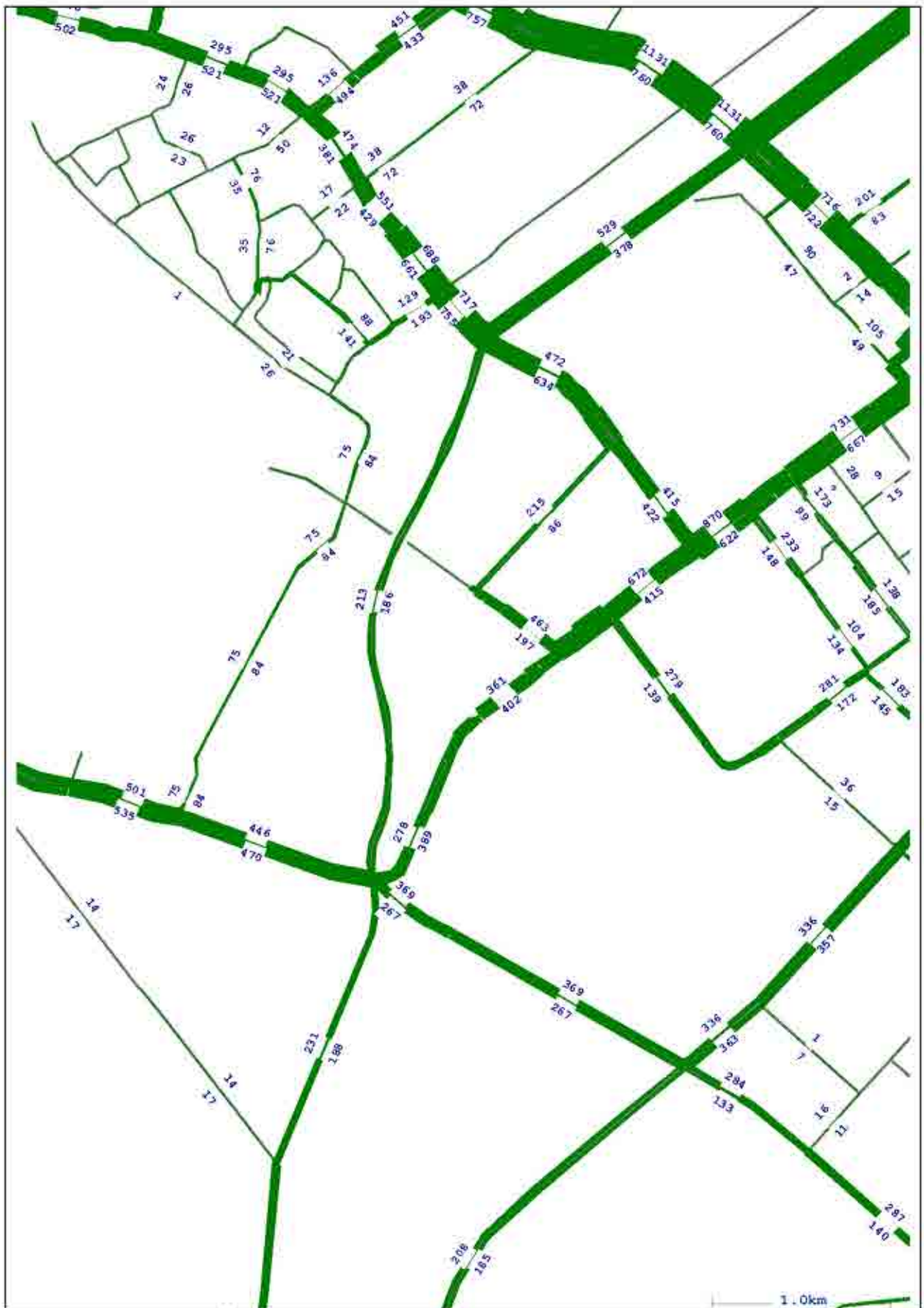

Hawke's Bay Irongate Modelling Gabites Porter Consultants	2021 PM Peak Irongate with Link Road Stage 2+ Development Traffic Volumes	Figure 12
--	--	------------------

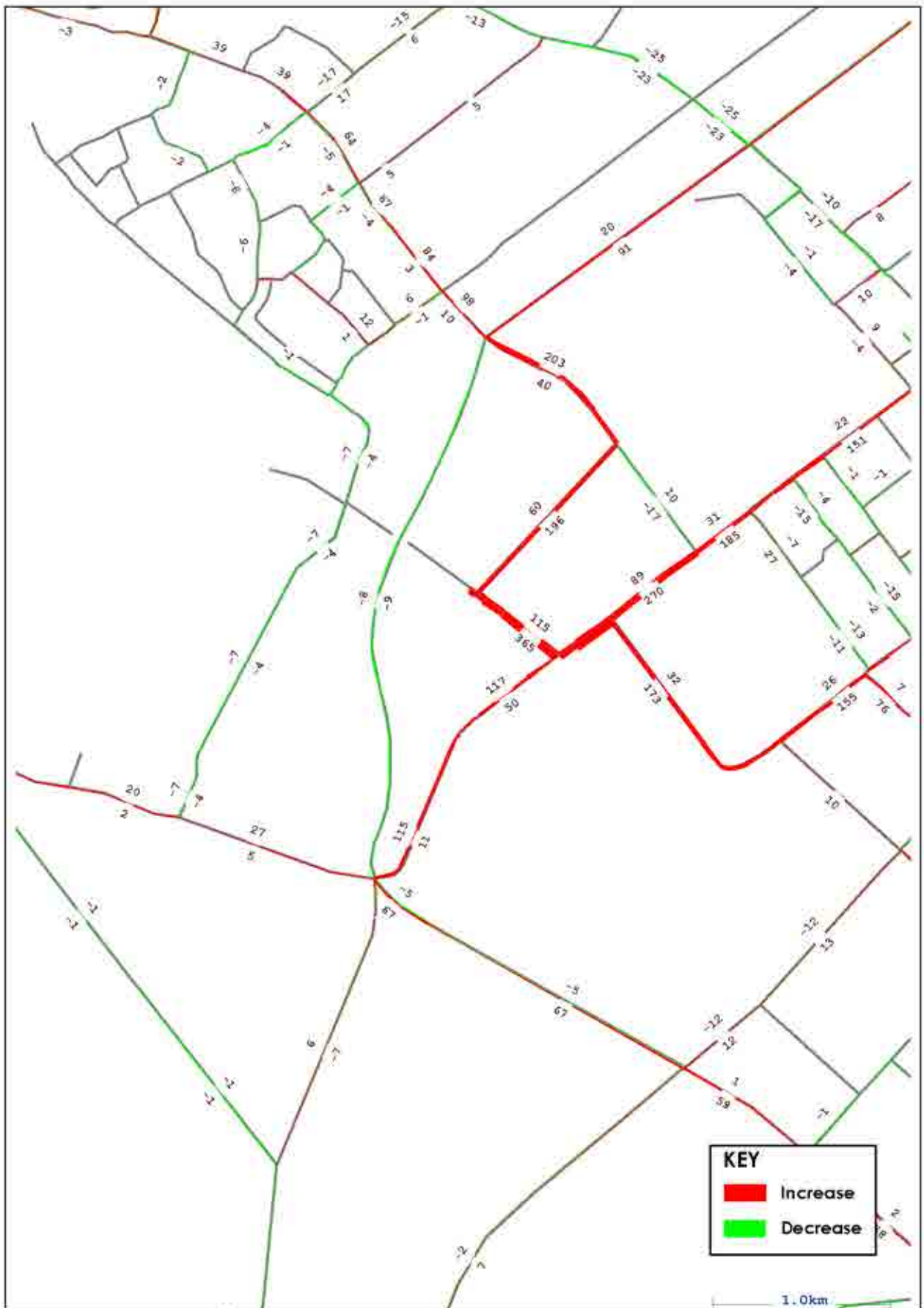

Hawke's Bay Irongate Modelling	2021 AM Peak Irongate with Link Road Stage 2+ Development Change in Traffic Volumes to 2021 Base	Figure 13
Gabites Porter Consultants		

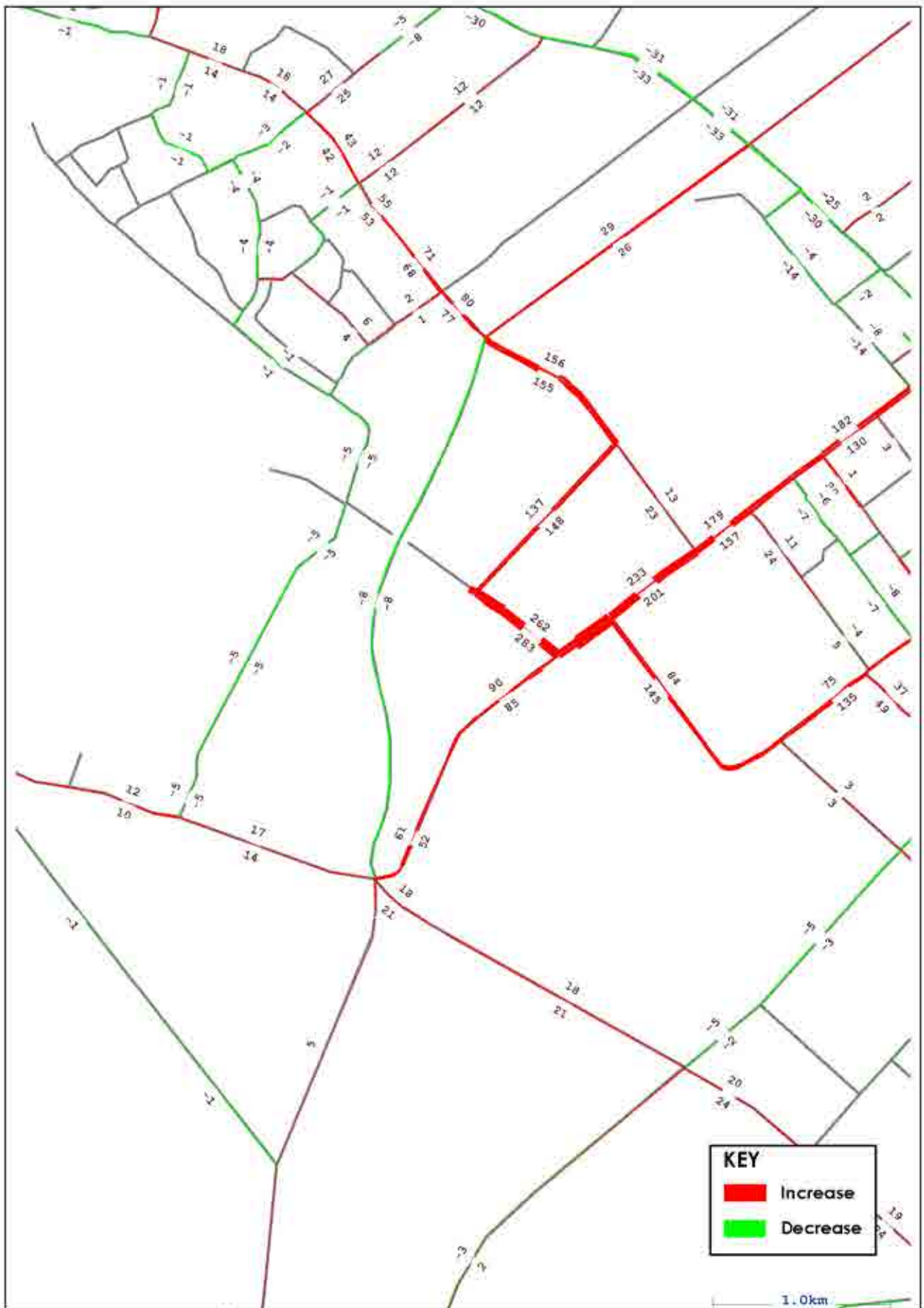

Hawke's Bay Irongate Modelling	2021 SH Peak Irongate with Link Road Stage 2+ Development Change in Traffic Volumes to 2021 Base	Figure 14
Gabites Porter Consultants		

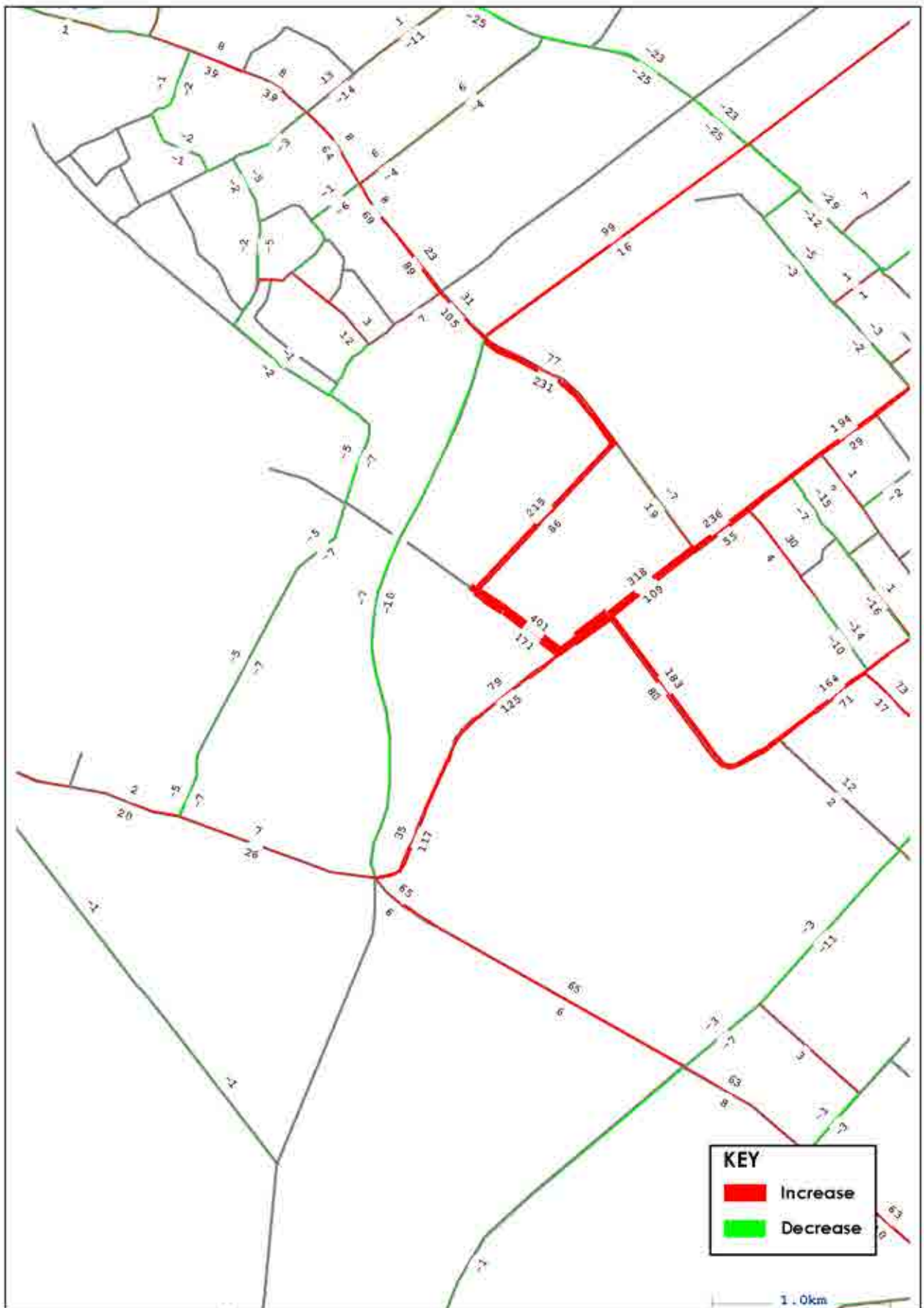

Hawke's Bay Irongate Modelling Gabites Porter Consultants	2021 PM Peak Irongate with Link Road Stage 2+ Development Change in Traffic Volumes to 2021 Base	Figure 15
--	---	------------------

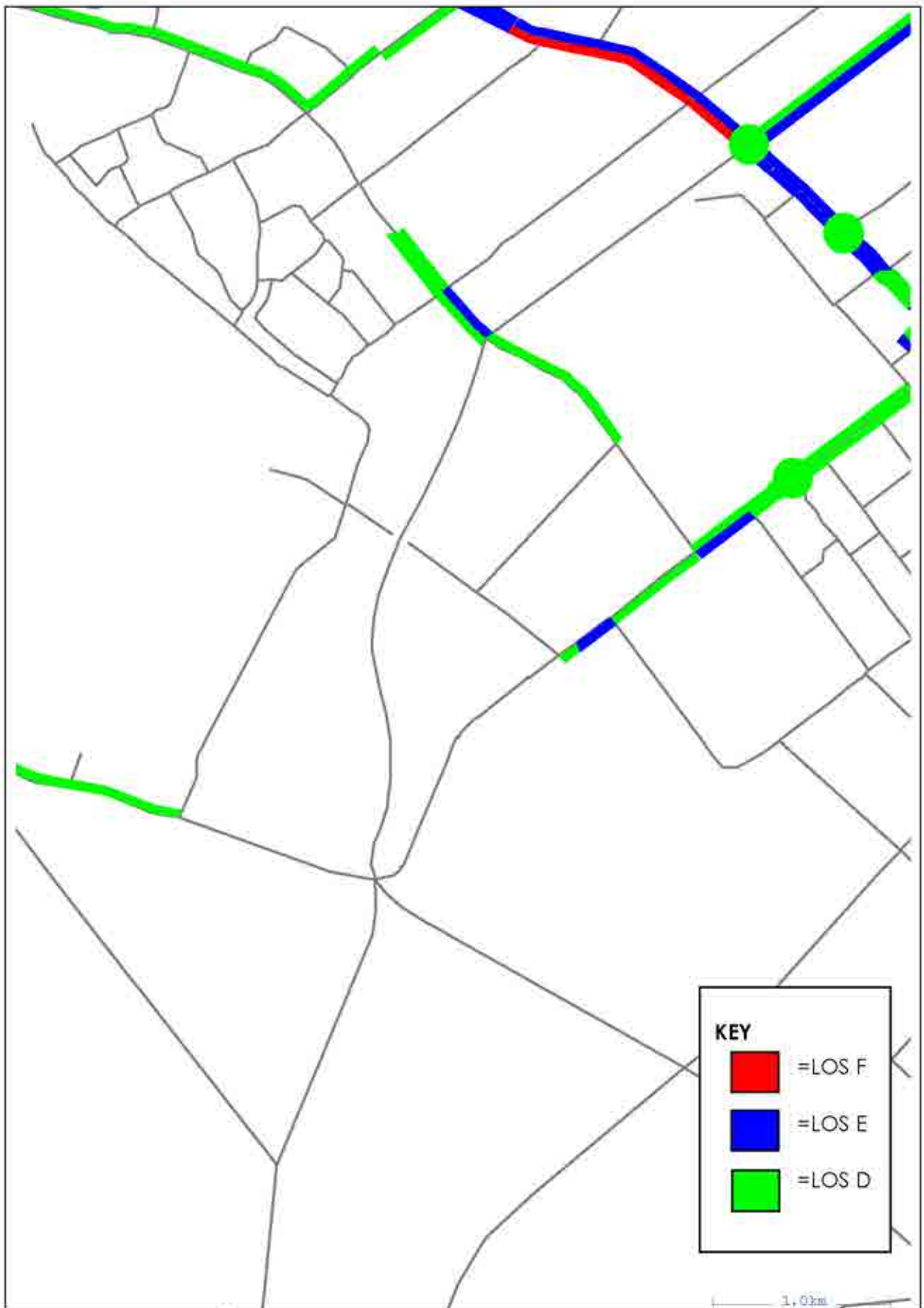

Hawke's Bay Irongate Modelling Gabites Porter Consultants	2021 AM Peak Irongate with Link Road Stage 2+ Development Level of Service	Figure 16
--	---	------------------



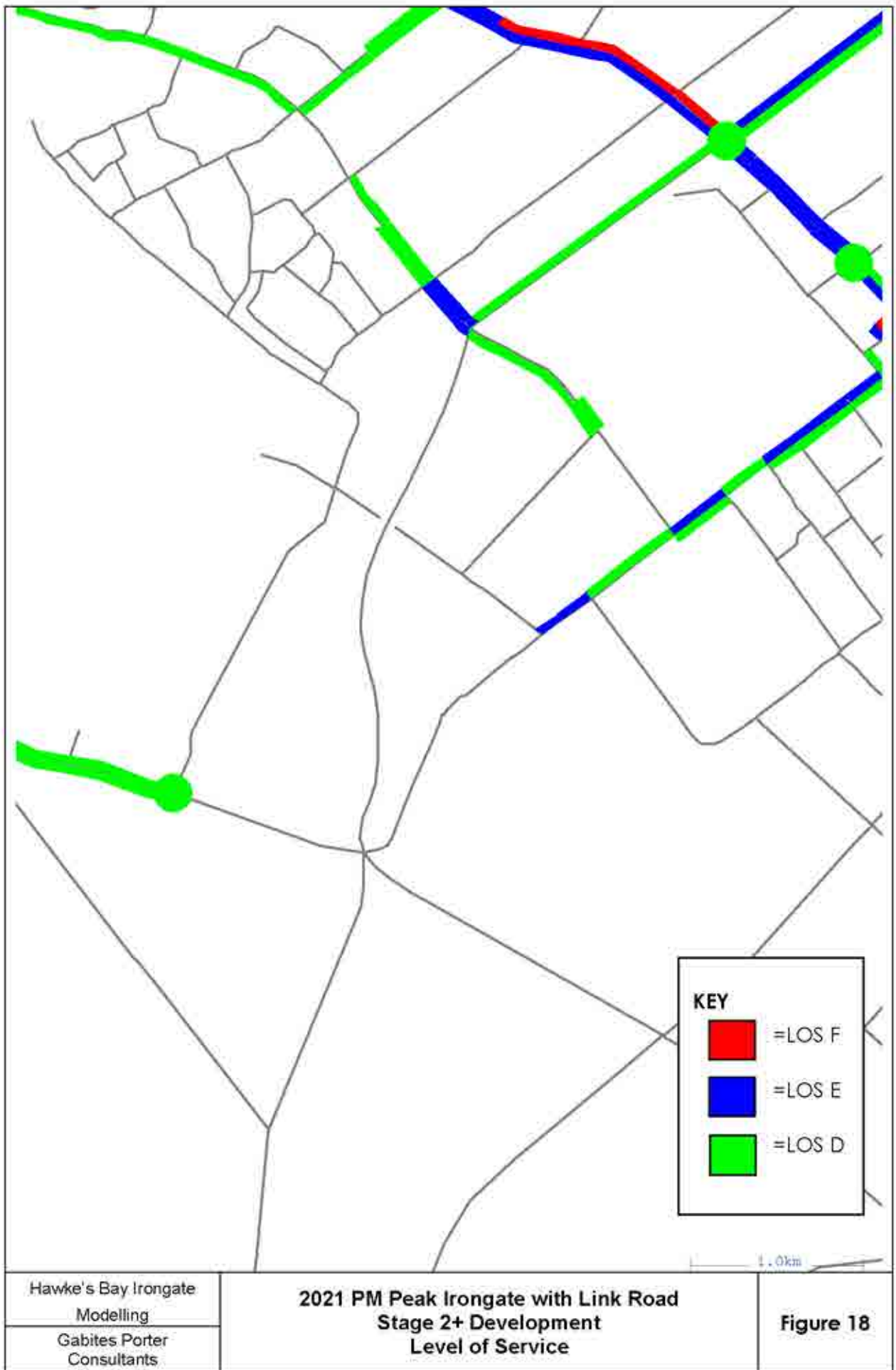

APPENDIX 8

2026 Stage 1:

- With Irongate development
- With Irongate + York Rd Link with Irongate Rd
- With Irongate + Left turn off expressway into Irongate Rd

1. 2026 AM Peak Irongate Stage 1 Development Traffic Volumes	1
2. 2026 SH Peak Irongate Stage 1 Development Traffic Volumes	2
3. 2026 PM Peak Irongate Stage 1 Development Traffic Volumes	3
4. 2026 AM Peak Irongate Stage 1 Development Change in Traffic Volumes to 2026 Base	4
5. 2026 SH Peak Irongate Stage 1 Development Change in Traffic Volumes to 2026 Base	5
6. 2026 PM Peak Irongate Stage 1 Development Change in Traffic Volumes to 2026 Base	6
7. 2026 AM Peak Irongate Stage 1 Development Level of Service	7
8. 2026 SH Peak Irongate Stage 1 Development Level of Service	8
9. 2026 PM Peak Irongate Stage 1 Development Level of Service	9
10. 2026 AM Peak Irongate with Link Road Stage 1 Development Traffic Volumes	10
11. 2026 SH Peak Irongate with Link Road Stage 1 Development Traffic Volumes	11
12. 2026 PM Peak EX Irongate with Link Road Stage 1 Development Traffic Volumes	12
13. 2026 AM Peak Irongate with Link Road Stage 1 Development Change in Traffic Volumes to 2026 Base	13
14. 2026 SH Peak Irongate with Link Road Stage 1 Development Change in Traffic Volumes to 2026 Base	14
15. 2026 PM Peak Irongate with Link Road Stage 1 Development Change in Traffic Volumes to 2026 Base	15
16. 2026 AM Peak Irongate with Link Road Stage 1 Development Level of Service	16
17. 2026 SH Peak Irongate with Link Road Stage 1 Development Level of Service	17
18. 2026 PM Peak Irongate with Link Road Stage 1 Development Level of Service	18

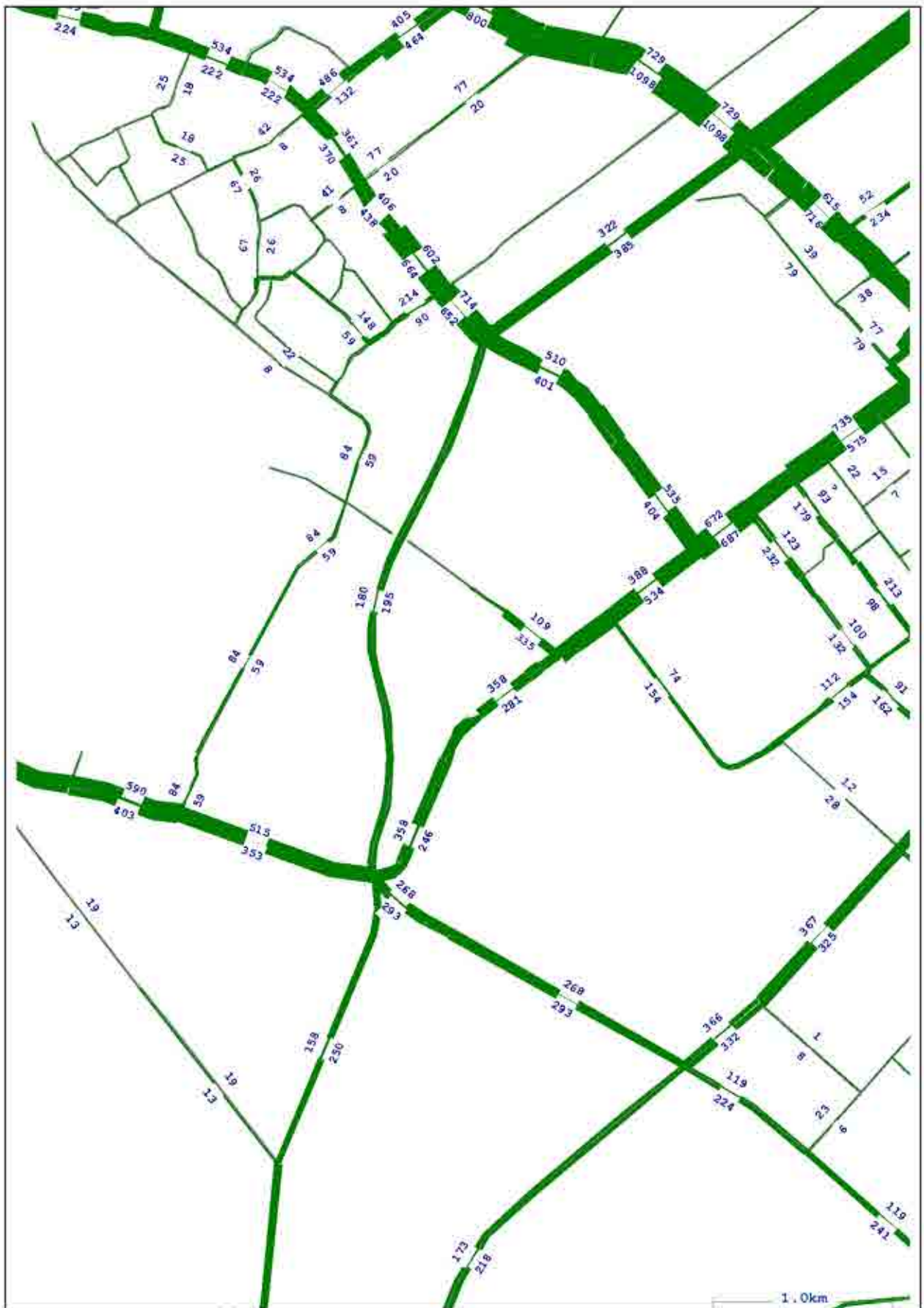

Hawke's Bay Irongate Modelling	2026 AM Peak Irongate Stage 1 Development Traffic Volumes	Figure 1
Gabites Porter Consultants		

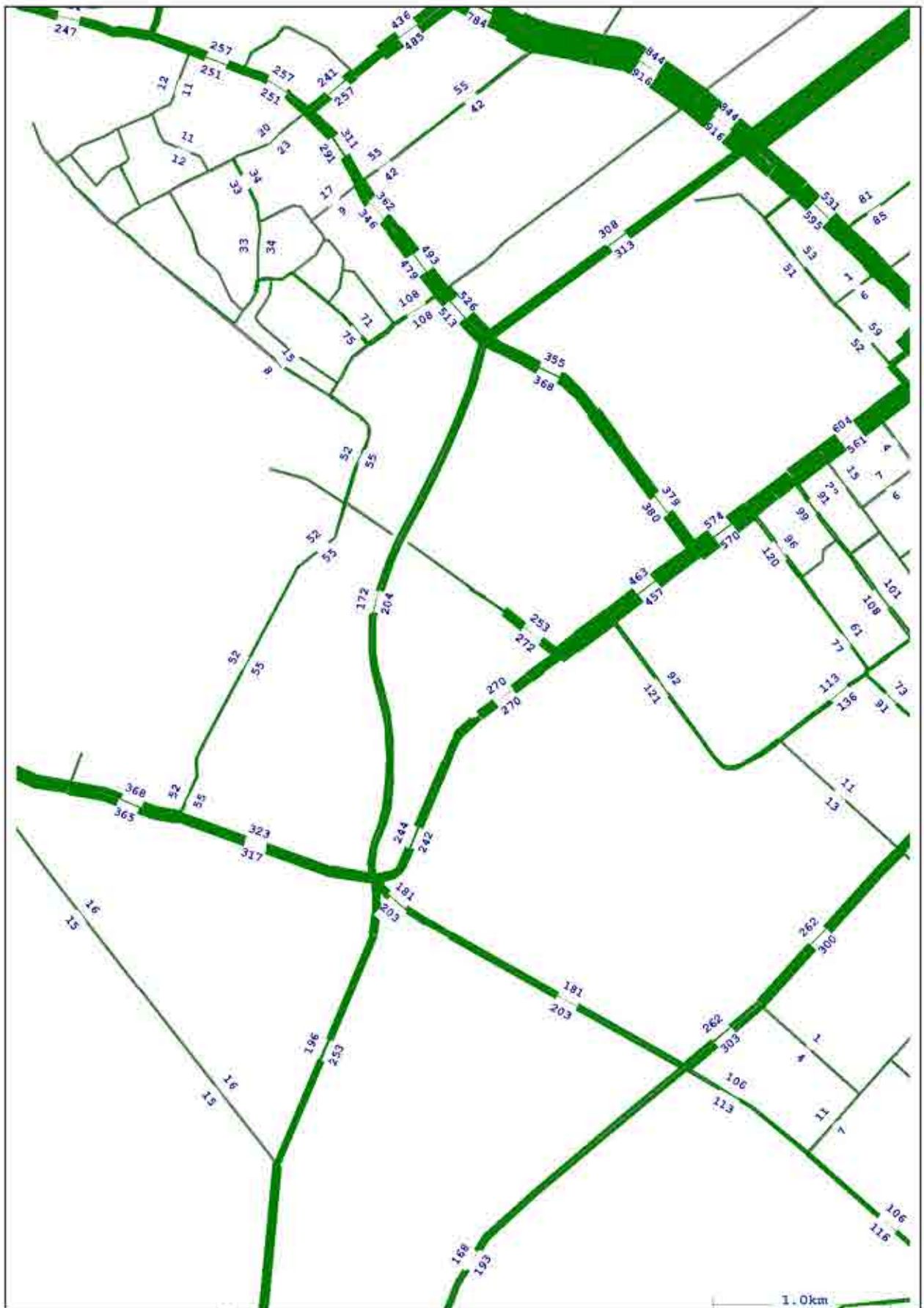

Hawke's Bay Irongate Modelling	2026 SH Peak Irongate Stage 1 Development Traffic Volumes	Figure 2
Gabites Porter Consultants		

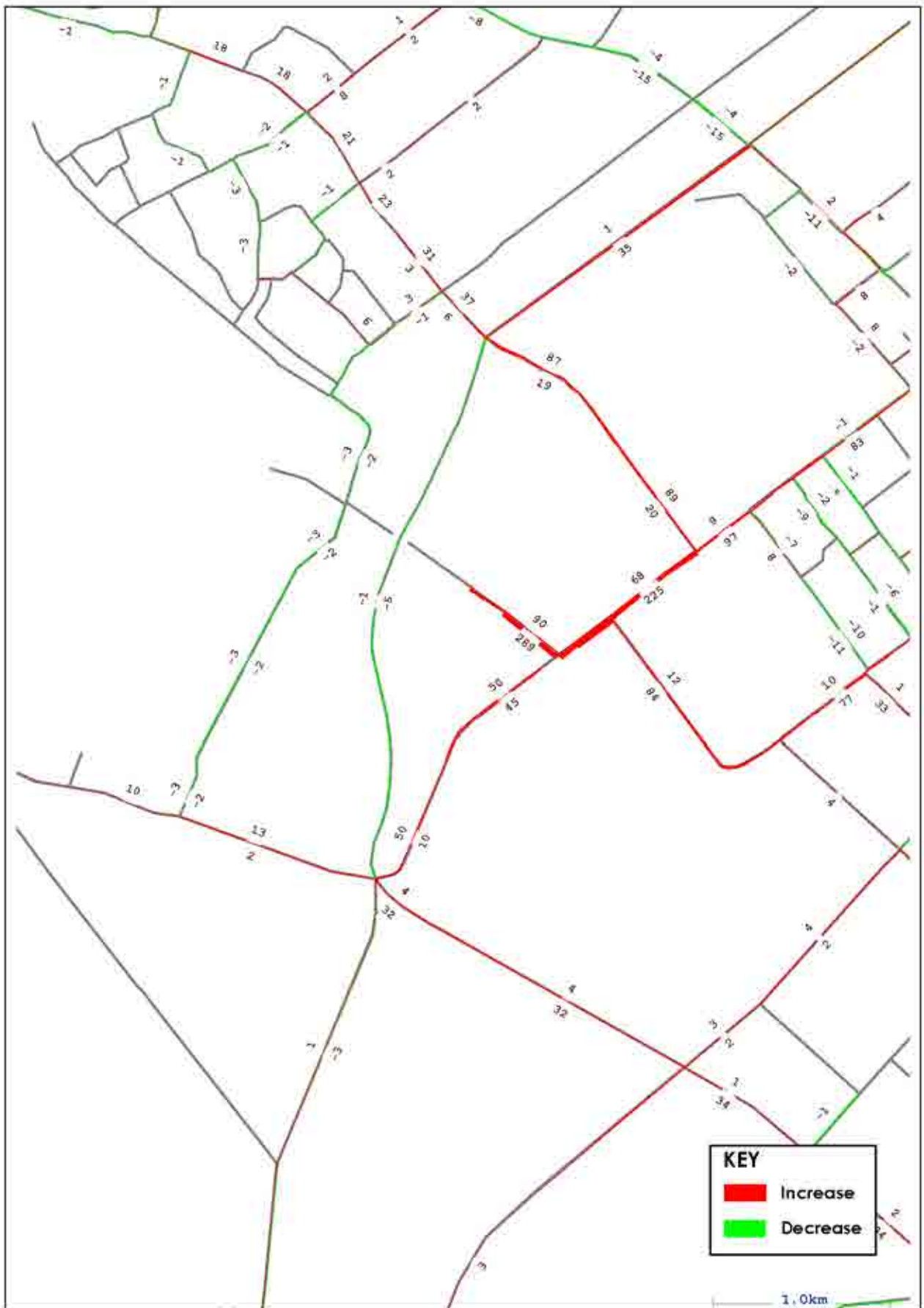

Hawke's Bay Irongate Modelling Gabites Porter Consultants	2026 AM Peak Irongate Stage 1 Development Change in Traffic Volumes to 2026 Base	Figure 4
--	---	-----------------

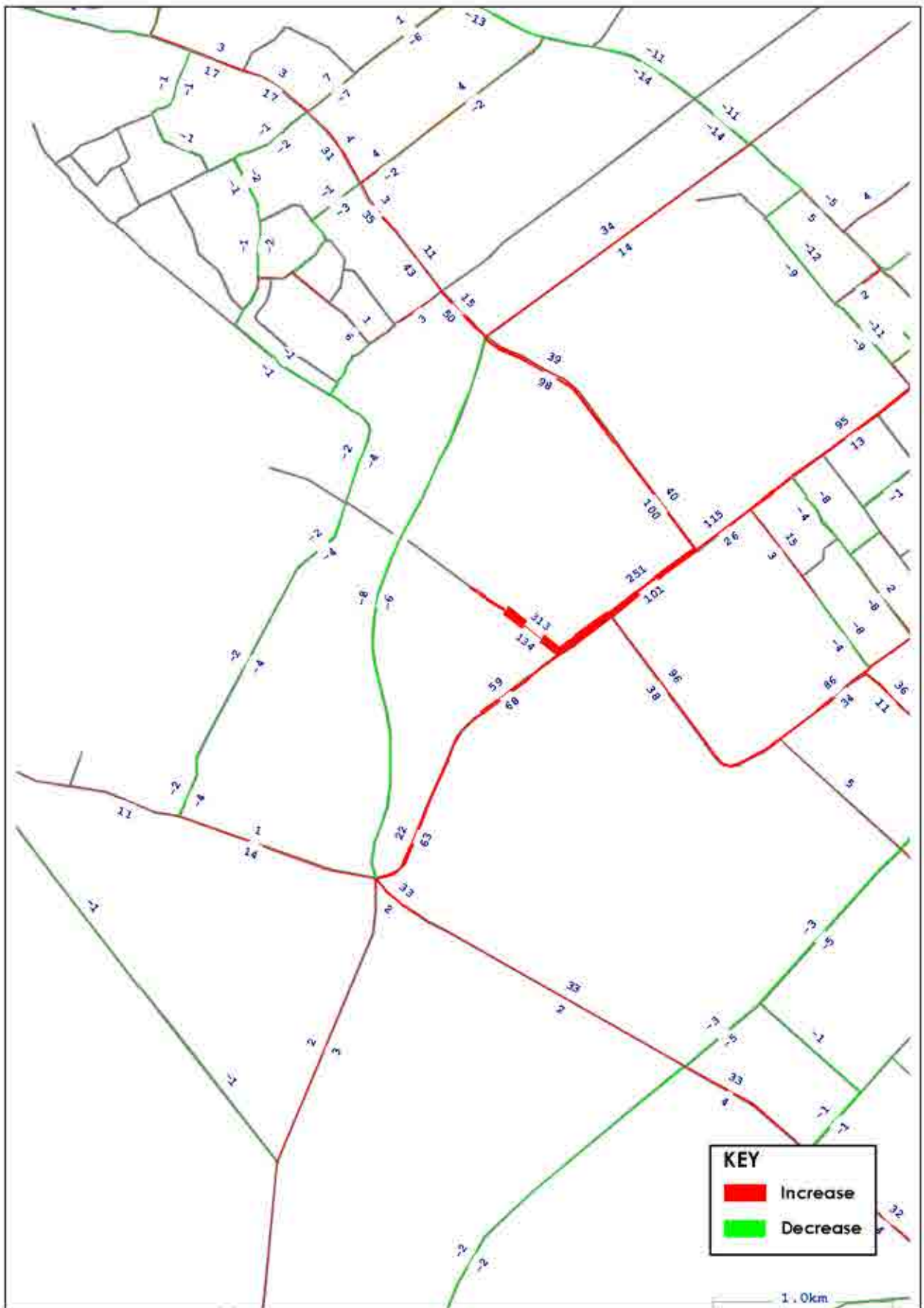

Hawke's Bay Irongate
Modelling
Gabites Porter
Consultants

**2026 PM Peak Irongate
Stage 1 Development
Change in Traffic Volumes to 2026 Base**

Figure 6

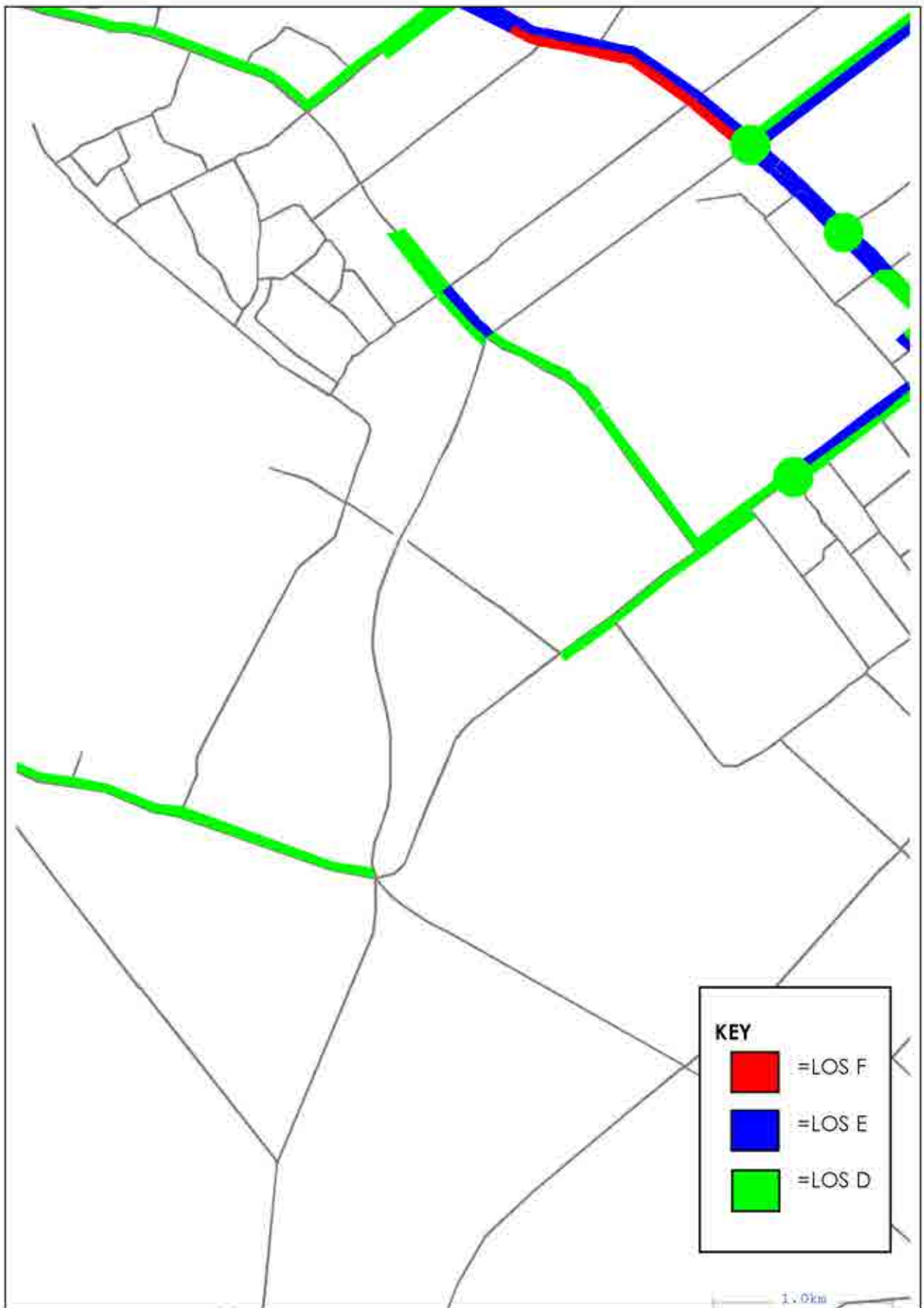

Hawke's Bay Irongate Modelling Gabites Porter Consultants	2026 AM Peak Irongate Stage 1 Development Level of Service	Figure 7
--	---	-----------------





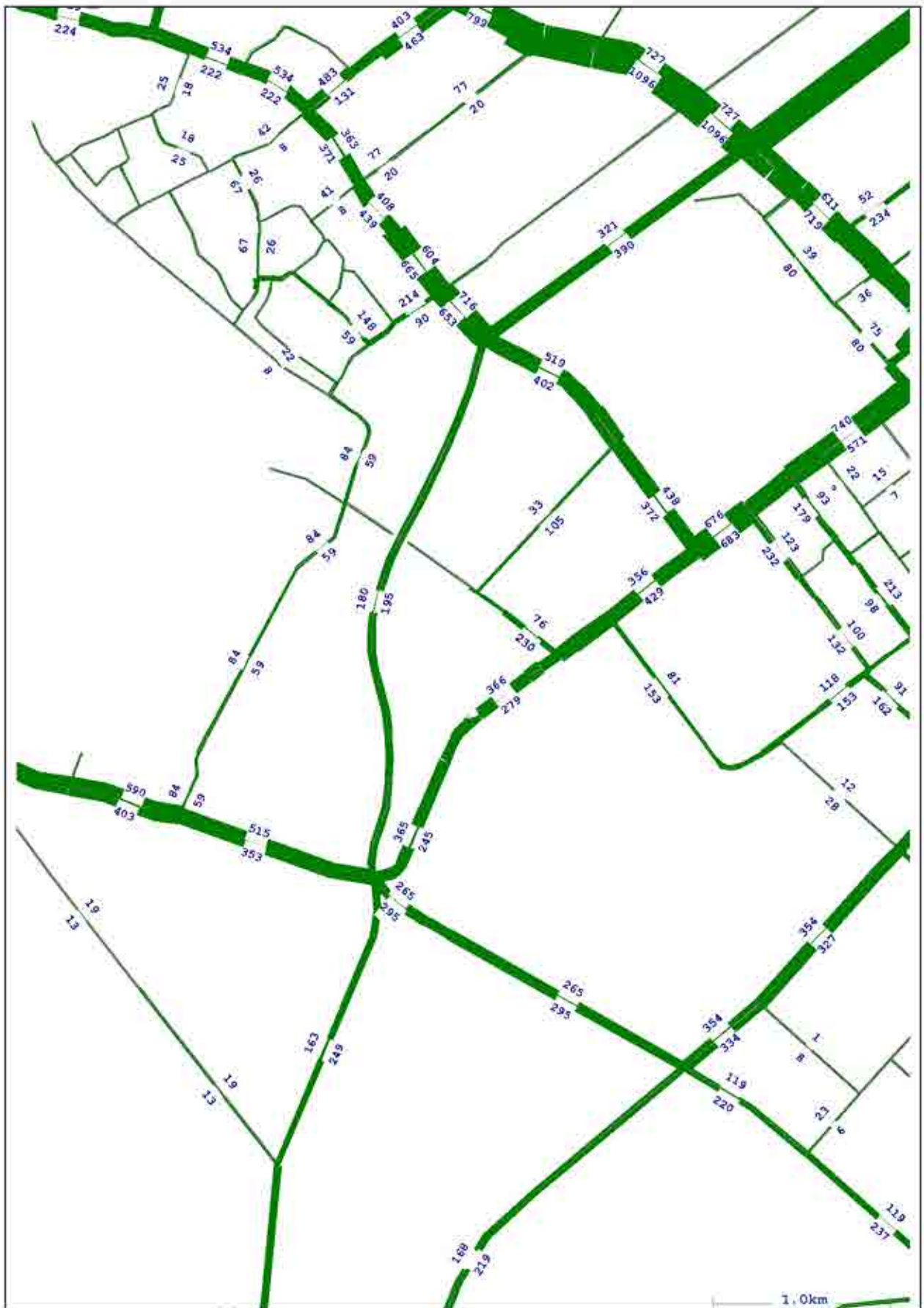

Hawke's Bay Irongate Modelling	2026 AM Peak Irongate with Link Road Stage 1 Development Traffic Volumes	Figure 10
Gabites Porter Consultants		

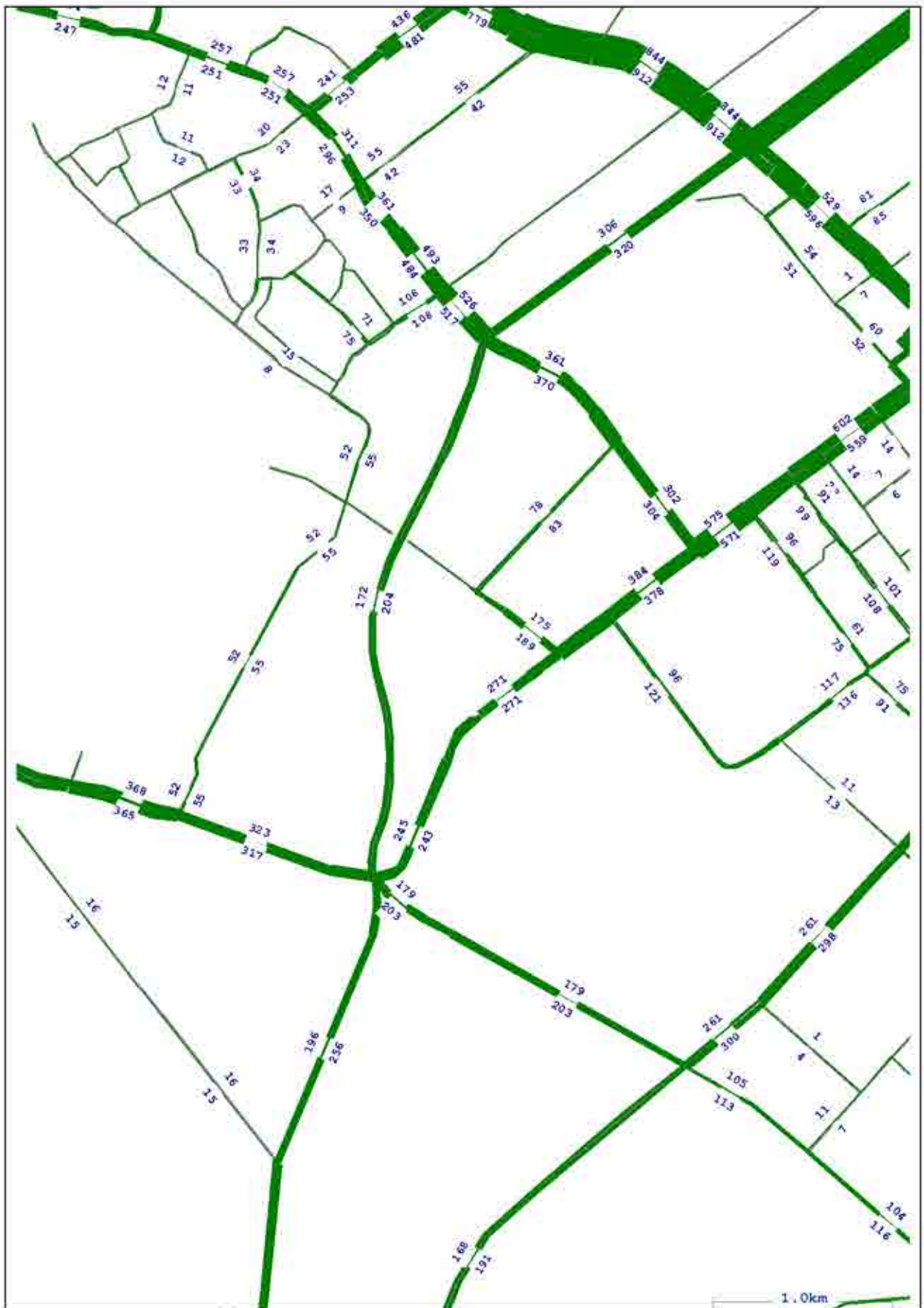

Hawke's Bay Irongate Modelling	2026 SH Peak Irongate with Link Road Stage 1 Development Traffic Volumes	Figure 11
Gabites Porter Consultants		

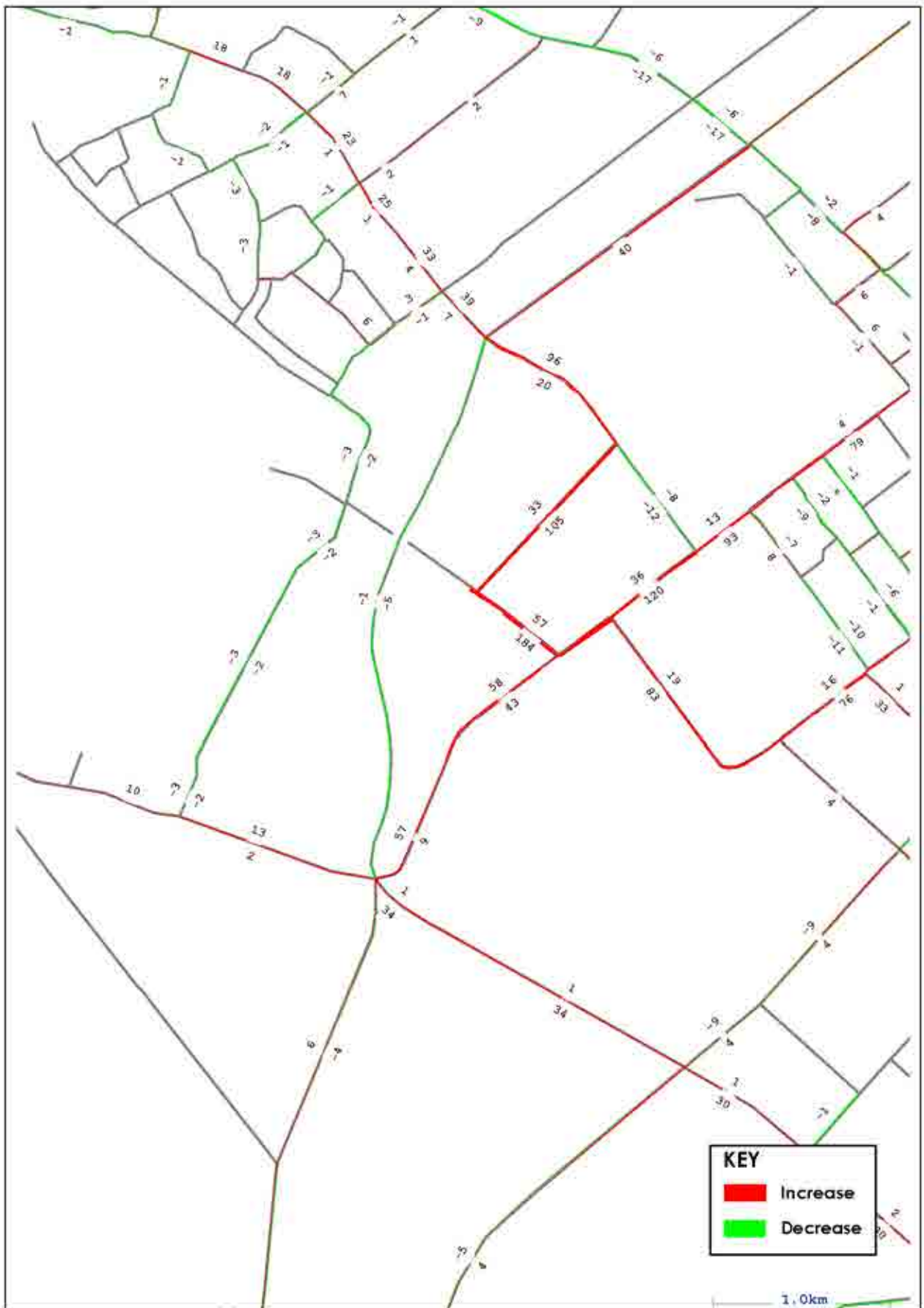

Hawke's Bay Irongate Modelling Gabites Porter Consultants	2026 AM Peak Irongate with Link Road Stage 1 Development Change in Traffic Volumes to 2026 Base	Figure 13
--	--	------------------

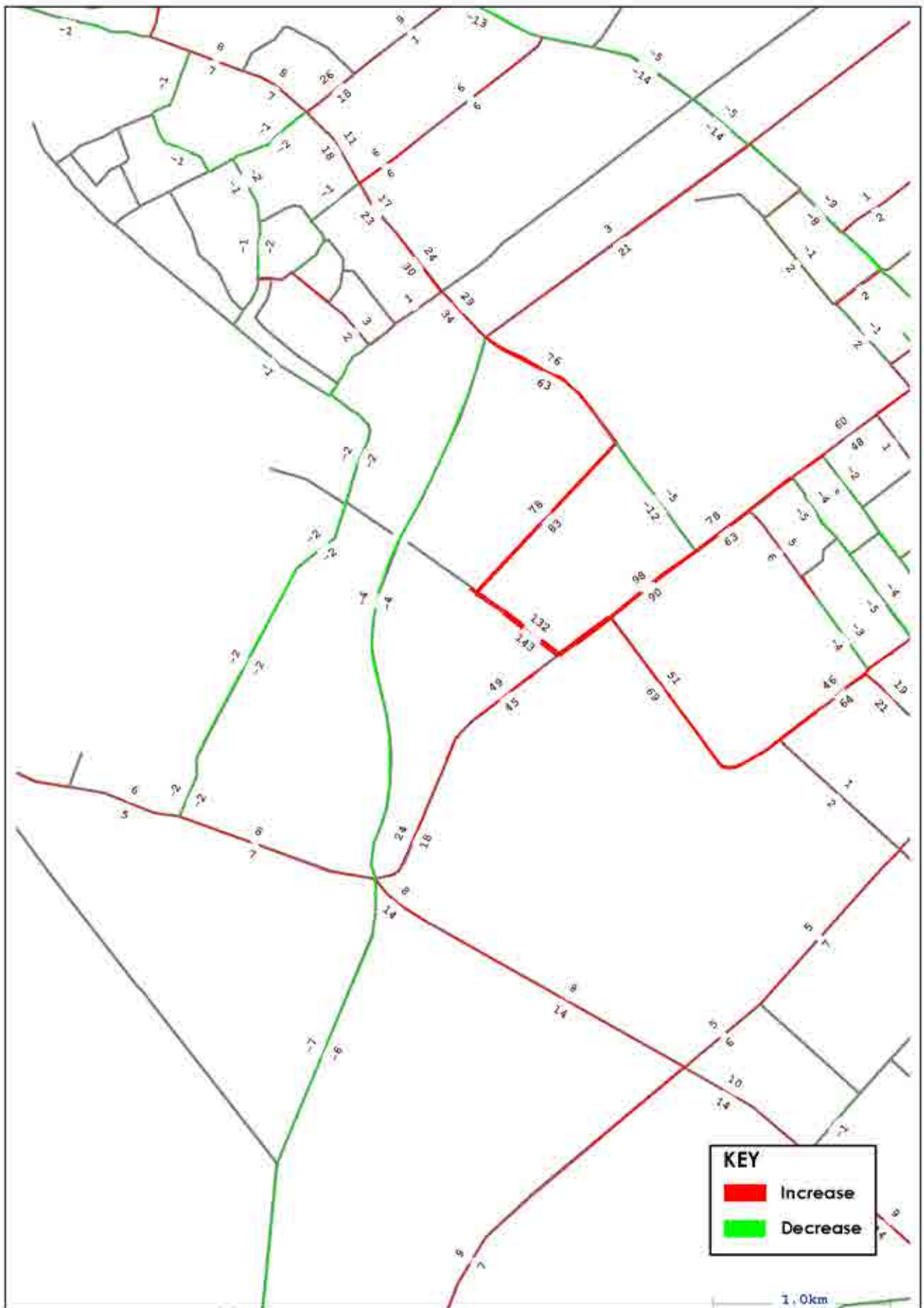

Hawke's Bay Irongate Modelling Gabites Porter Consultants	2026 SH Peak Irongate with Link Road Stage 1 Development Change in Traffic Volumes to 2026 Base	Figure 14
--	--	------------------

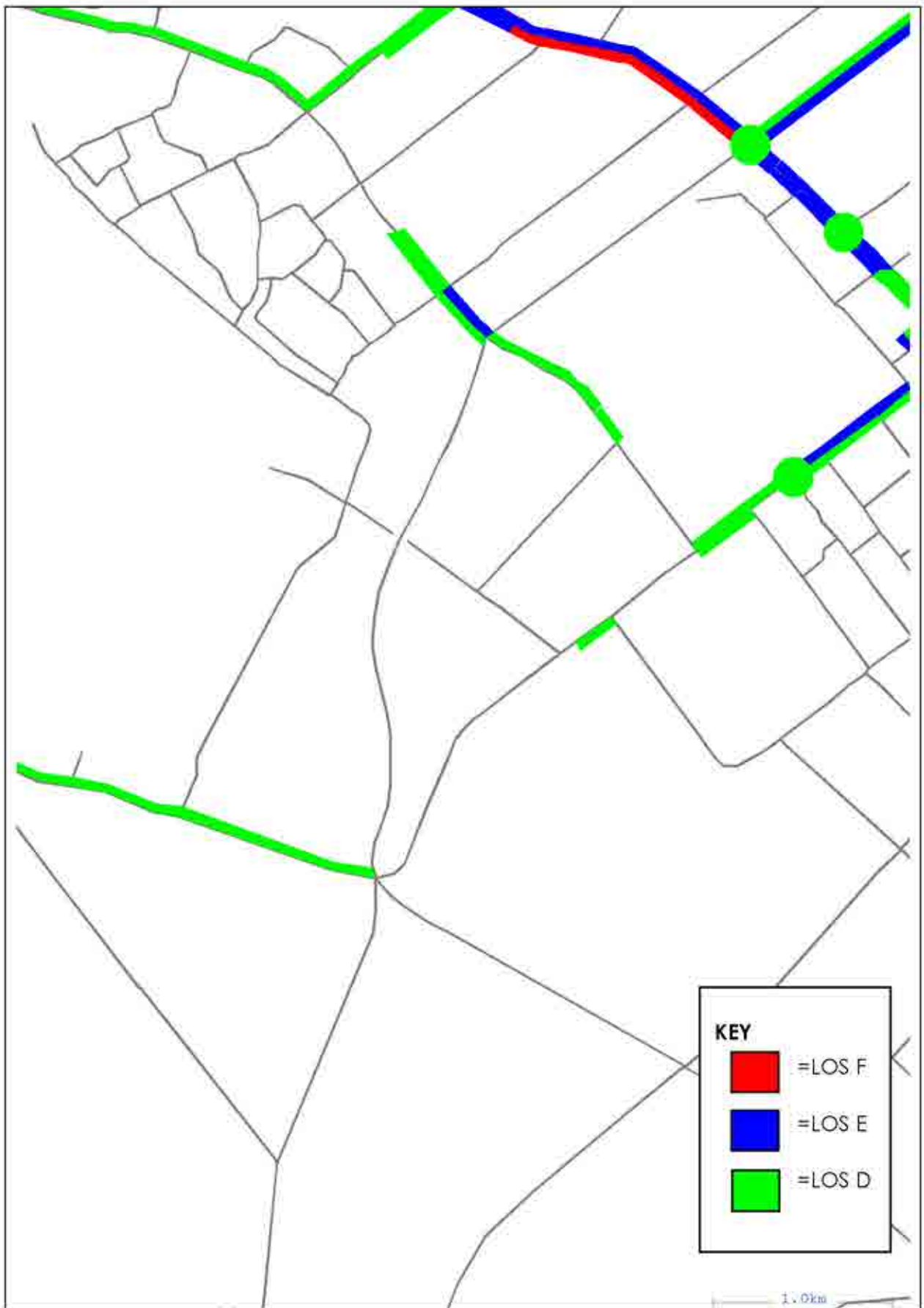

Hawke's Bay Irongate Modelling Gabites Porter Consultants	2026 AM Peak Irongate with Link Road Stage 1 Development Level of Service	Figure 16
--	--	------------------

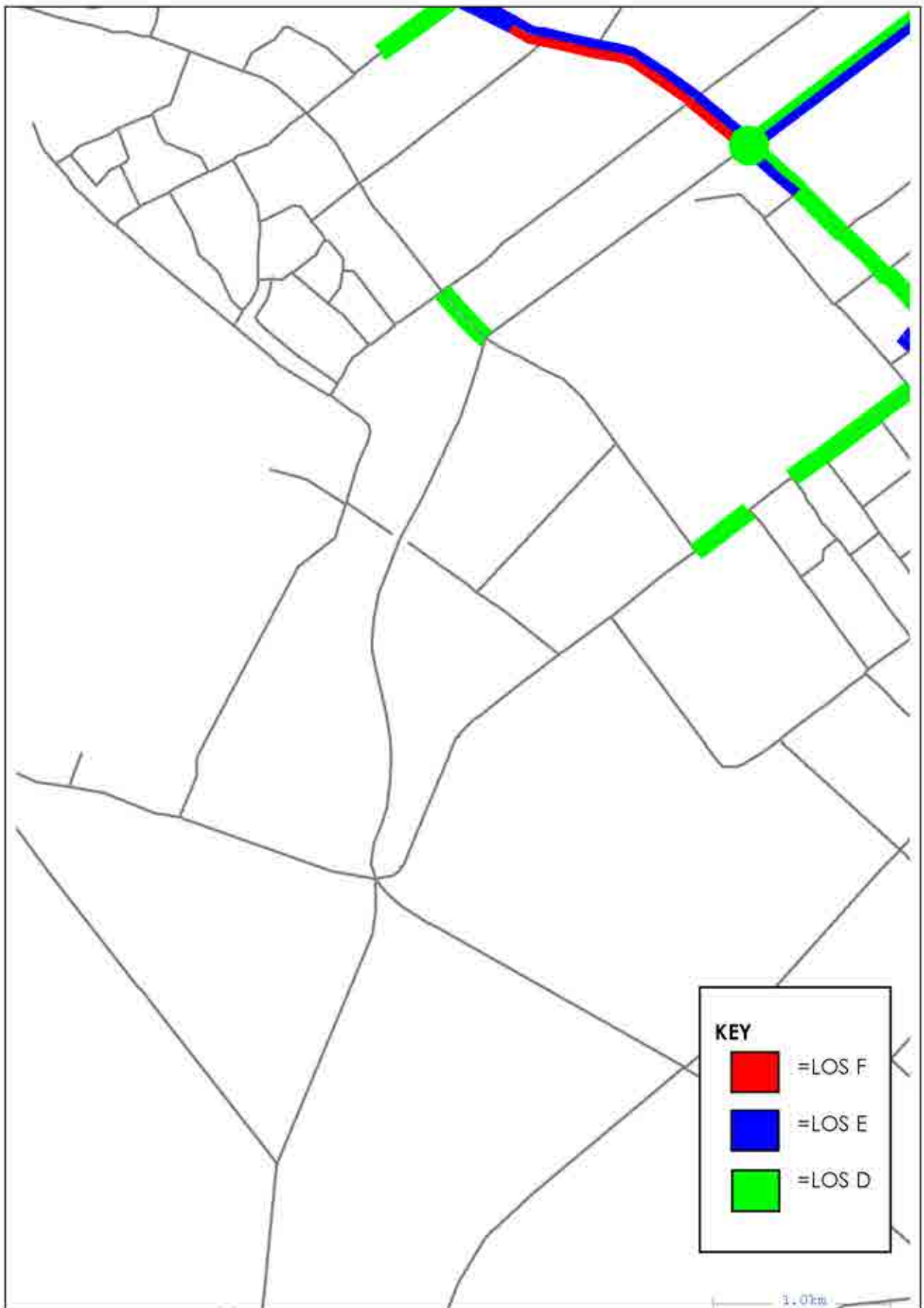

Hawke's Bay Irongate Modelling Gabites Porter Consultants	2026 SH Peak Irongate with Link Road Stage 1 Development Level of Service	Figure 17
--	--	------------------

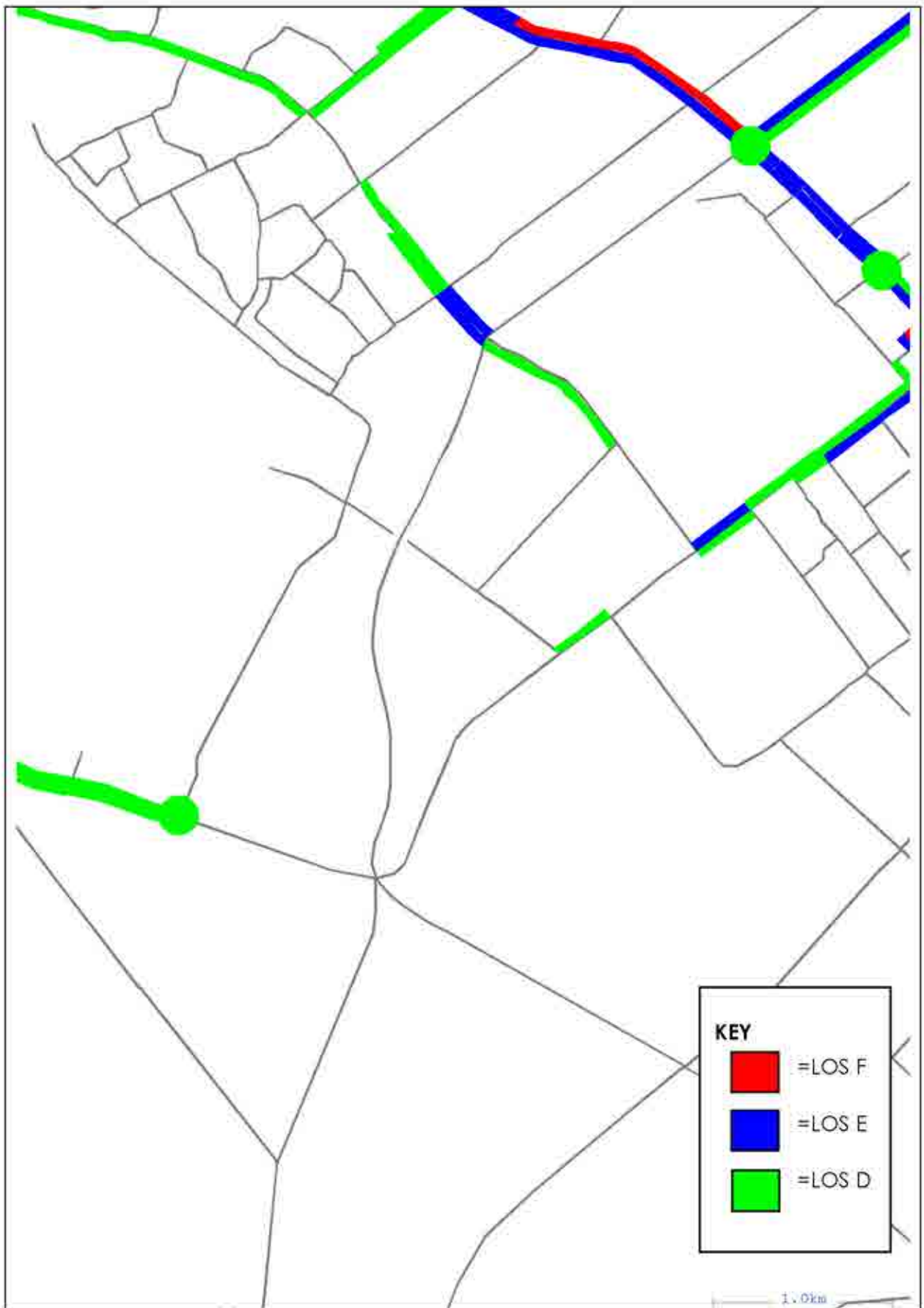

Hawke's Bay Irongate Modelling Gabites Porter Consultants	2026 PM Peak Irongate with Link Road Stage 1 Development Level of Service	Figure 18
--	--	------------------

APPENDIX 9

2026 Stage 1+:

- With Irongate
- With Irongate + York Rd Link with Irongate Rd
- With Irongate + Left turn off expressway into Irongate Rd

1. 2026 AM Peak Irongate Stage 1+ Development Traffic Volumes	1
2. 2026 SH Peak Irongate Stage 1+ Development Traffic Volumes	2
3. 2026 PM Peak Irongate Stage 1+ Development Traffic Volumes	3
4. 2026 AM Peak Irongate Stage 1+ Development Change in Traffic Volumes to 2026 Base	4
5. 2026 SH Peak Irongate Stage 1+ Development Change in Traffic Volumes to 2026 Base	5
6. 2026 PM Peak Irongate Stage 1+ Development Change in Traffic Volumes to 2026 Base	6
7. 2026 AM Peak Irongate Stage 1+ Development Level of Service	7
8. 2026 SH Peak Irongate Stage 1+ Development Level of Service	8
9. 2026 PM Peak Irongate Stage 1+ Development Level of Service	9
10. 2026 AM Peak Irongate with Link Road Stage 1+ Development Traffic Volumes	10
11. 2026 SH Peak Irongate with Link Road Stage 1+ Development Traffic Volumes	11
12. 2026 PM Peak Irongate with Link Road Stage 1+ Development Traffic Volumes	12
13. 2026 AM Peak Irongate with Link Road Stage 1+ Development Change in Traffic Volumes to 2026 Base	13
14. 2026 SH Peak Irongate with Link Road Stage 1+ Development Change in Traffic Volumes to 2026 Base	14
15. 2026 PM Peak Irongate with Link Road Stage 1+ Development Change in Traffic Volumes to 2026 Base	15
16. 2026 AM Peak Irongate with Link Road Stage 1+ Development Level of Service	16
17. 2026 SH Peak Irongate with Link Road Stage 1+ Development Level of Service	17
18. 2026 PM Peak Irongate with Link Road Stage 1+ Development Level of Service	18

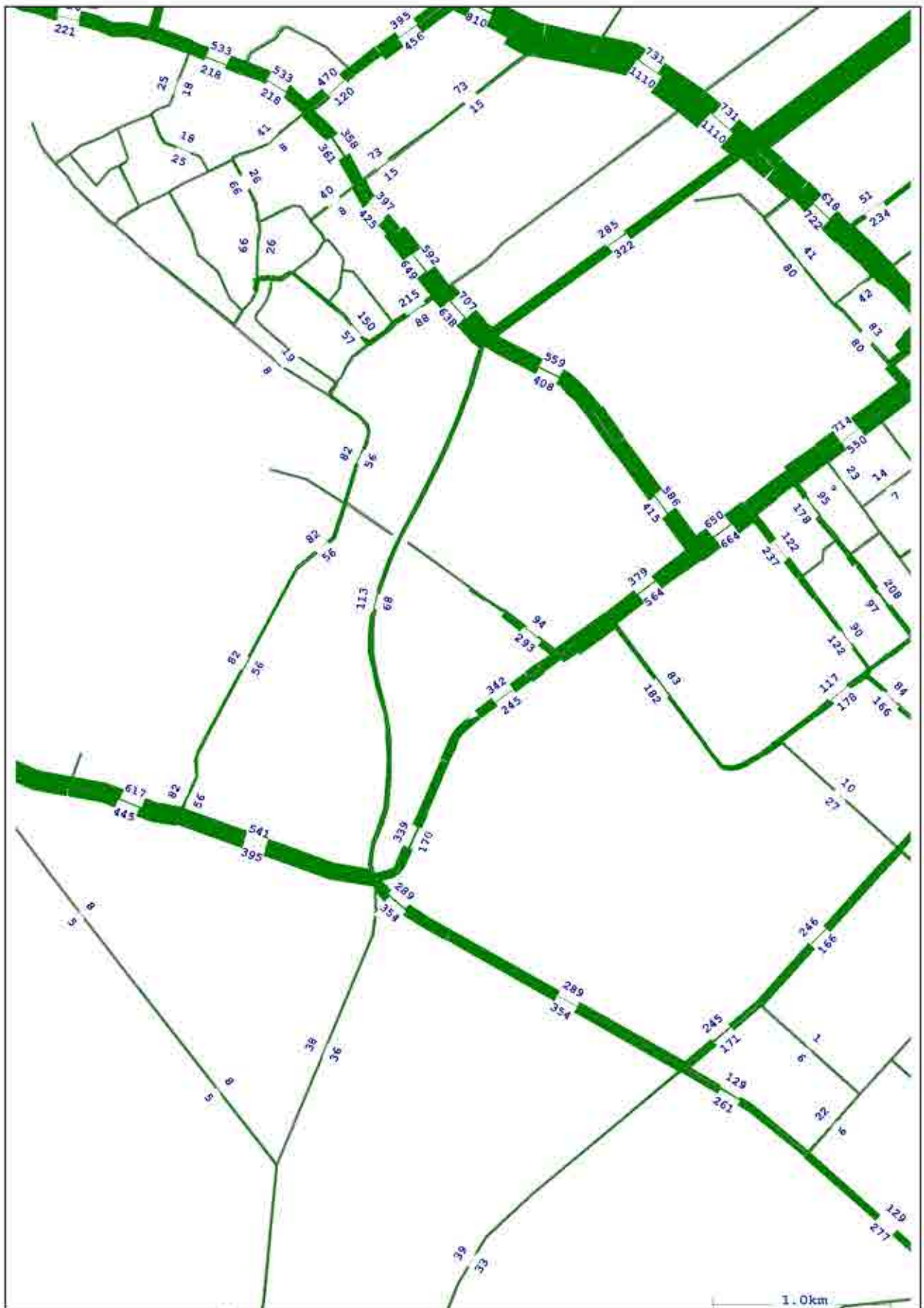

Hawke's Bay Irongate Modelling	2026 AM Peak Irongate Stage 1+ Development Traffic Volumes	Figure 1
Gabites Porter Consultants		

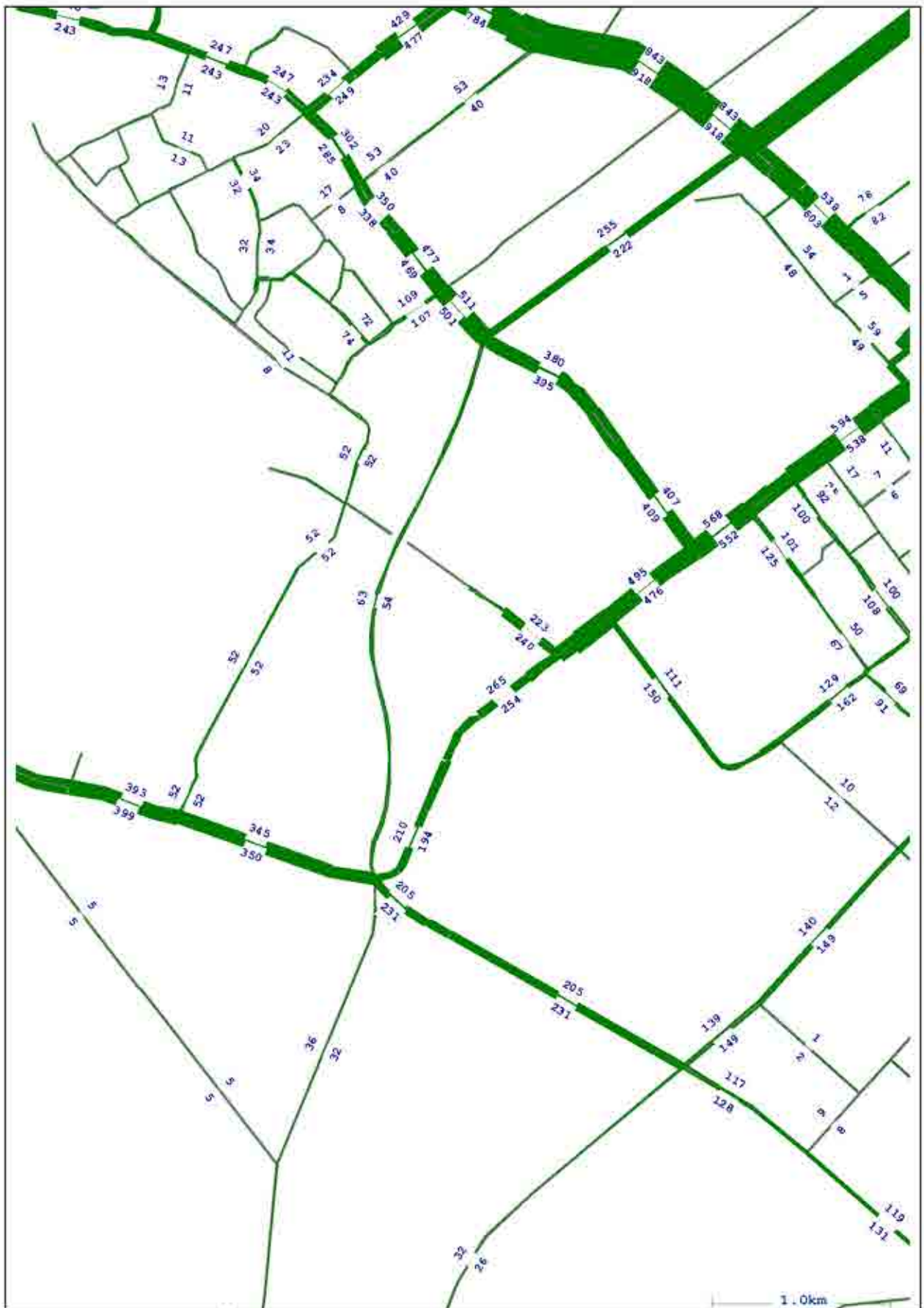

Hawke's Bay Irongate Modelling	2026 SH Peak Irongate Stage 1+ Development Traffic Volumes	Figure 2
Gabites Porter Consultants		

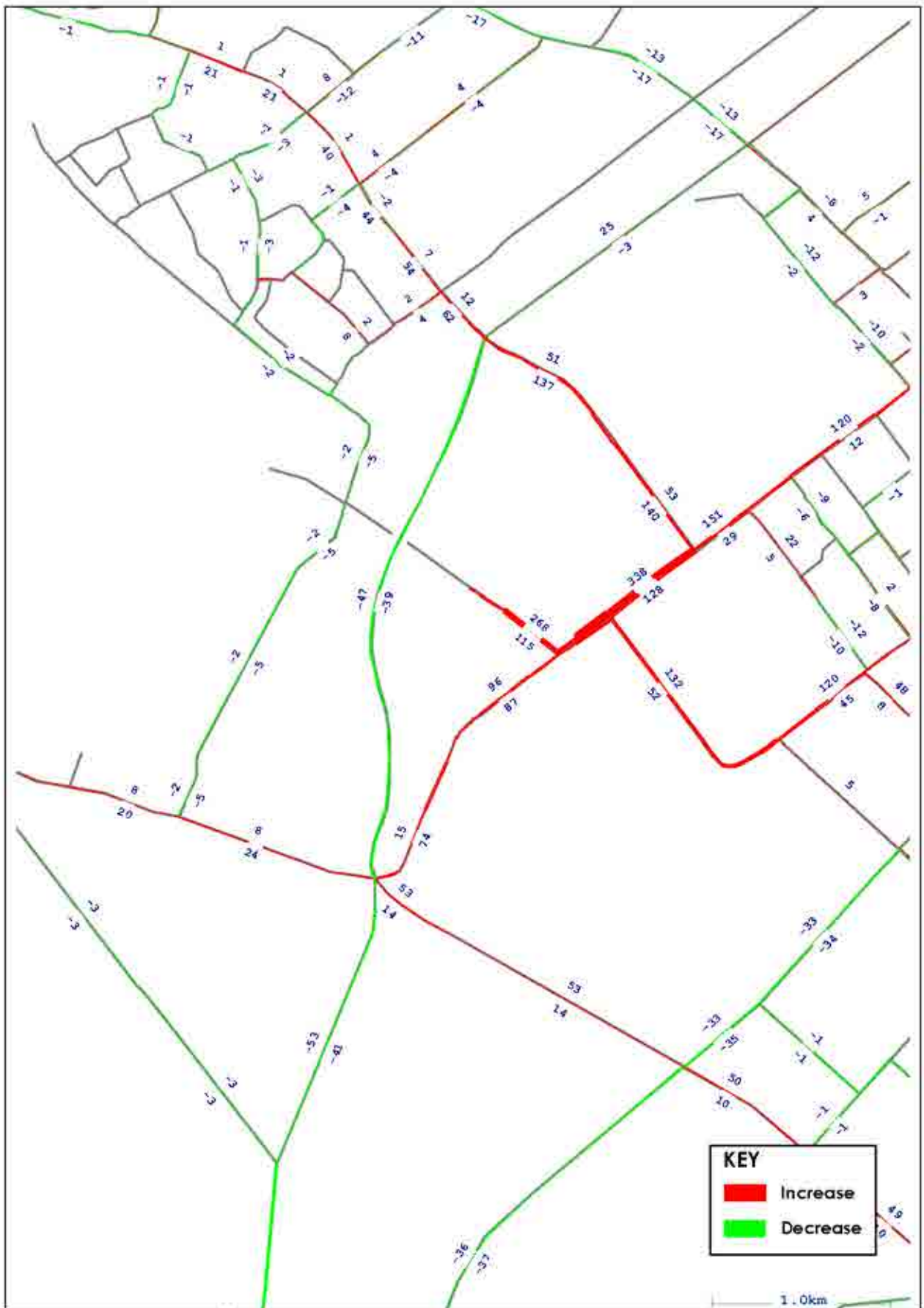

Hawke's Bay Irongate Modelling	2026 PM Peak Irongate Stage 1+ Development Change in Traffic Volumes to 2026 Base	Figure 6
Gabites Porter Consultants		

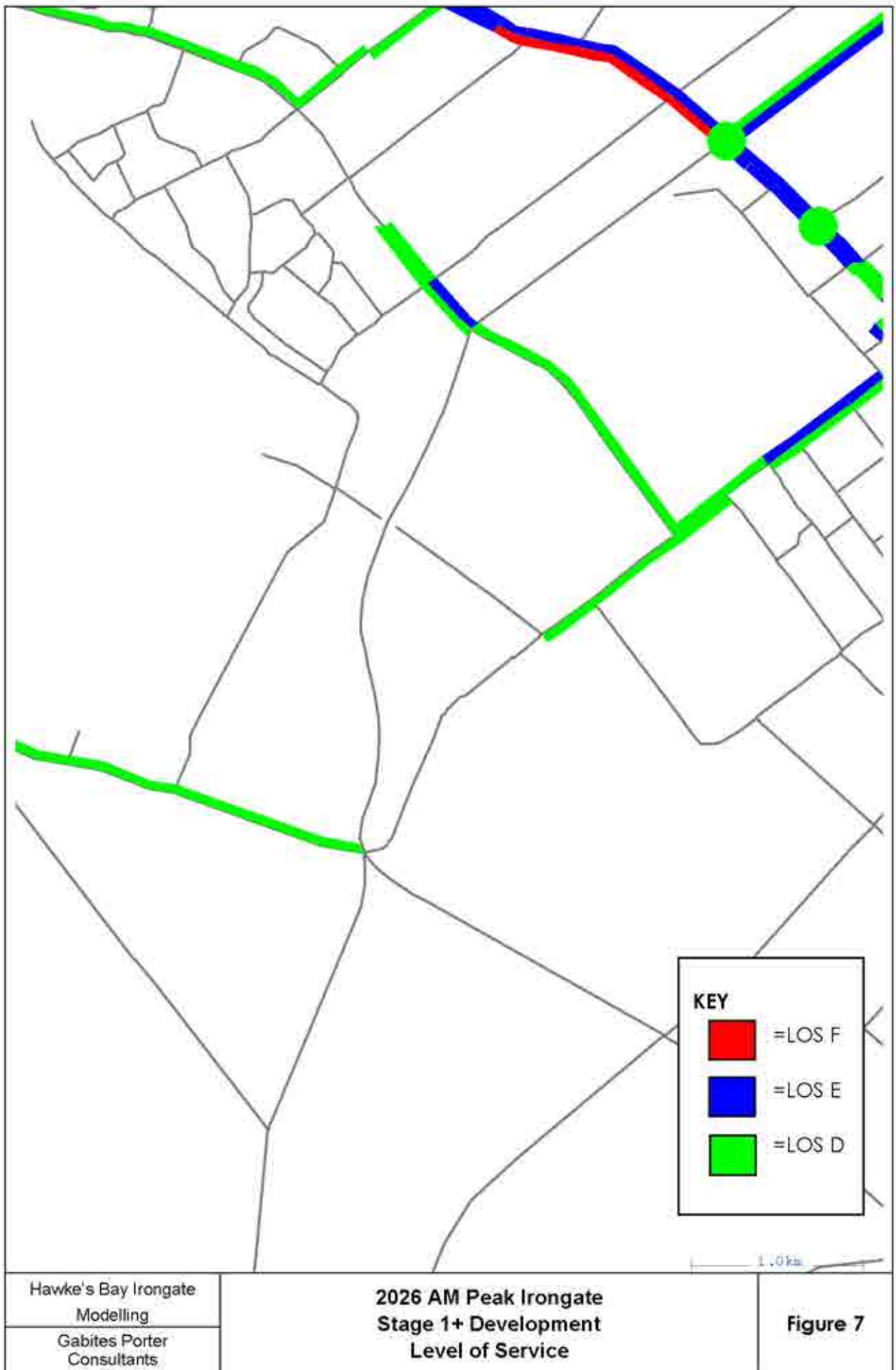



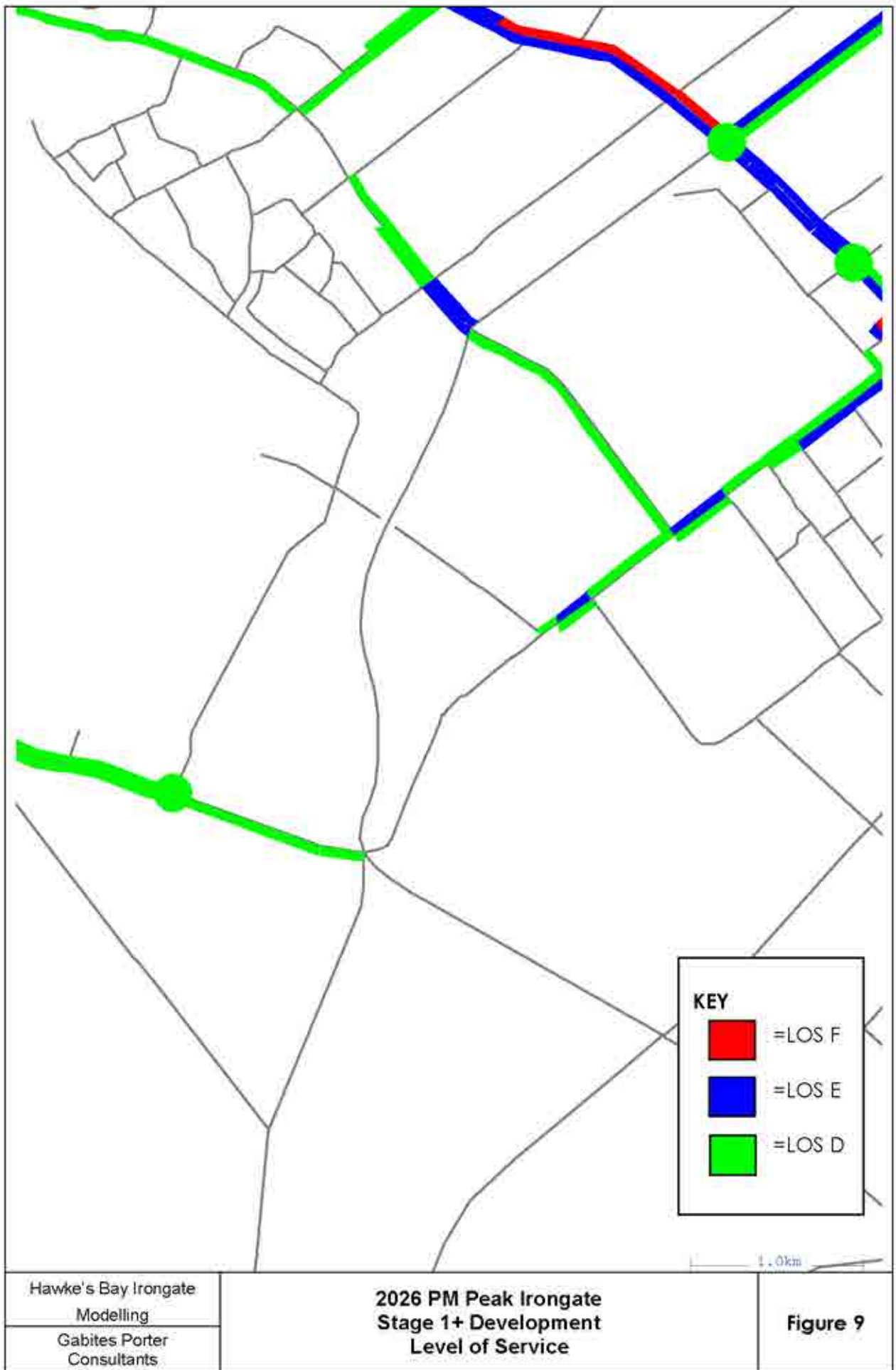

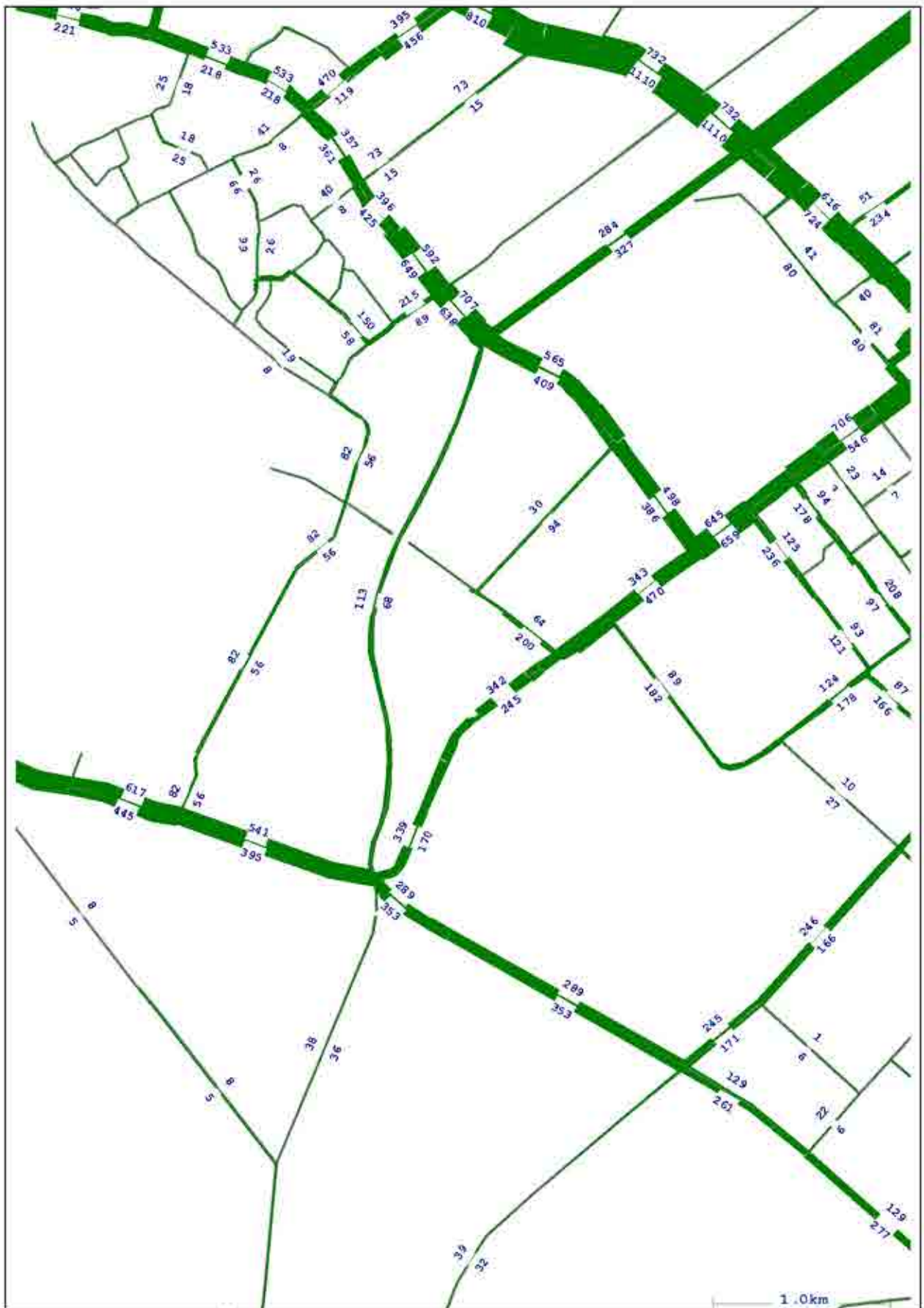

Hawke's Bay Irongate Modelling	2026 AM Peak Irongate with Link Road Stage 1+ Development Traffic Volumes	Figure 10
Gabites Porter Consultants		

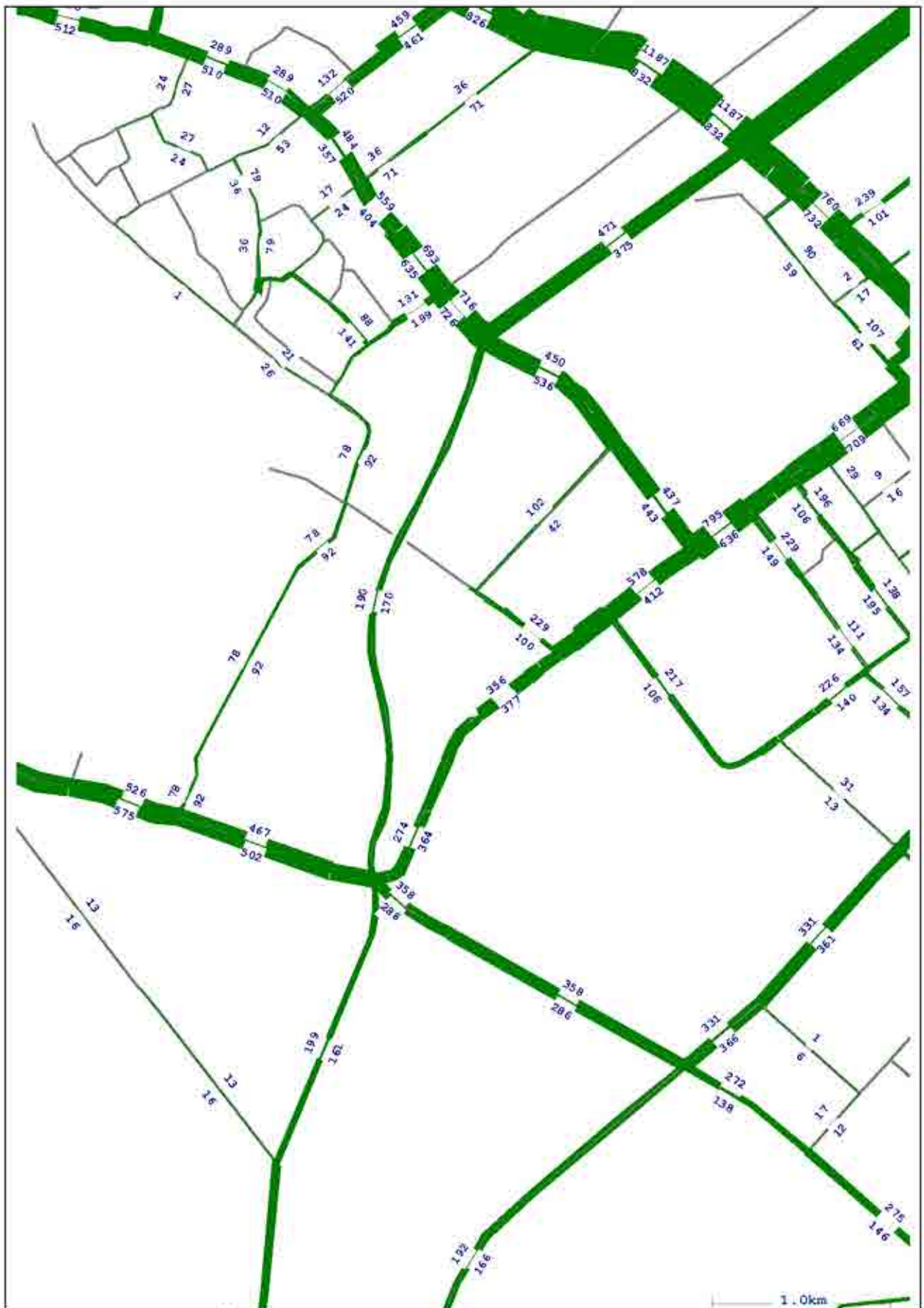

Hawke's Bay Irongate Modelling Gabites Porter Consultants	2026 PM Peak Irongate with Link Road Stage 1+ Development Traffic Volumes	Figure 12
--	--	------------------

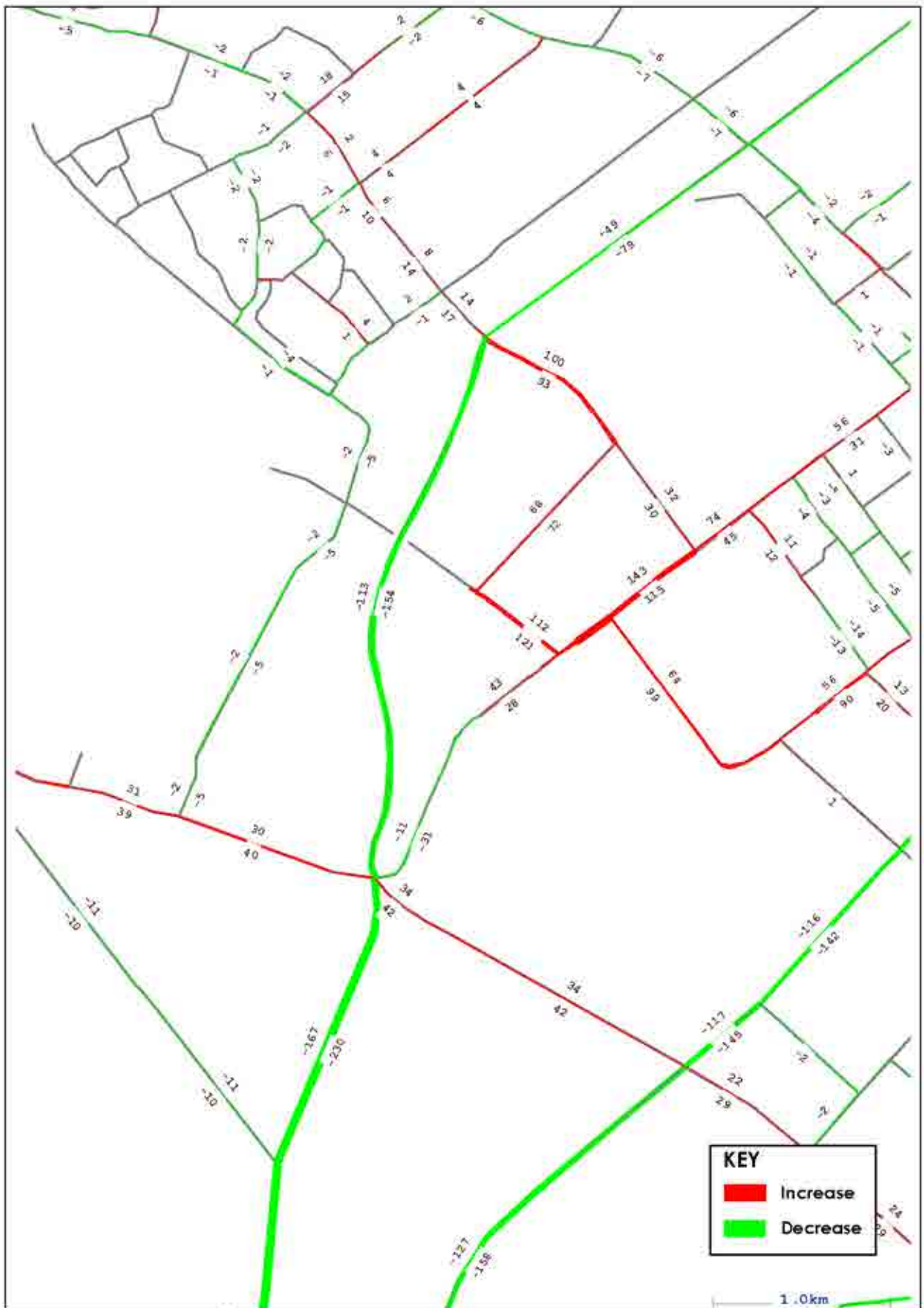

Hawke's Bay Irongate Modelling	2026 SH Peak Irongate with Link Road Stage 1+ Development Change in Traffic Volumes to 2026 Base	Figure 14
Gabites Porter Consultants		

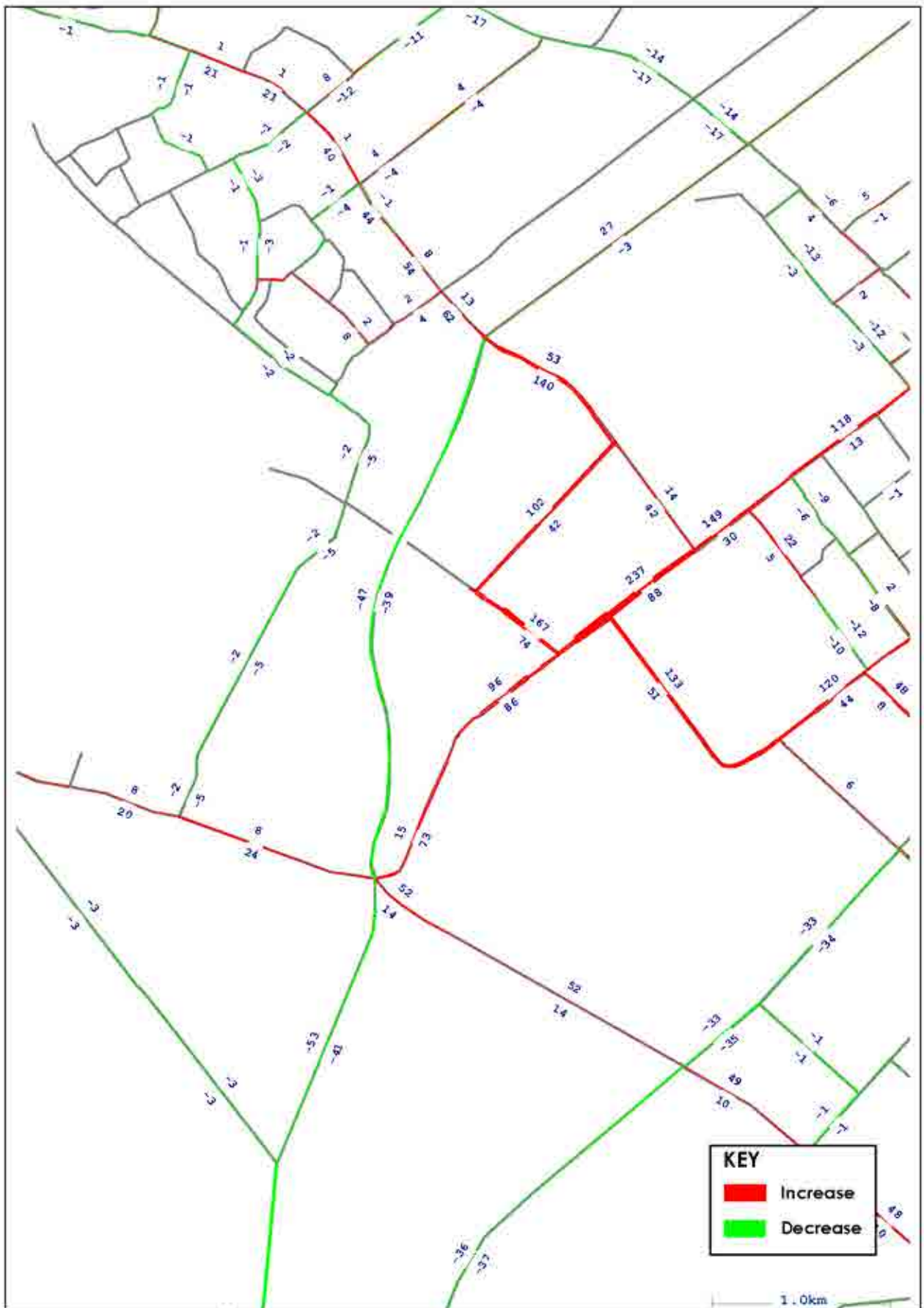

Hawke's Bay Irongate Modelling Gabites Porter Consultants	2026 PM Peak Irongate with Link Road Stage 1+ Development Change in Traffic Volumes to 2026 Base	Figure 15
--	---	------------------

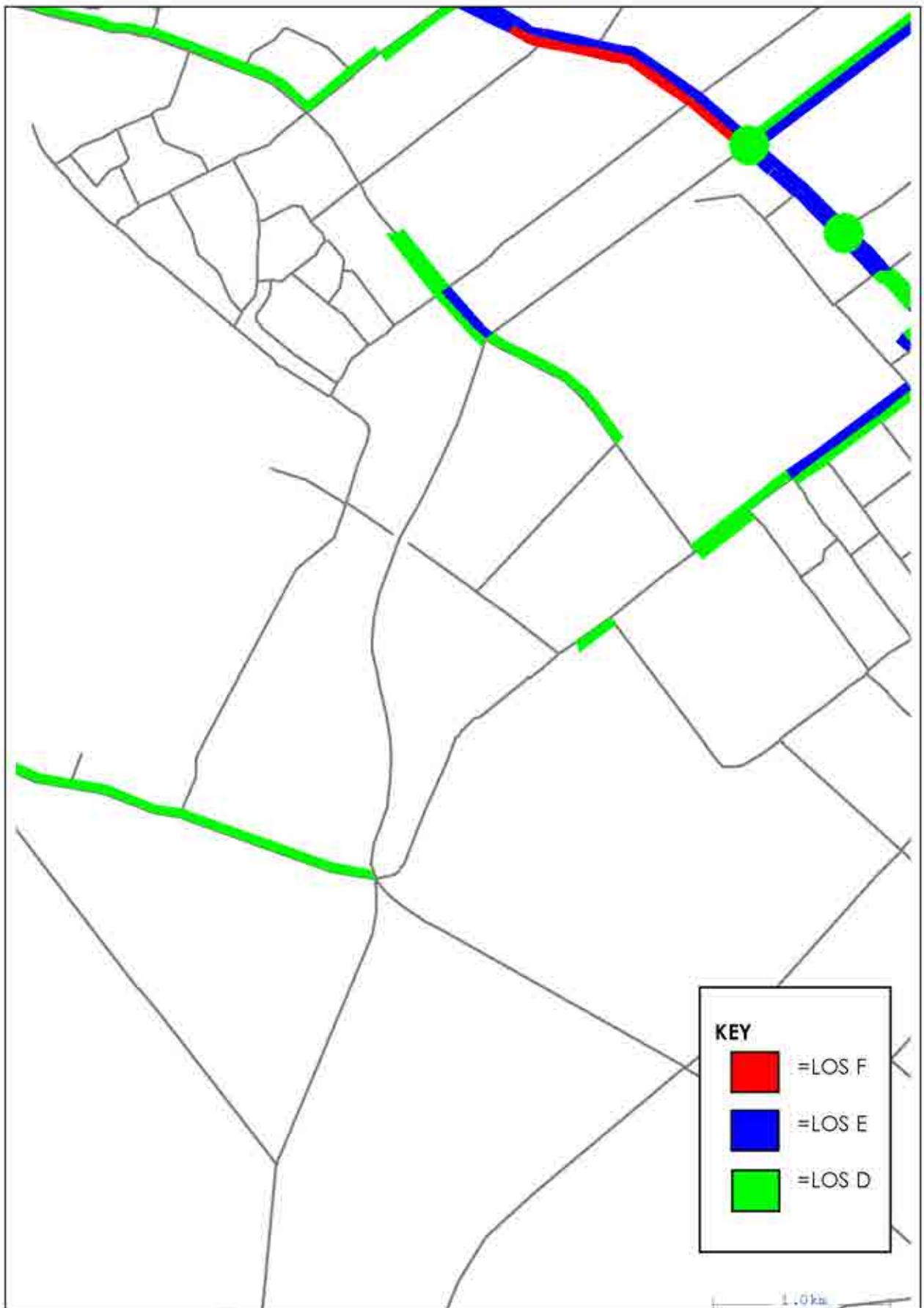

Hawke's Bay Irongate Modelling Gabites Porter Consultants	2026 AM Peak Irongate with Link Road Stage 1+ Development Level of Service	Figure 16
--	---	------------------



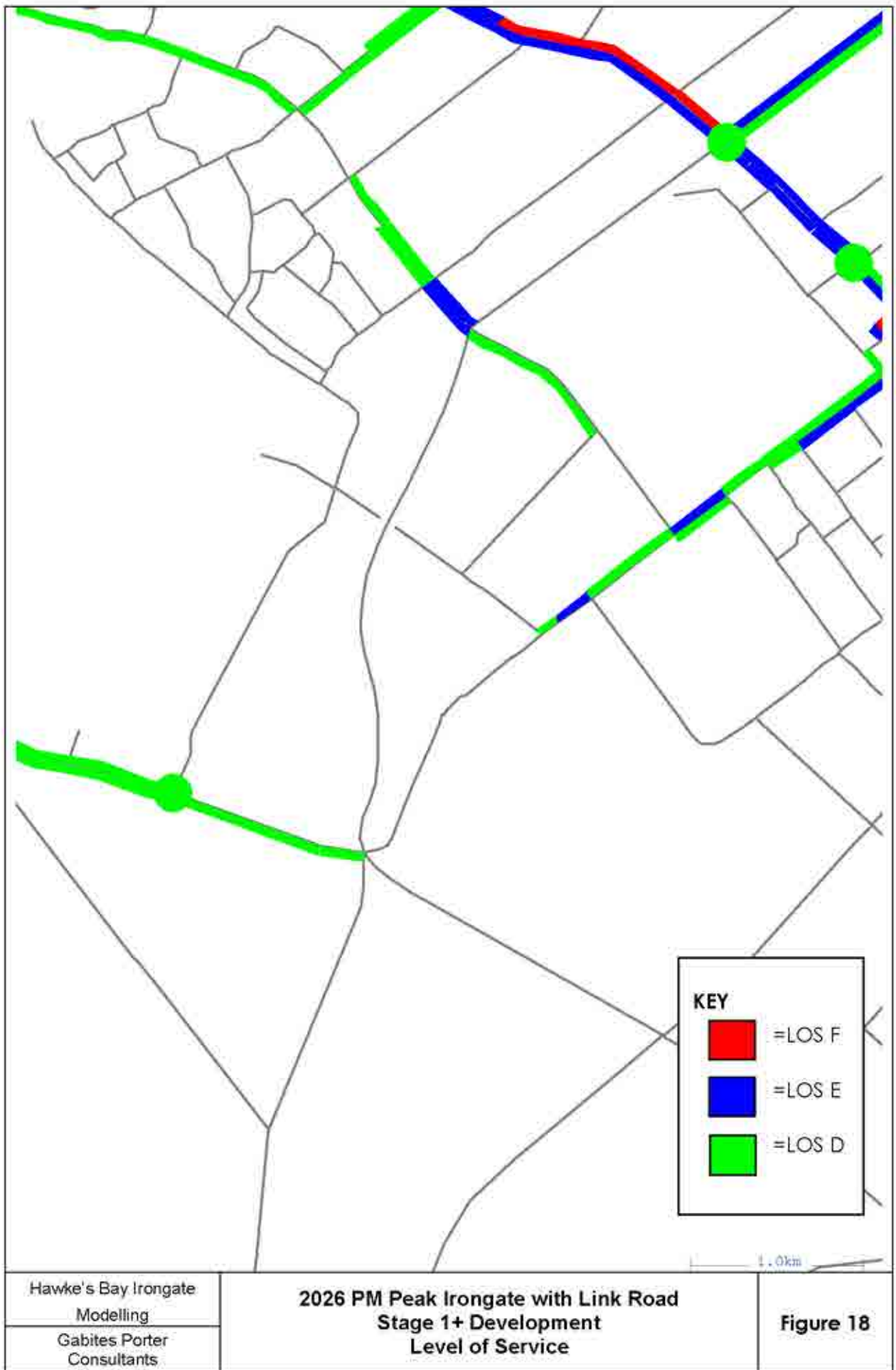

APPENDIX 10

2026 Stage 2:

- With Irongate Development
- With Irongate + York Rd Link with Irongate Rd
- With Irongate + Left turn off expressway into Irongate Rd

1. 2026 AM Peak Irongate Stage 2 Development Traffic Volumes	1
2. 2026 SH Peak Irongate Stage 2 Development Traffic Volumes	2
3. 2026 PM Peak Irongate Stage 2 Development Traffic Volumes	3
4. 2026 AM Peak Irongate Stage 2 Development Change in Traffic Volumes to 2026 Base	4
5. 2026 SH Peak Irongate Stage 2 Development Change in Traffic Volumes to 2026 Base	5
6. 2026 PM Peak Irongate Stage 2 Development Change in Traffic Volumes to 2026 Base	6
7. 2026 AM Peak Irongate Stage 2 Development Level of Service	7
8. 2026 SH Peak Irongate Stage 2 Development Level of Service	8
9. 2026 PM Peak Irongate Stage 2 Development Level of Service	9
10. 2026 AM Peak Irongate with Link Road Stage 2 Development Traffic Volumes	10
11. 2026 SH Peak Irongate with Link Road Stage 2 Development Traffic Volumes	11
12. 2026 PM Peak Irongate with Link Road Stage 2 Development Traffic Volumes	12
13. 2026 AM Peak Irongate with Link Road Stage 2 Development Change in Traffic Volumes to 2026 Base	13
14. 2026 SH Peak Irongate with Link Road Stage 2 Development Change in Traffic Volumes to 2026 Base	14
15. 2026 PM Peak Irongate with Link Road Stage 2 Development Change in Traffic Volumes to 2026 Base	15
16. 2026 AM Peak Irongate with Link Road Stage 2 Development Level of Service	16
17. 2026 SH Peak Irongate with Link Road Stage 2 Development Level of Service	17
18. 2026 PM Peak Irongate with Link Road Stage 2 Development Level of Service	18

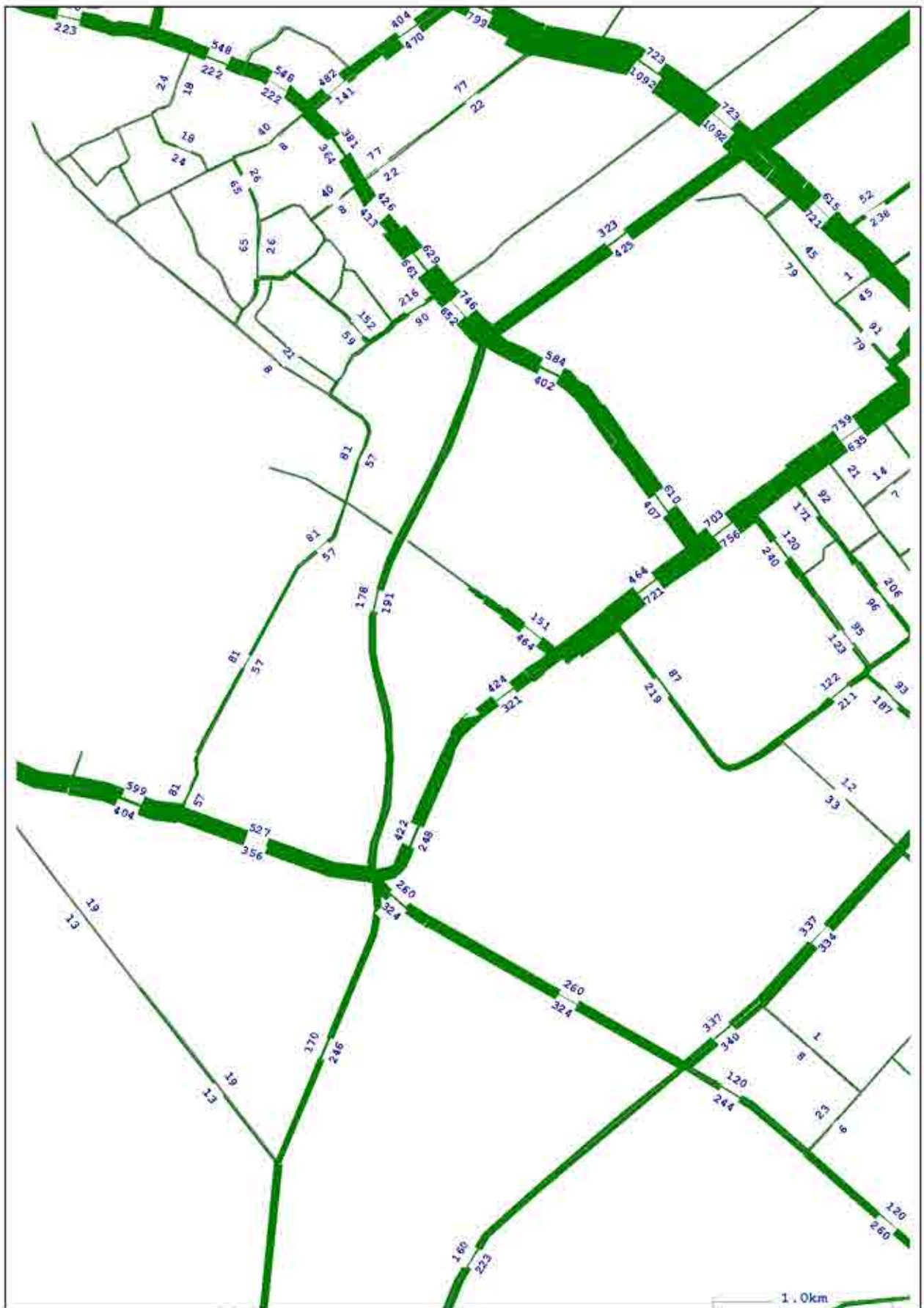

Hawke's Bay Irongate Modelling	2026 AM Peak Irongate Stage 2 Development Traffic Volumes	Figure 1
Gabites Porter Consultants		

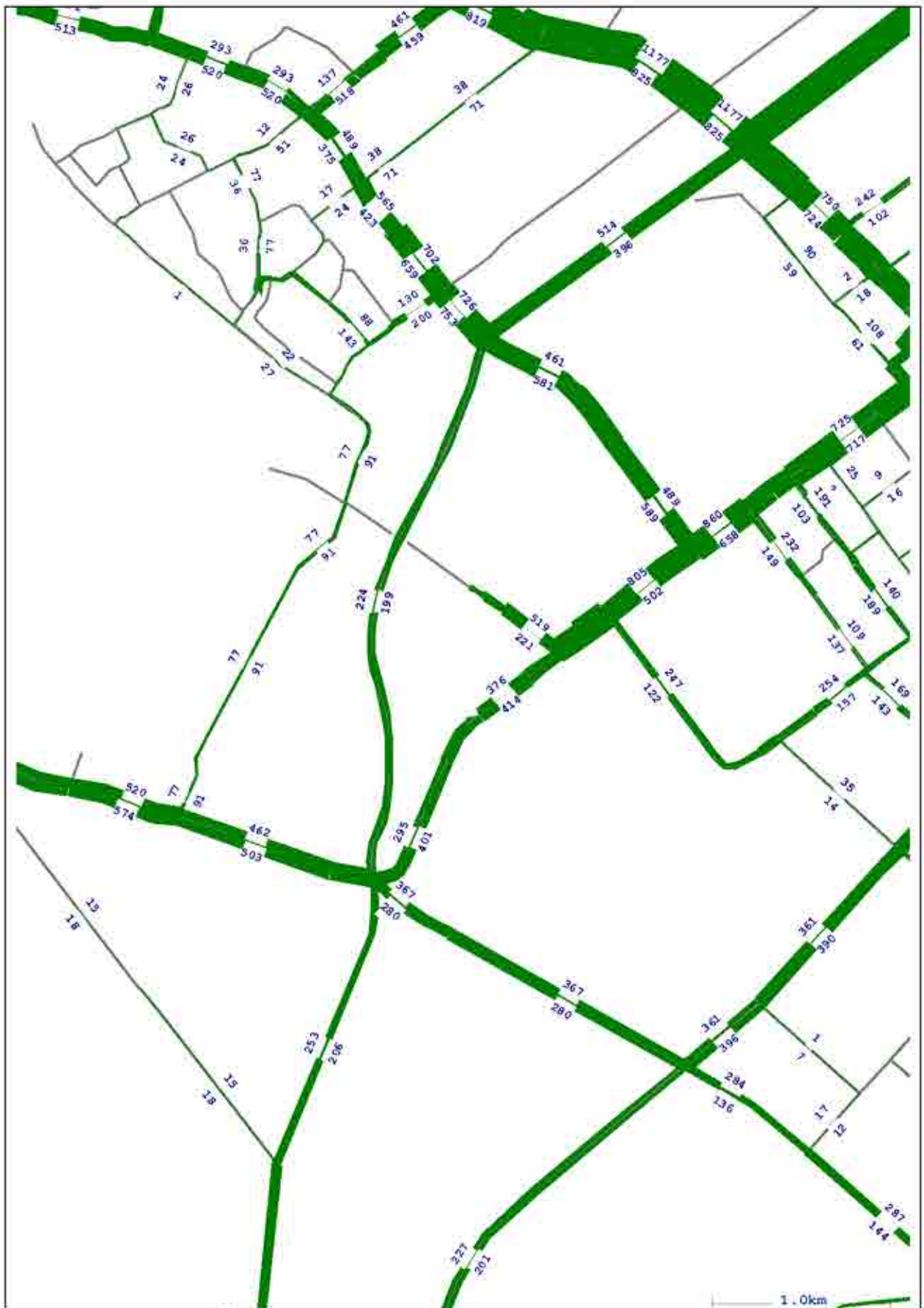

Hawke's Bay Irongate Modelling	2026 PM Peak Irongate Stage 2 Development Traffic Volumes	Figure 3
Gabites Porter Consultants		

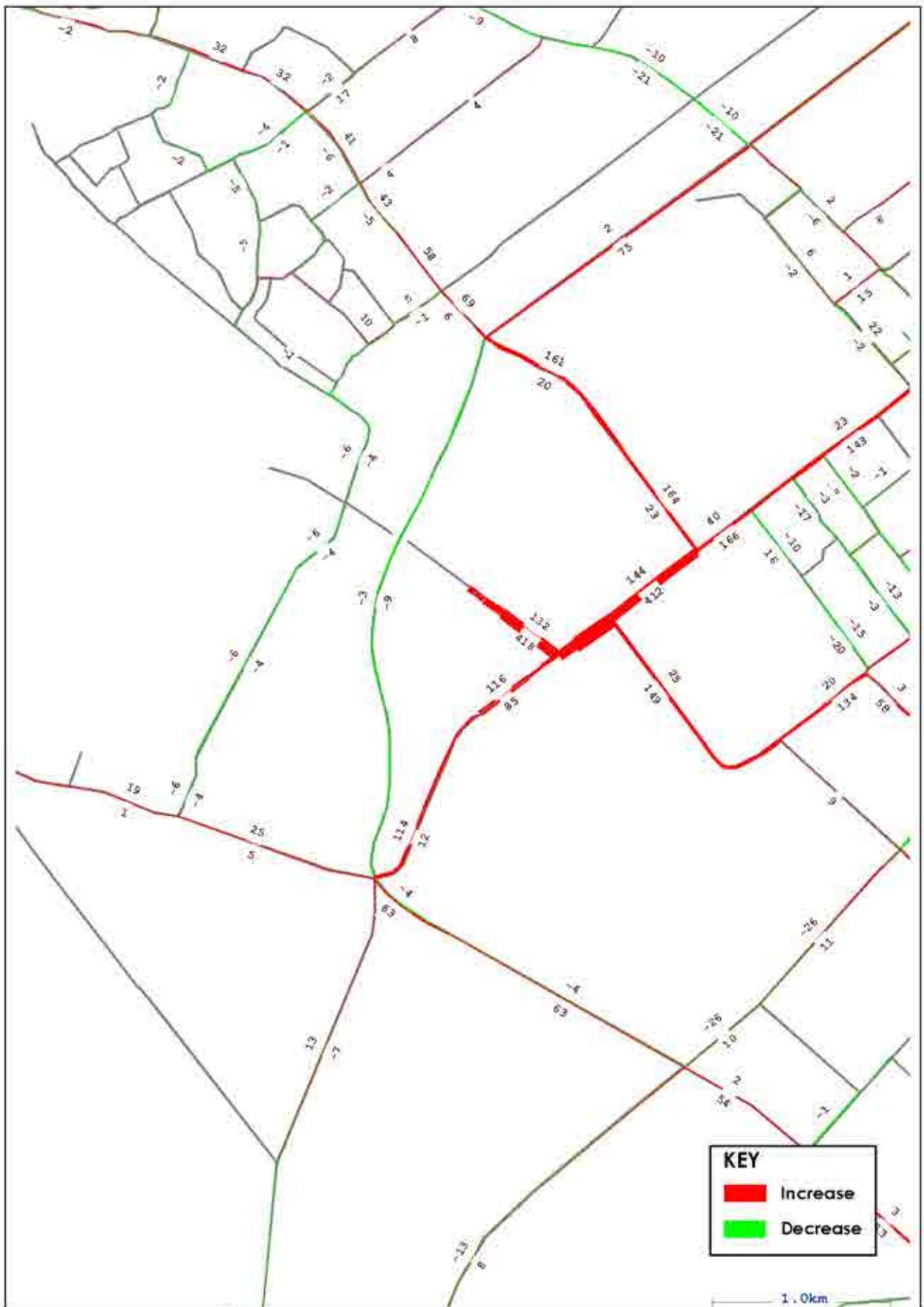

Hawke's Bay Irongate Modelling Gabites Porter Consultants	2026 AM Peak Irongate Stage 2 Development Change in Traffic Volumes to 2026 Base	Figure 4
--	---	-----------------

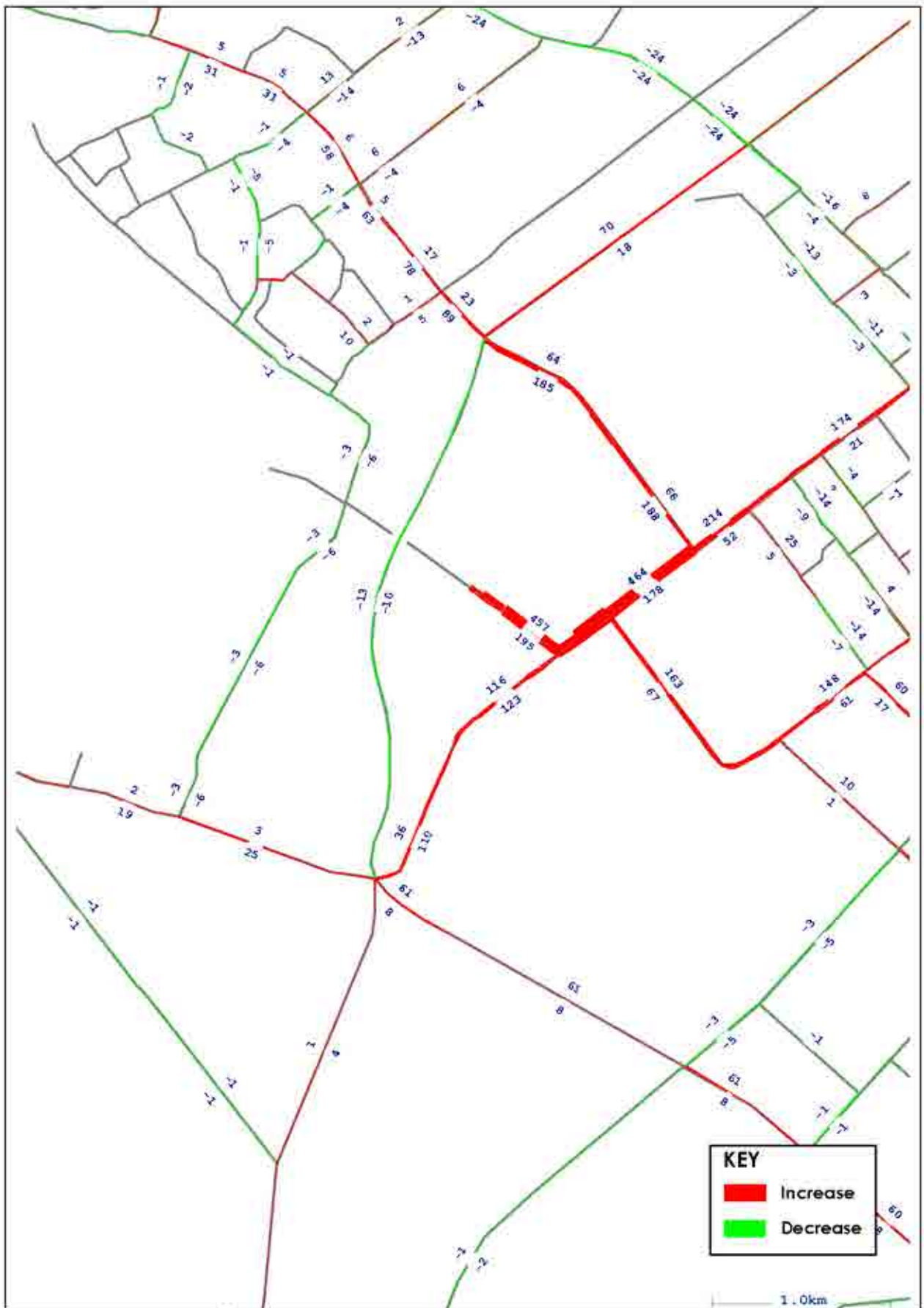

Hawke's Bay Irongate Modelling Gabites Porter Consultants	2026 PM Peak Irongate Stage 2 Development Change in Traffic Volumes to 2026 Base	Figure 6
--	---	-----------------

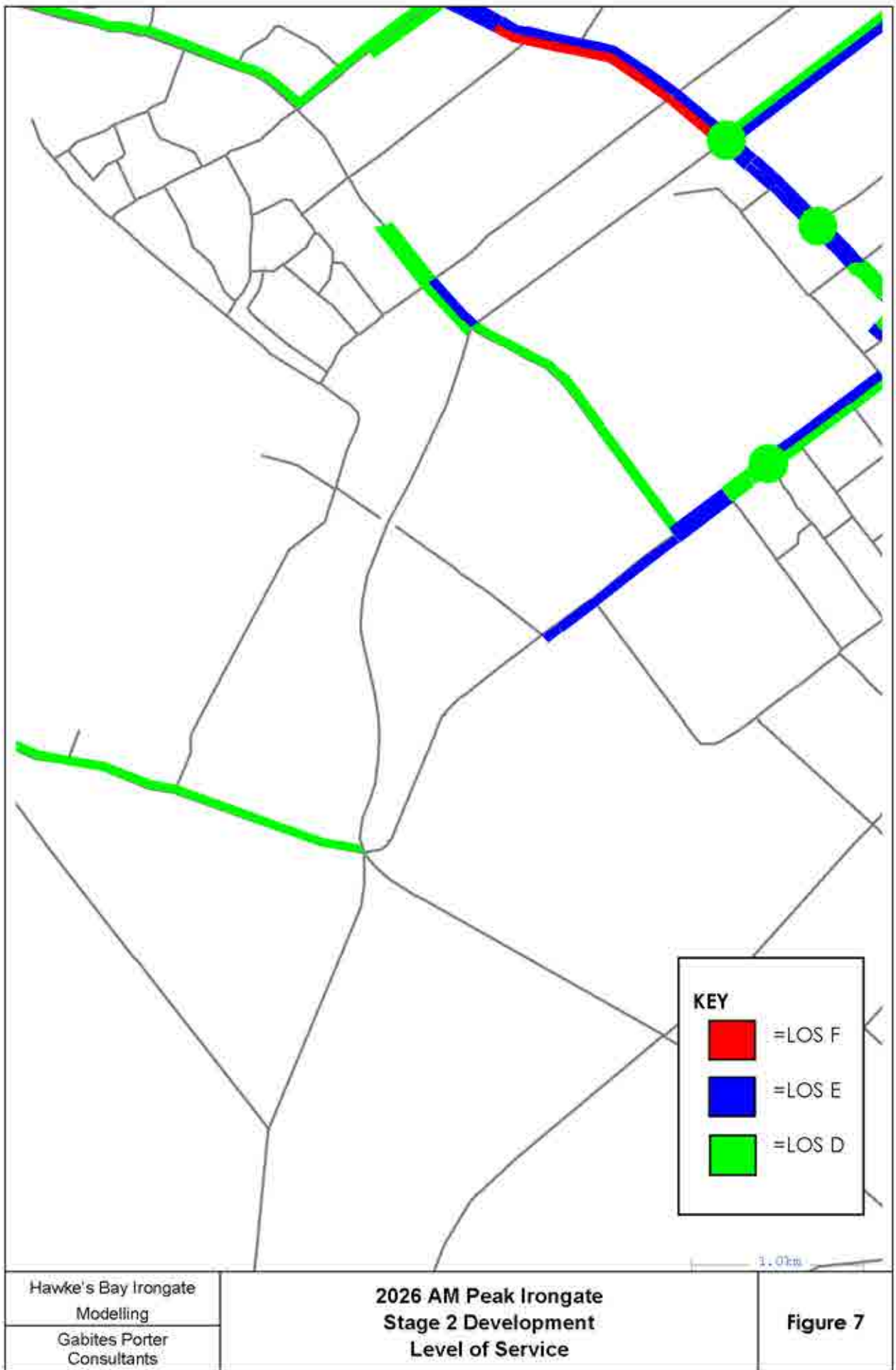

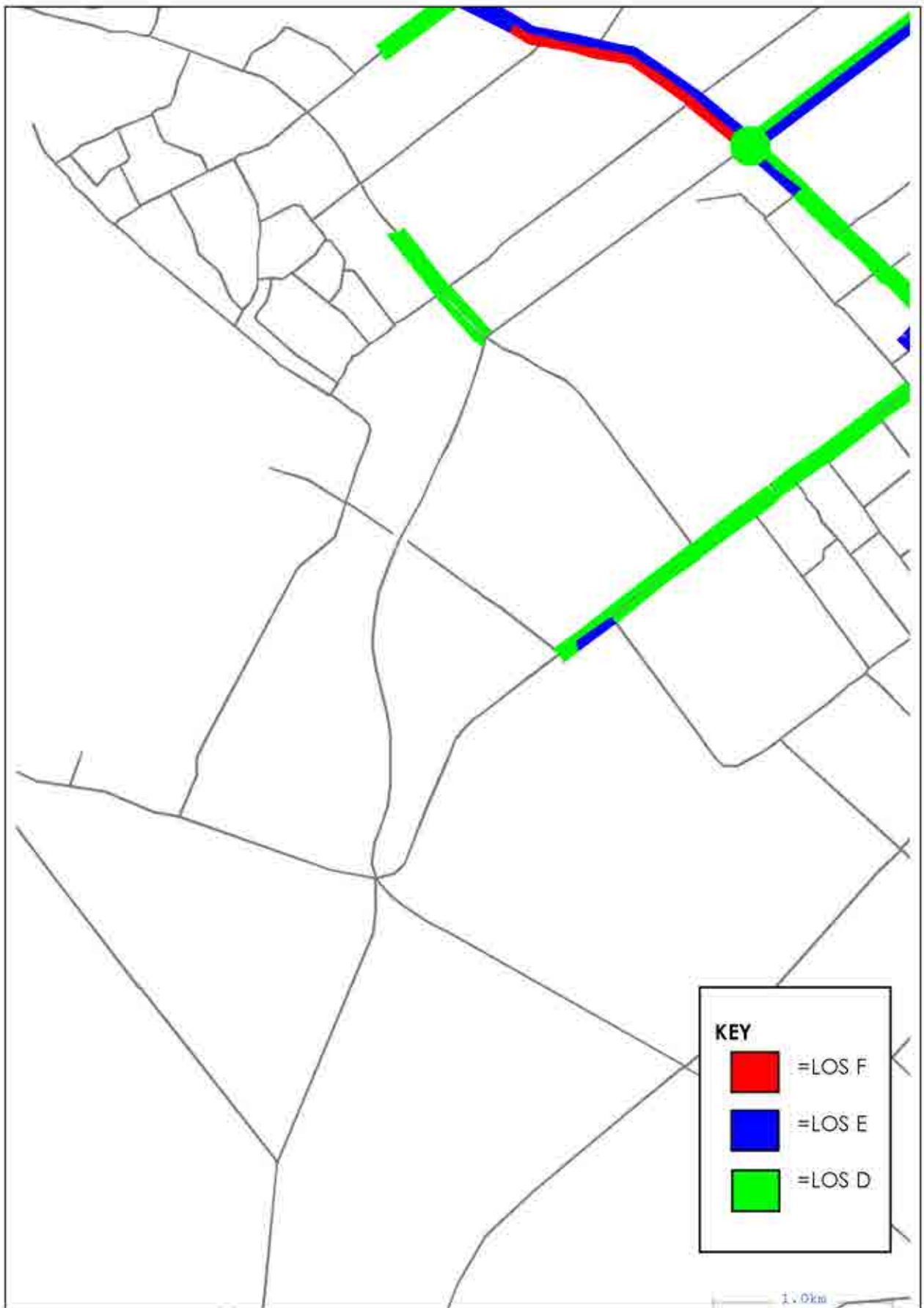

Hawke's Bay Irongate Modelling Gabites Porter Consultants	2026 SH Peak Irongate Stage 2 Development Level of Service	Figure 8
--	---	-----------------

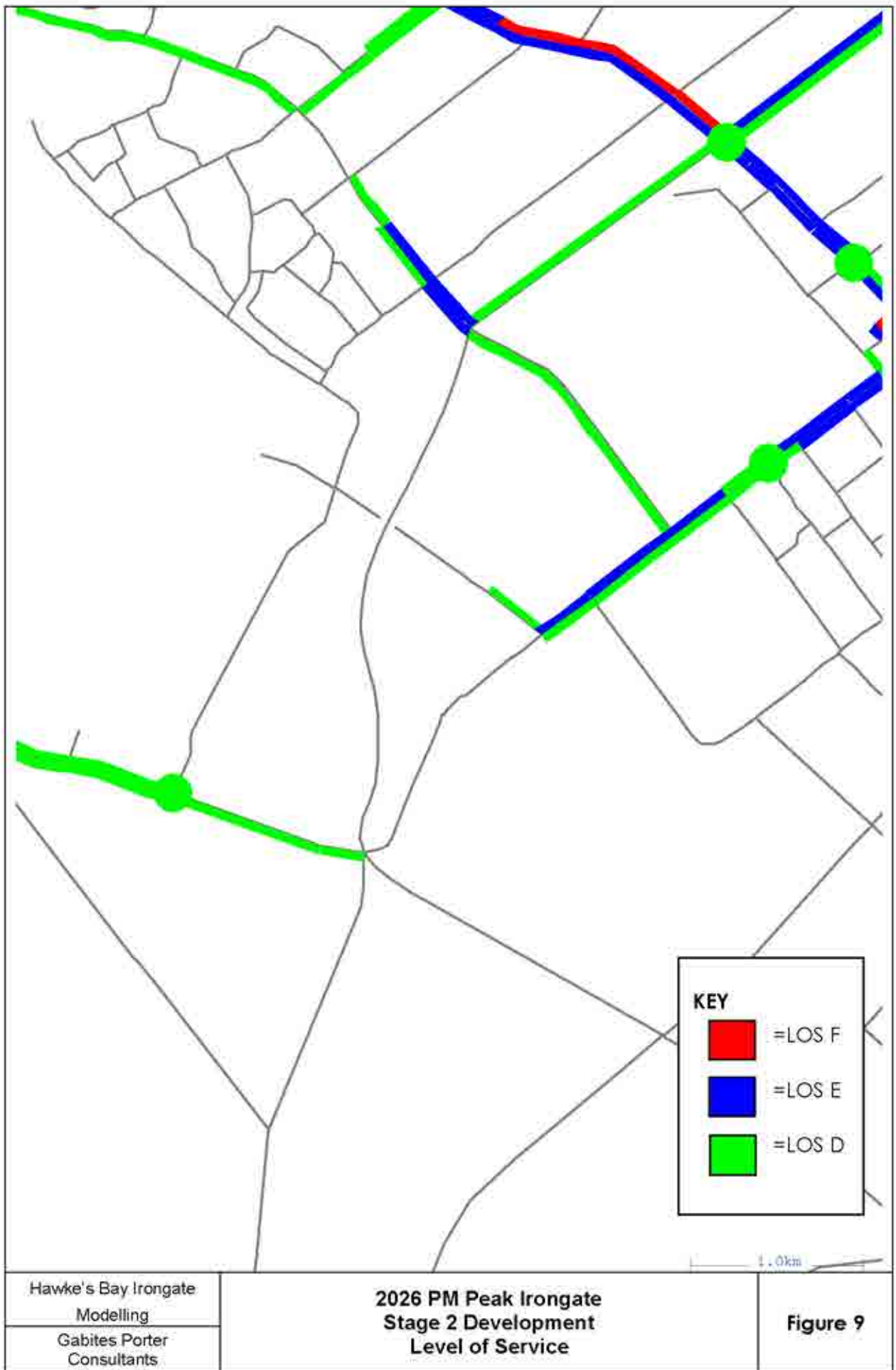

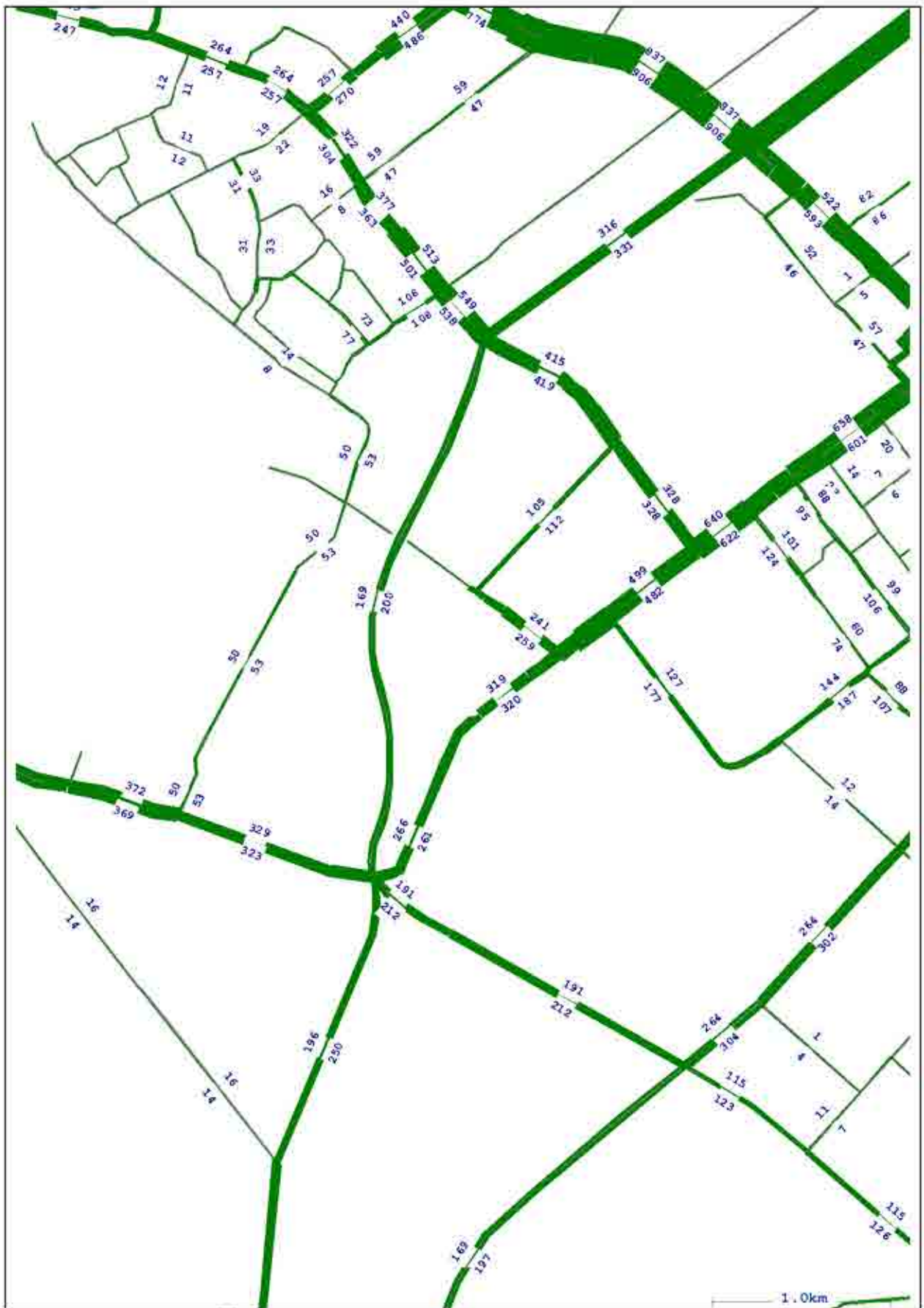

Hawke's Bay Irongate Modelling Gabites Porter Consultants	2026 SH Peak Irongate with Link Road Stage 2 Development Traffic Volumes	Figure 11
--	---	------------------

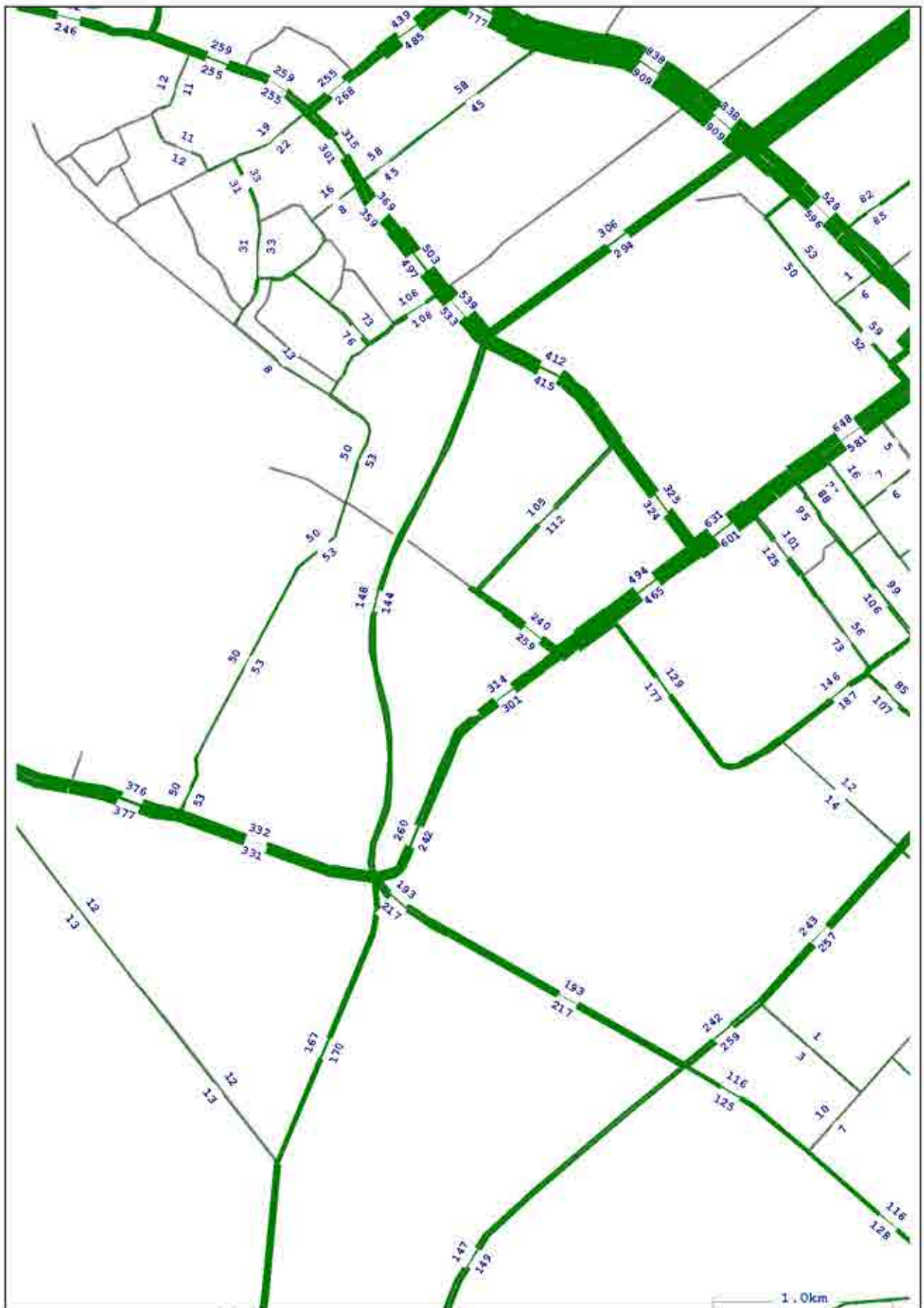

Hawke's Bay Irongate Modelling	2026 PM Peak Irongate with Link Road Stage 2 Development Traffic Volumes	Figure 12
Gabites Porter Consultants		

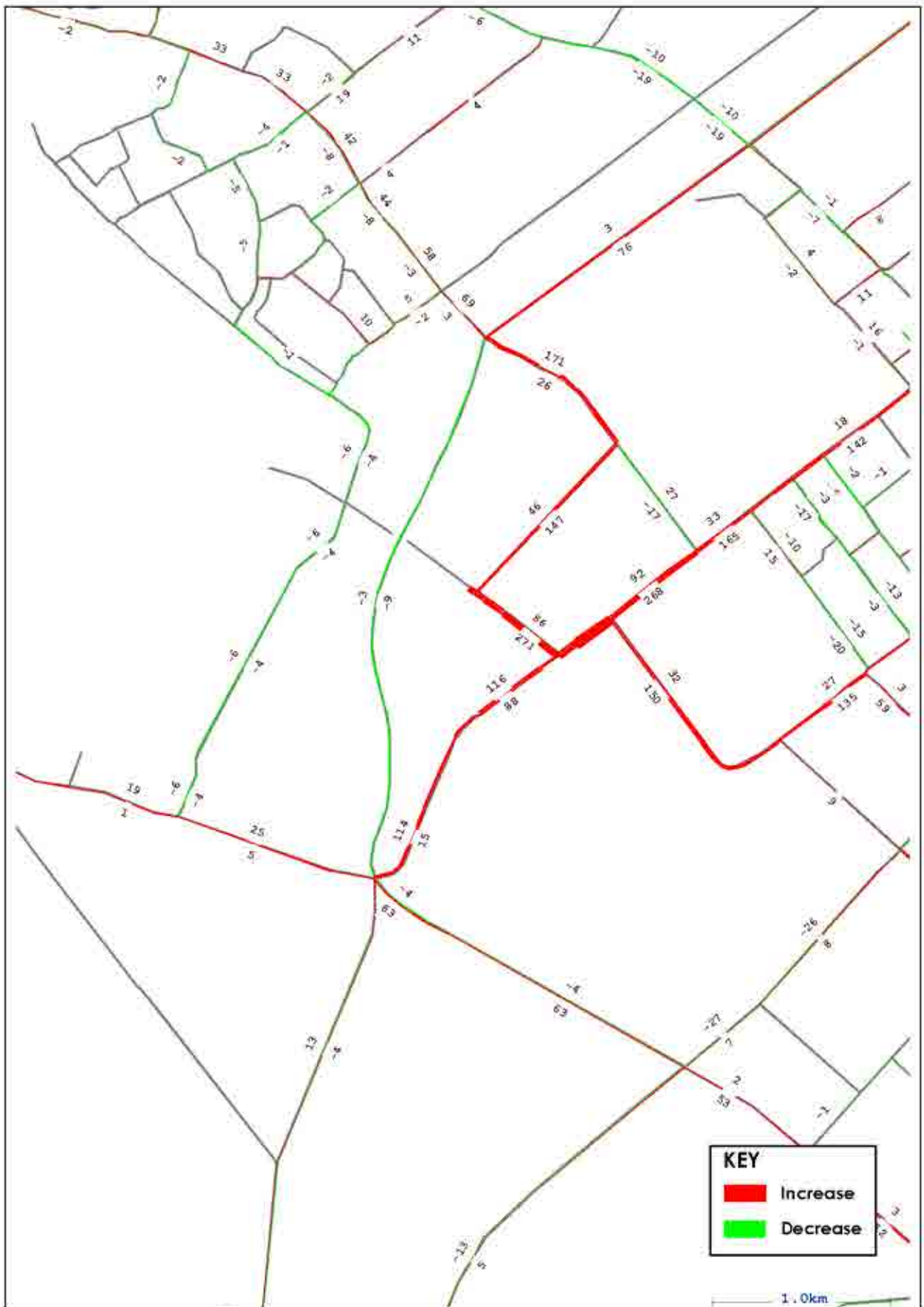

Hawke's Bay Irongate Modelling Gabites Porter Consultants	2026 AM Peak Irongate with Link Road Stage 2 Development Change in Traffic Volumes to 2026 Base	Figure 13
--	--	------------------

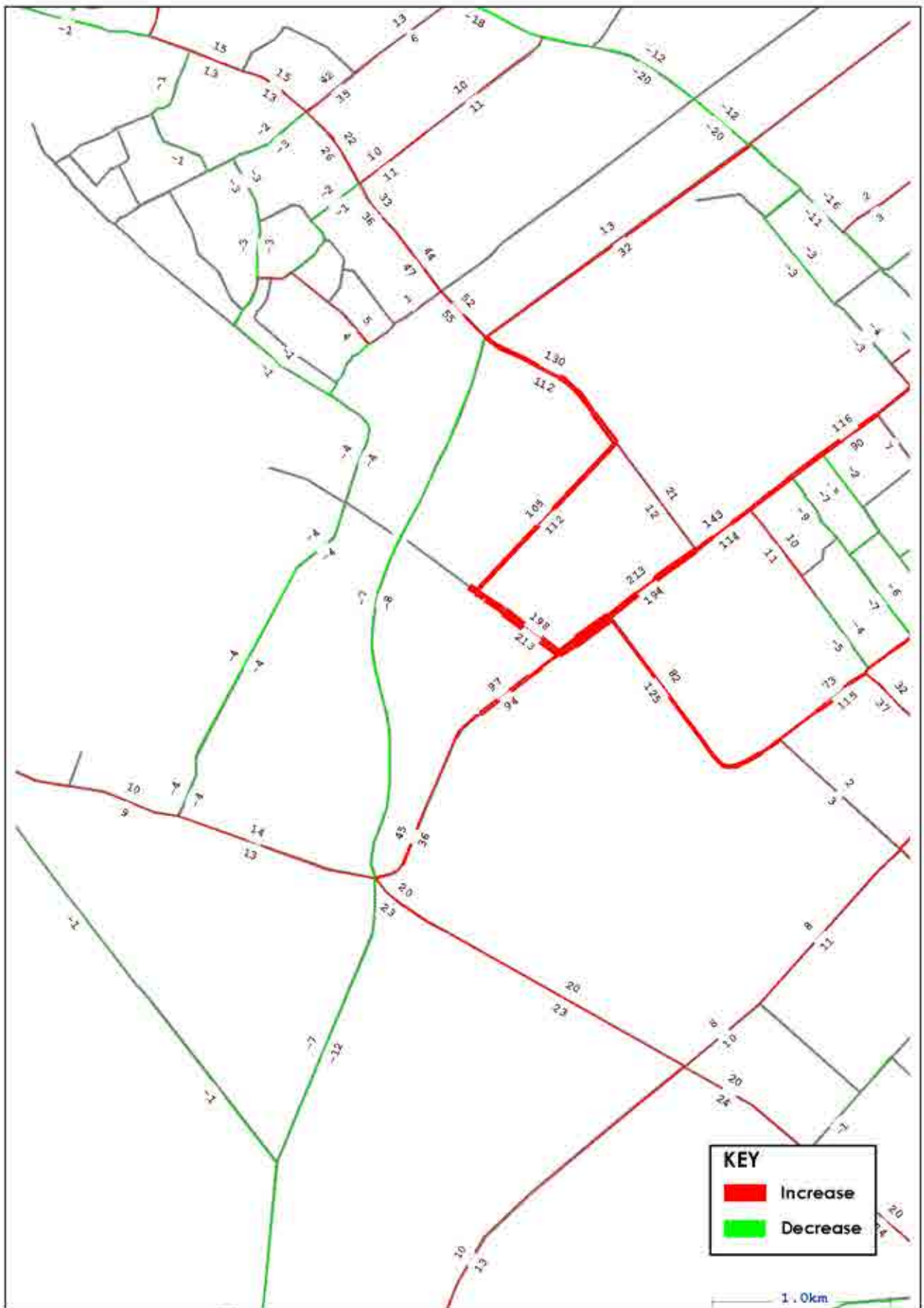

Hawke's Bay Inrrogate Modelling Gabites Porter Consultants	2026 SH Peak Inrrogate with Link Road Stage 2 Development Change in Traffic Volumes to 2026 Base	Figure 14
---	---	------------------

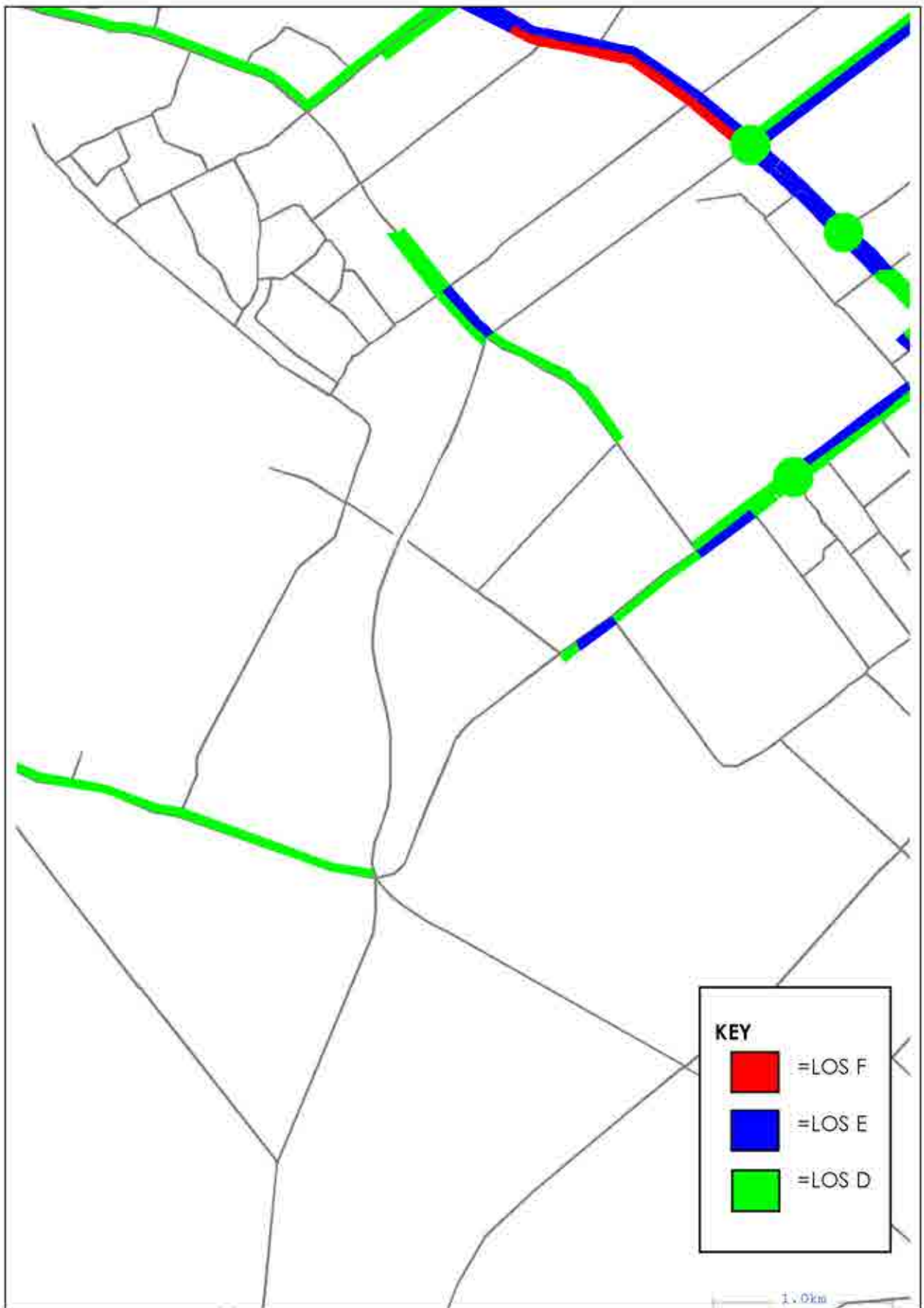

Hawke's Bay Irongate Modelling Gabites Porter Consultants	2026 AM Peak Irongate with Link Road Stage 2 Development Level of Service	Figure 16
--	--	------------------

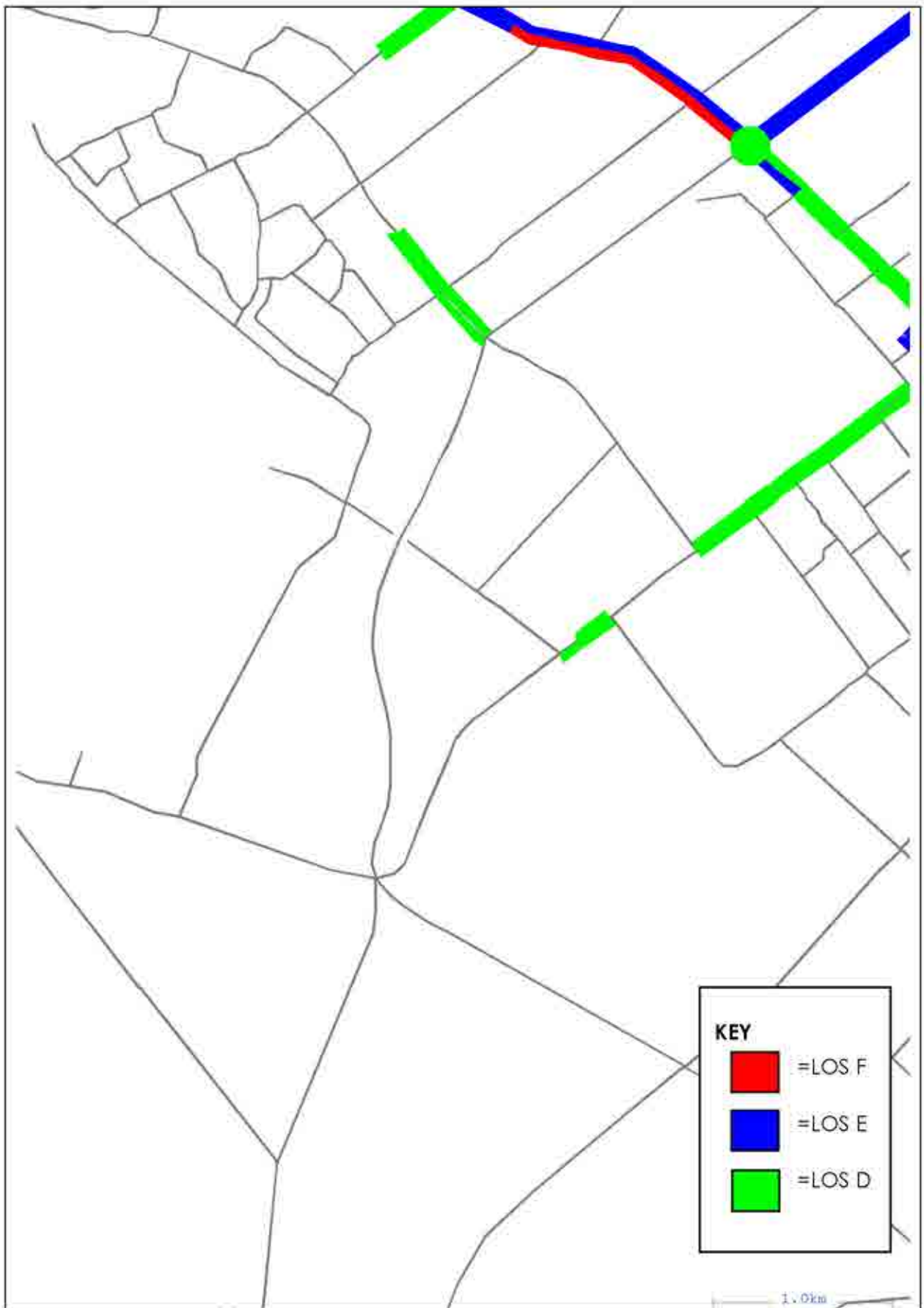

Hawke's Bay Irongate Modelling Gabites Porter Consultants	2026 SH Peak Irongate with Link Road Stage 2 Development Level of Service	Figure 17
--	--	------------------

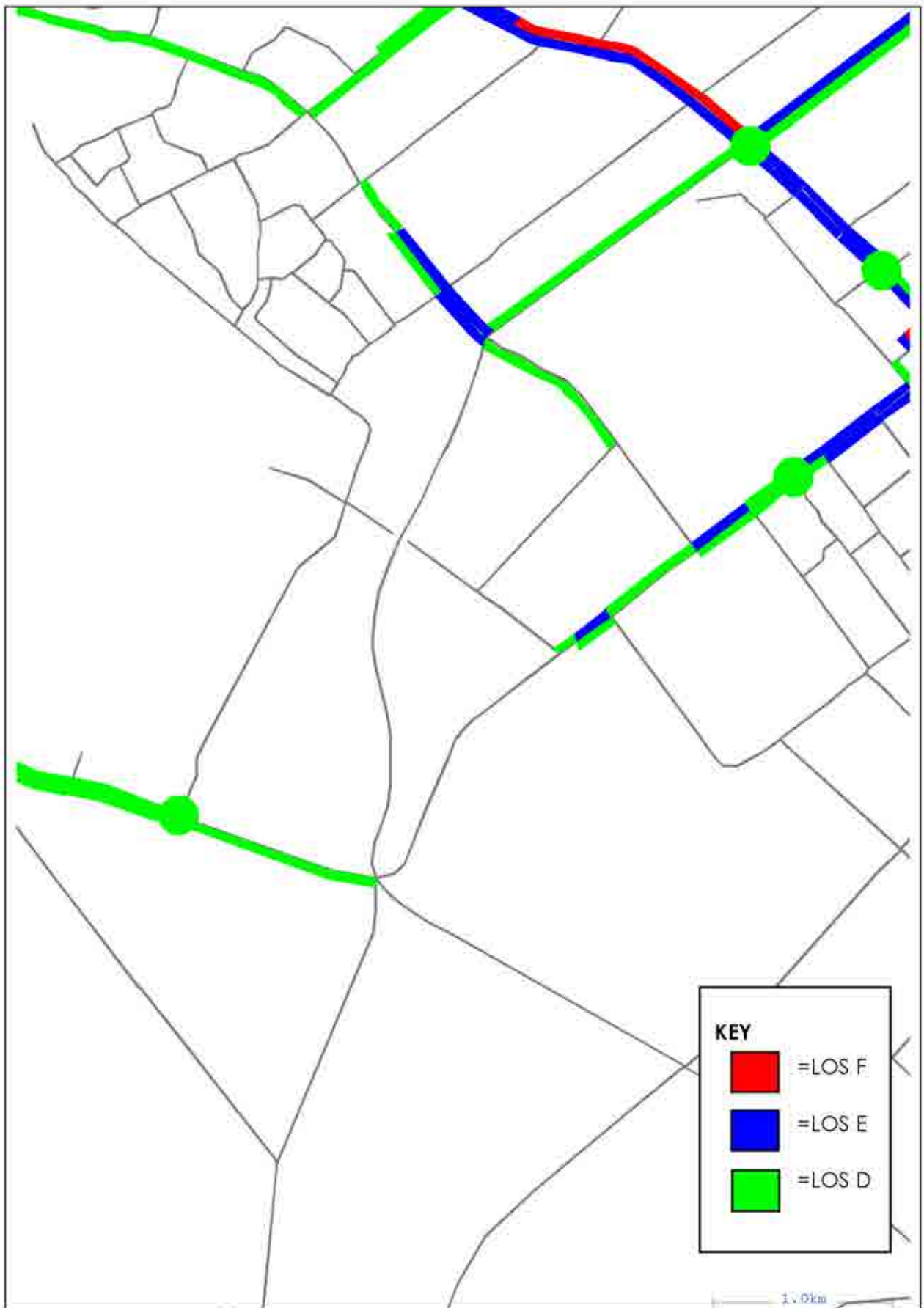

Hawke's Bay Irongate Modelling Gabites Porter Consultants	2026 PM Peak Irongate with Link Road Stage 2 Development Level of Service	Figure 18
--	--	------------------

APPENDIX 11

2026 Stage 2+:

- With Irongate Development
- With Irongate + York Rd Link with Irongate Rd
- With Irongate + Left turn off expressway into Irongate Rd

1. 2026 AM Peak Irongate Stage 2+ Development Traffic Volumes	1
2. 2026 SH Peak Irongate Stage 2+ Development Traffic Volumes	2
3. 2026 PM Peak Irongate Stage 2+ Development Traffic Volumes	3
4. 2026 AM Peak Irongate Stage 2+ Development Change in Traffic Volumes to 2026 Base	4
5. 2026 SH Peak Irongate Stage 2+ Development Change in Traffic Volumes to 2026 Base	5
6. 2026 PM Peak Irongate Stage 2+ Development Change in Traffic Volumes to 2026 Base	6
7. 2026 AM Peak Irongate Stage 2+ Development Level of Service	7
8. 2026 SH Peak Irongate Stage 2+ Development Level of Service	8
9. 2026 PM Peak Irongate Stage 2+ Development Level of Service	9
10. 2026 AM Peak Irongate with Link Road Stage 2+ Development Traffic Volumes	10
11. 2026 SH Peak Irongate with Link Road Stage 2+ Development Traffic Volumes	11
12. 2026 PM Peak Irongate with Link Road Stage 2+ Development Traffic Volumes	12
13. 2026 AM Peak Irongate with Link Road Stage 2+ Development Change in Traffic Volumes to 2026 Base	13
14. 2026 SH Peak Irongate with Link Road Stage 2+ Development Change in Traffic Volumes to 2026 Base	14
15. 2026 PM Peak Irongate with Link Road Stage 2+ Development Change in Traffic Volumes to 2026 Base	15
16. 2026 AM Peak Irongate with Link Road Stage 2+ Development Level of Service	16
17. 2026 SH Peak Irongate with Link Road Stage 2+ Development Level of Service	17
18. 2026 PM Peak Irongate with Link Road Stage 2+ Development Level of Service	18

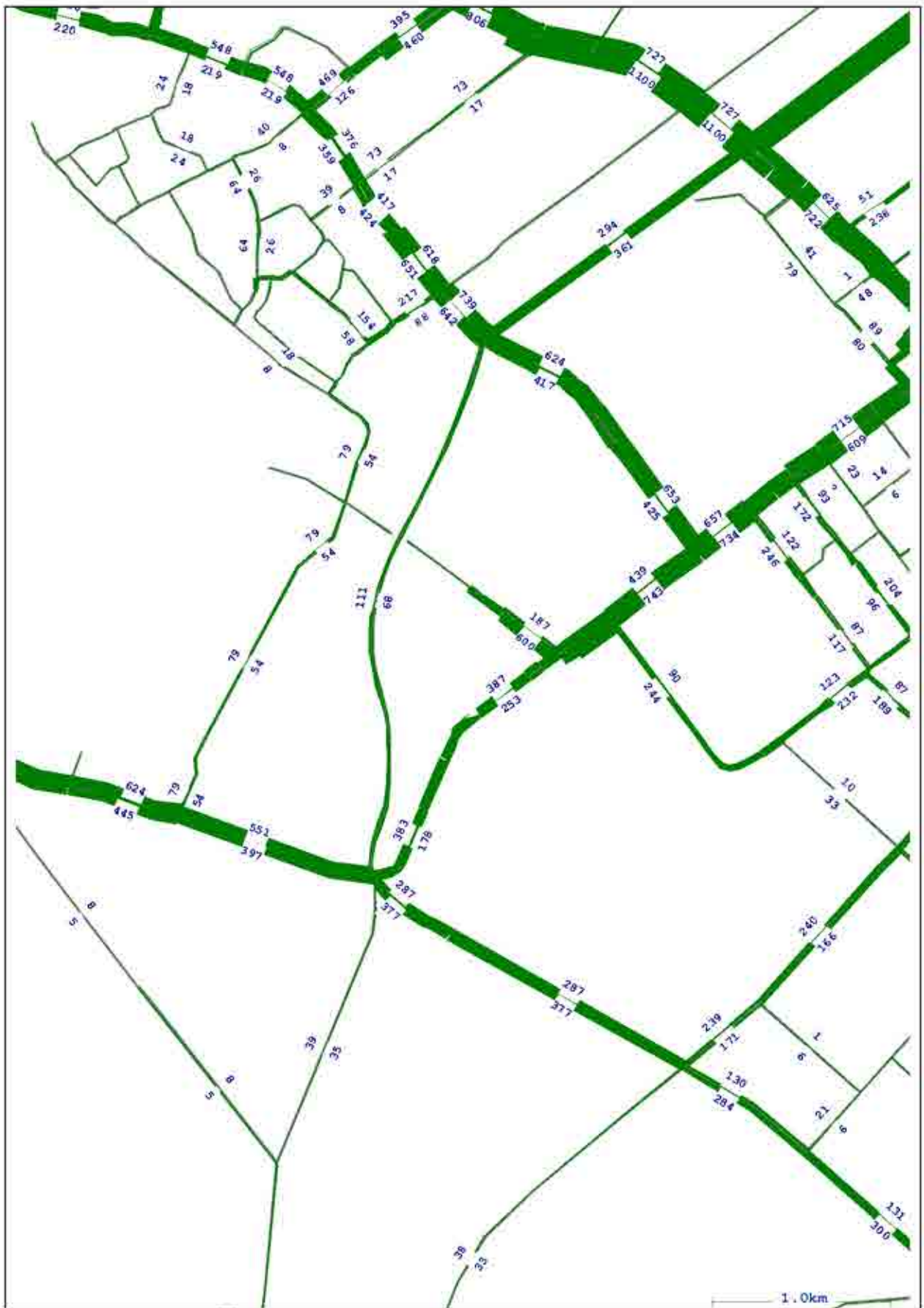

Hawke's Bay Irongate Modelling	2026 AM Peak Irongate Stage 2+ Development Traffic Volumes	Figure 1
Gabites Porter Consultants		

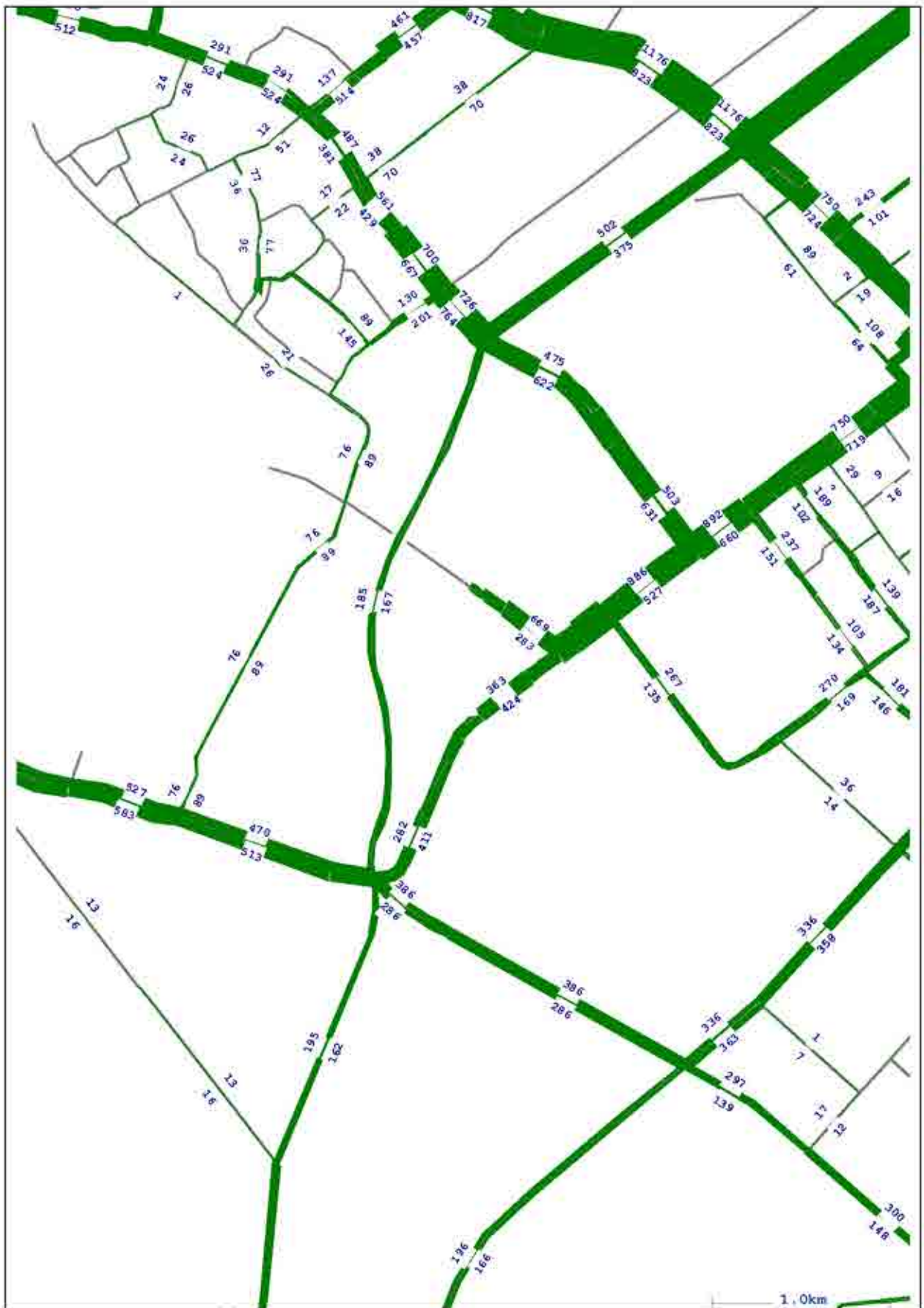

Hawke's Bay Irongate Modelling	2026 PM Peak Irongate Stage 2+ Development Traffic Volumes	Figure 3
Gabites Porter Consultants		

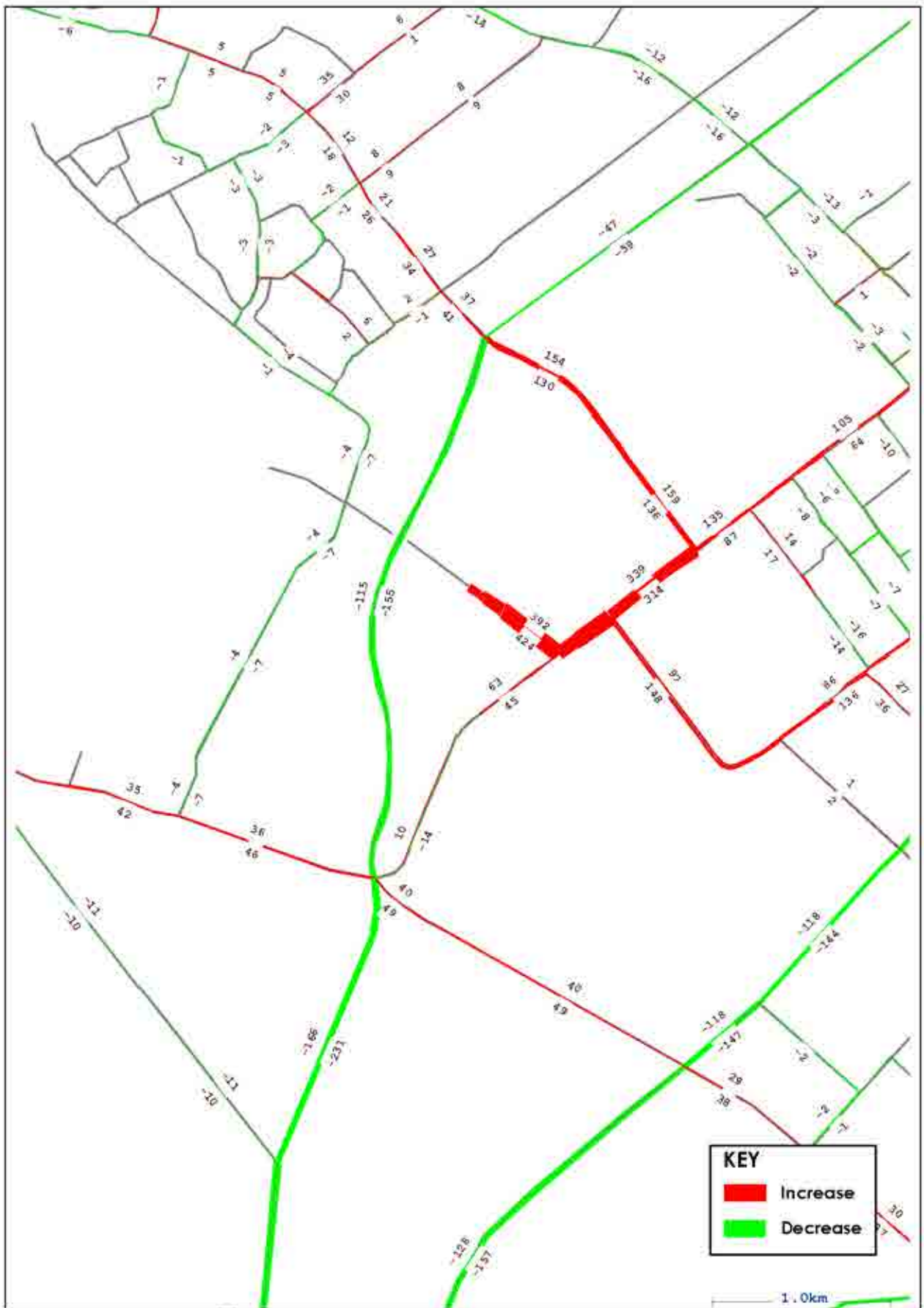

Hawke's Bay Irongate Modelling Gabites Porter Consultants	2026 SH Peak Irongate Stage 2+ Development Change in Traffic Volumes to 2026 Base	Figure 5
--	--	-----------------

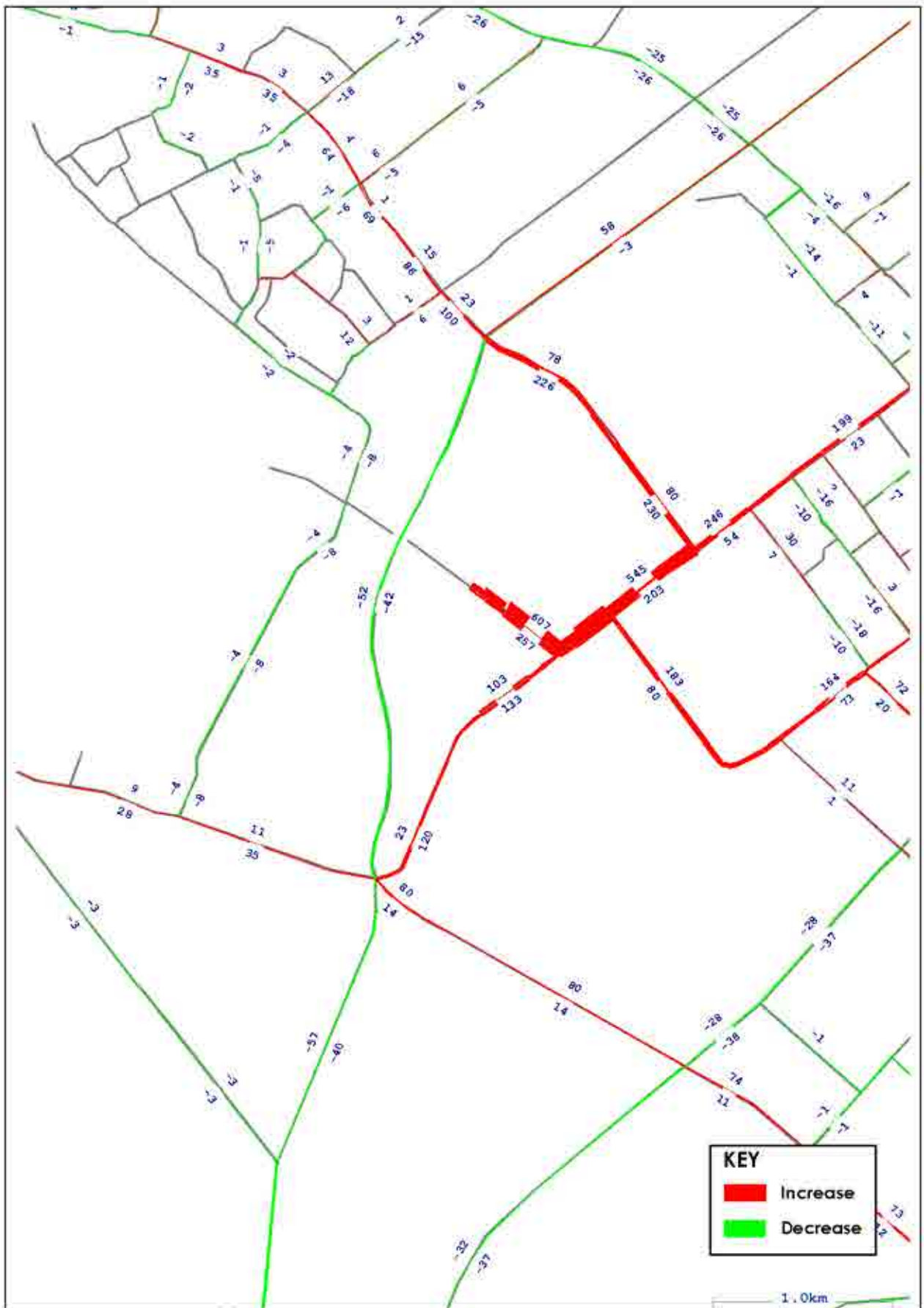

Hawke's Bay Irongate Modelling	2026 PM Peak Irongate Stage 2+ Development Change in Traffic Volumes to 2026 Base	Figure 6
Gabites Porter Consultants		

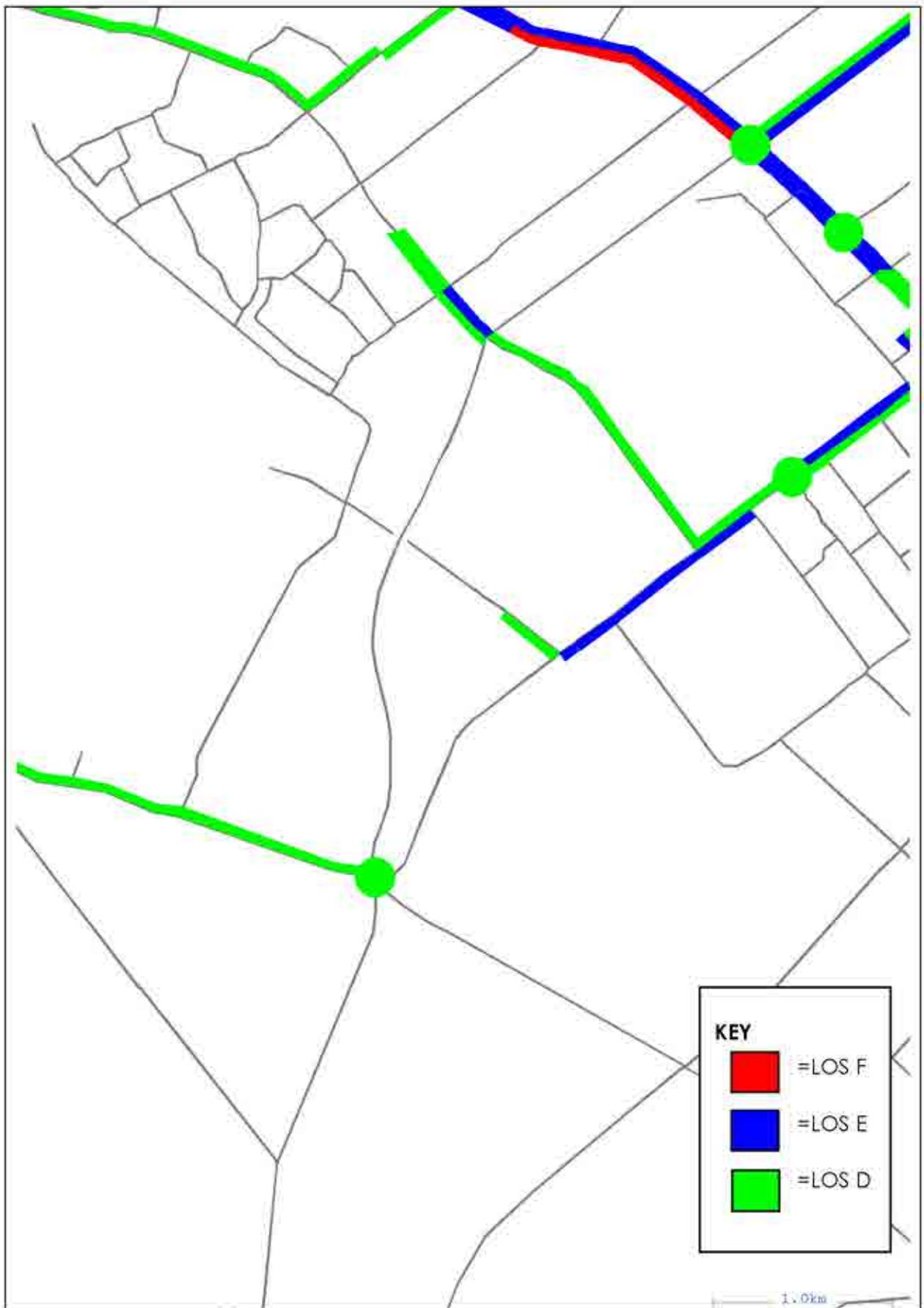

Hawke's Bay Irongate Modelling Gabites Porter Consultants	2026 AM Peak Irongate Stage 2+ Development Level of Service	Figure 7
--	--	-----------------

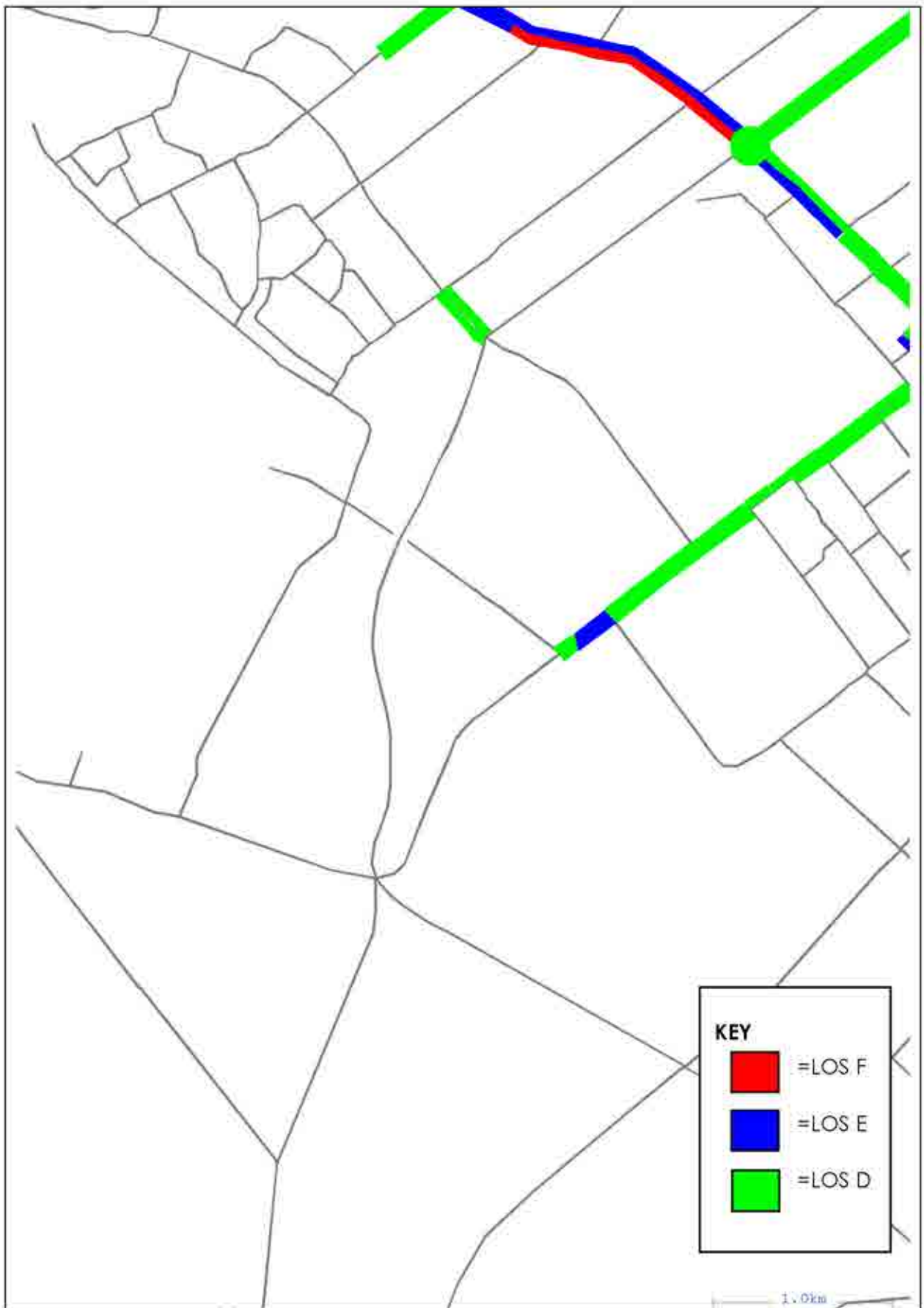

Hawke's Bay Irongate Modelling Gabites Porter Consultants	2026 SH Peak Irongate Stage 2+ Development Level of Service	Figure 8
--	--	-----------------

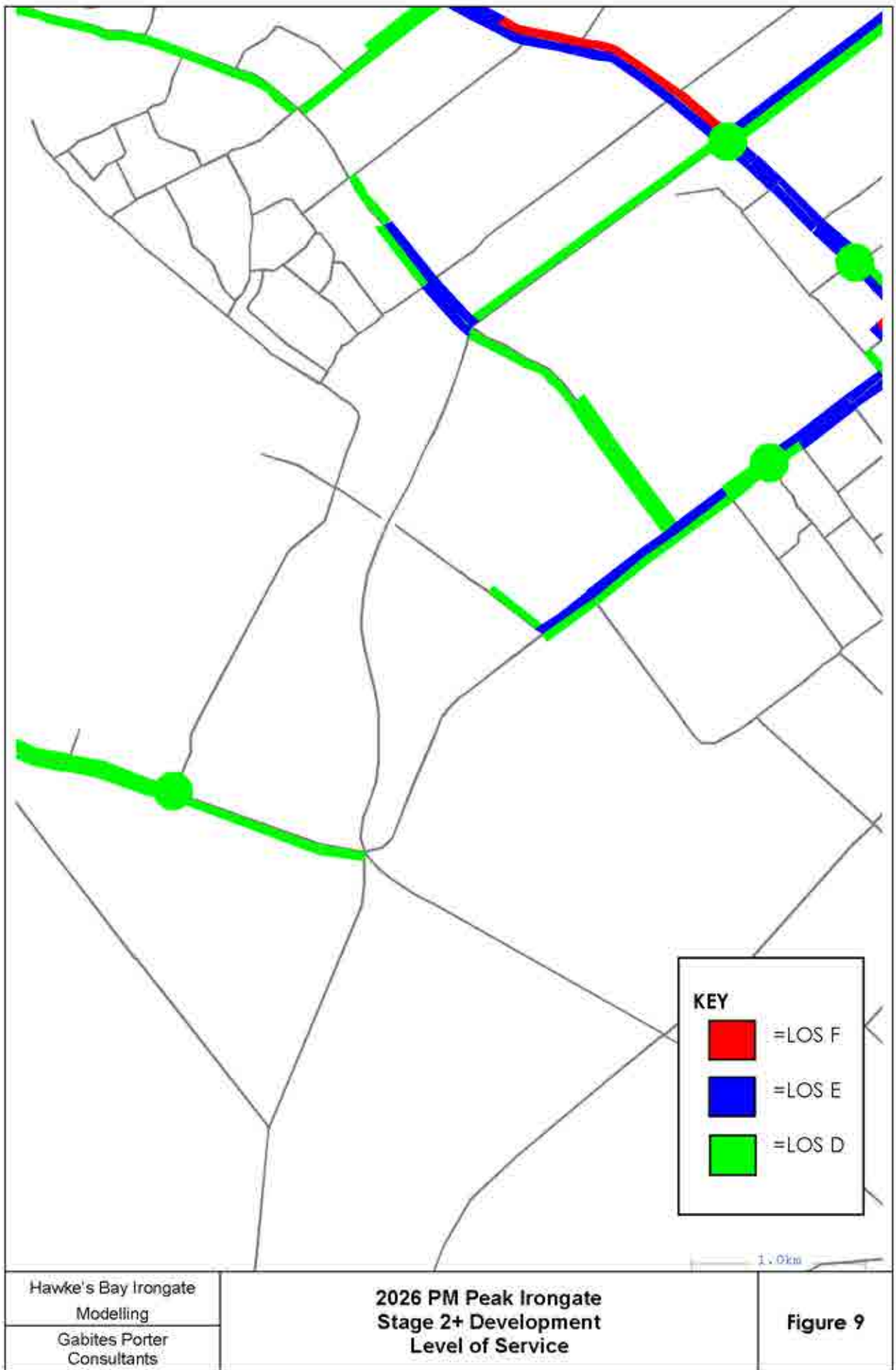



Hawke's Bay Irongate Modelling	2026 AM Peak Irongate with Link Road Stage 2+ Development Traffic Volumes	Figure 10
Gabites Porter Consultants		

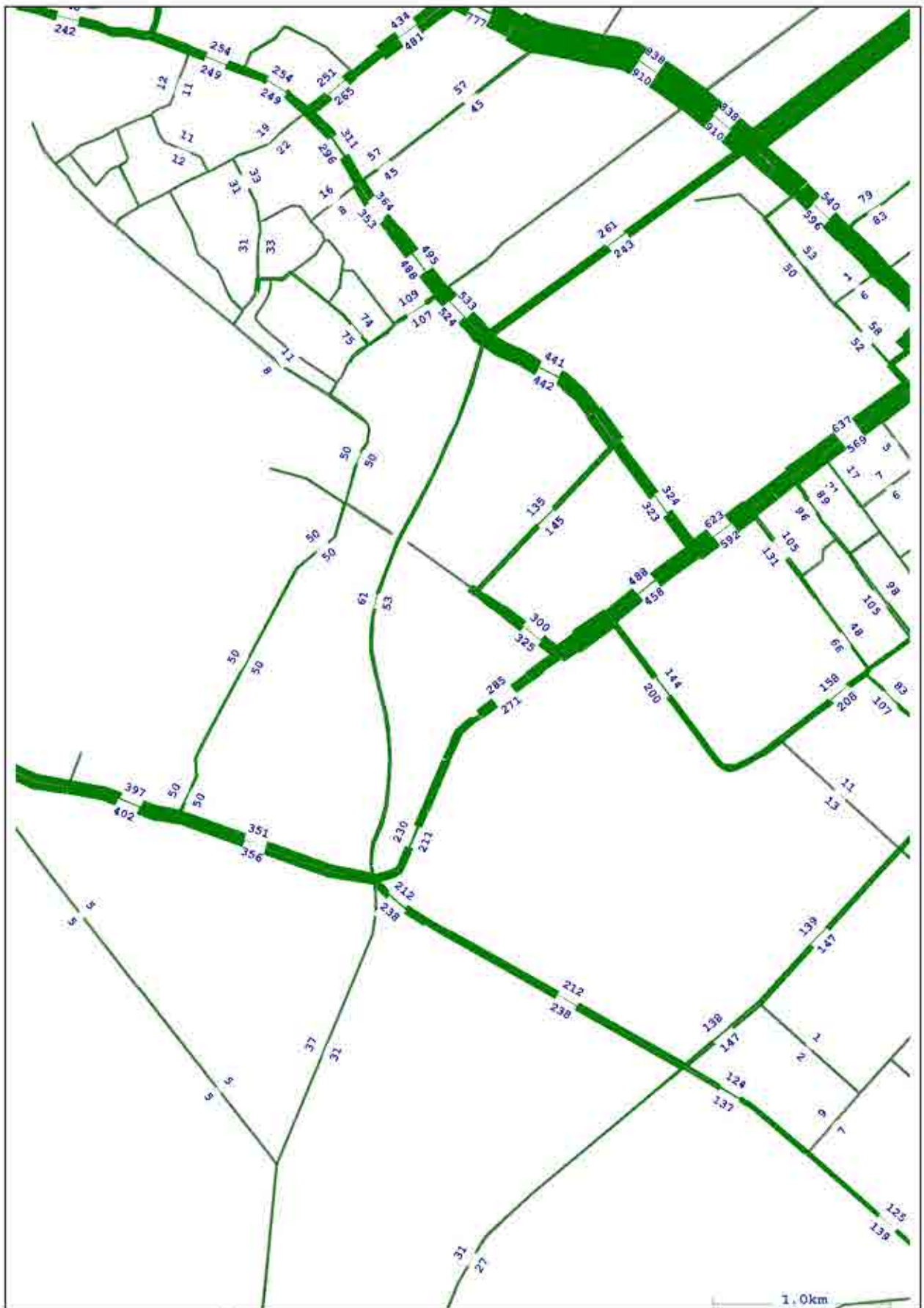

Hawke's Bay Irongate Modelling Gabites Porter Consultants	2026 SH Peak Irongate with Link Road Stage 2+ Development Traffic Volumes	Figure 11
--	--	------------------

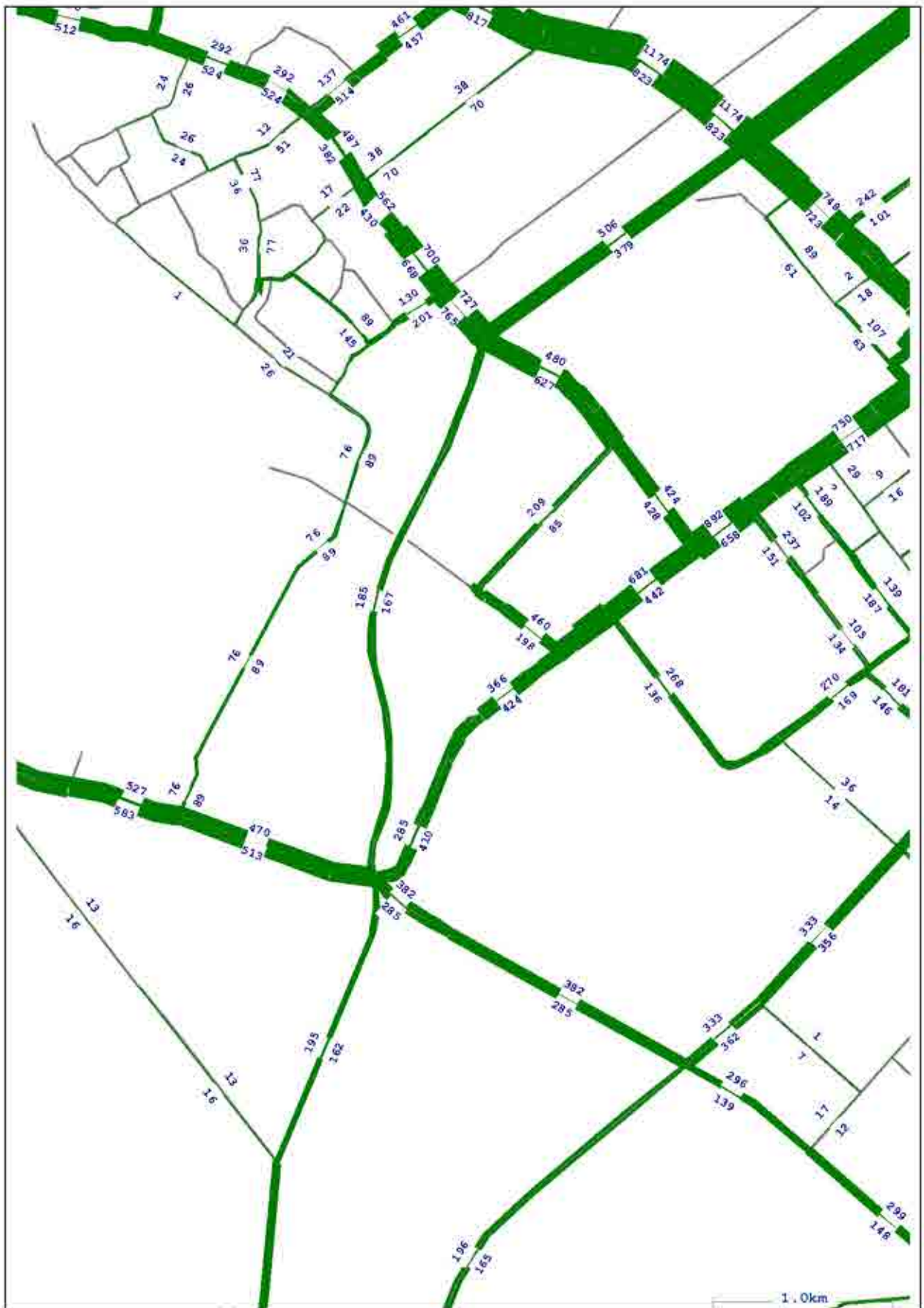

Hawke's Bay Irongate Modelling	2026 PM Peak Irongate with Link Road Stage 2+ Development Traffic Volumes	Figure 12
Gabites Porter Consultants		

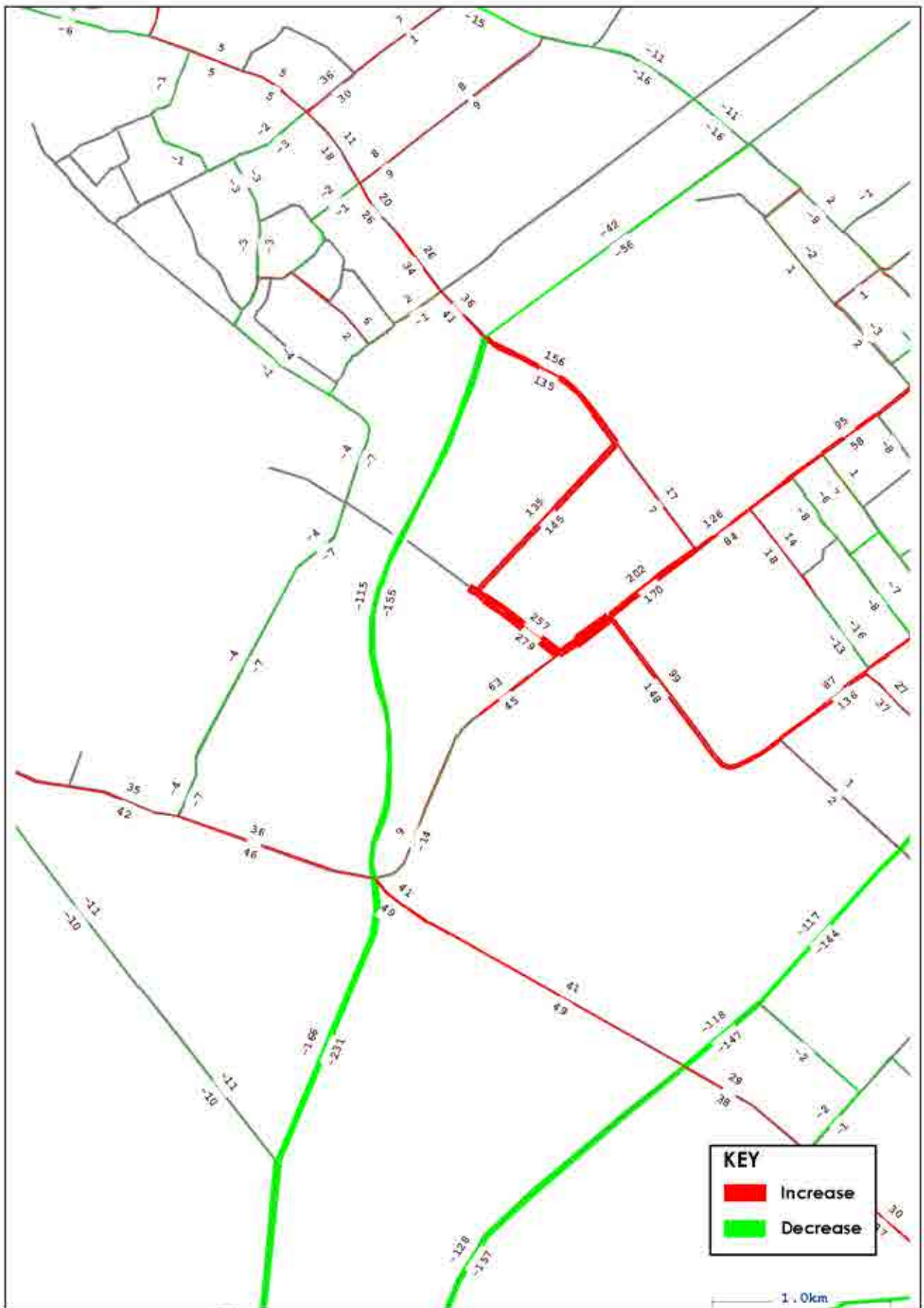

Hawke's Bay Irongate Modelling Gabites Porter Consultants	2026 SH Peak Irongate with Link Road Stage 2+ Development Change in Traffic Volumes to 2026 Base	Figure 14
--	---	------------------

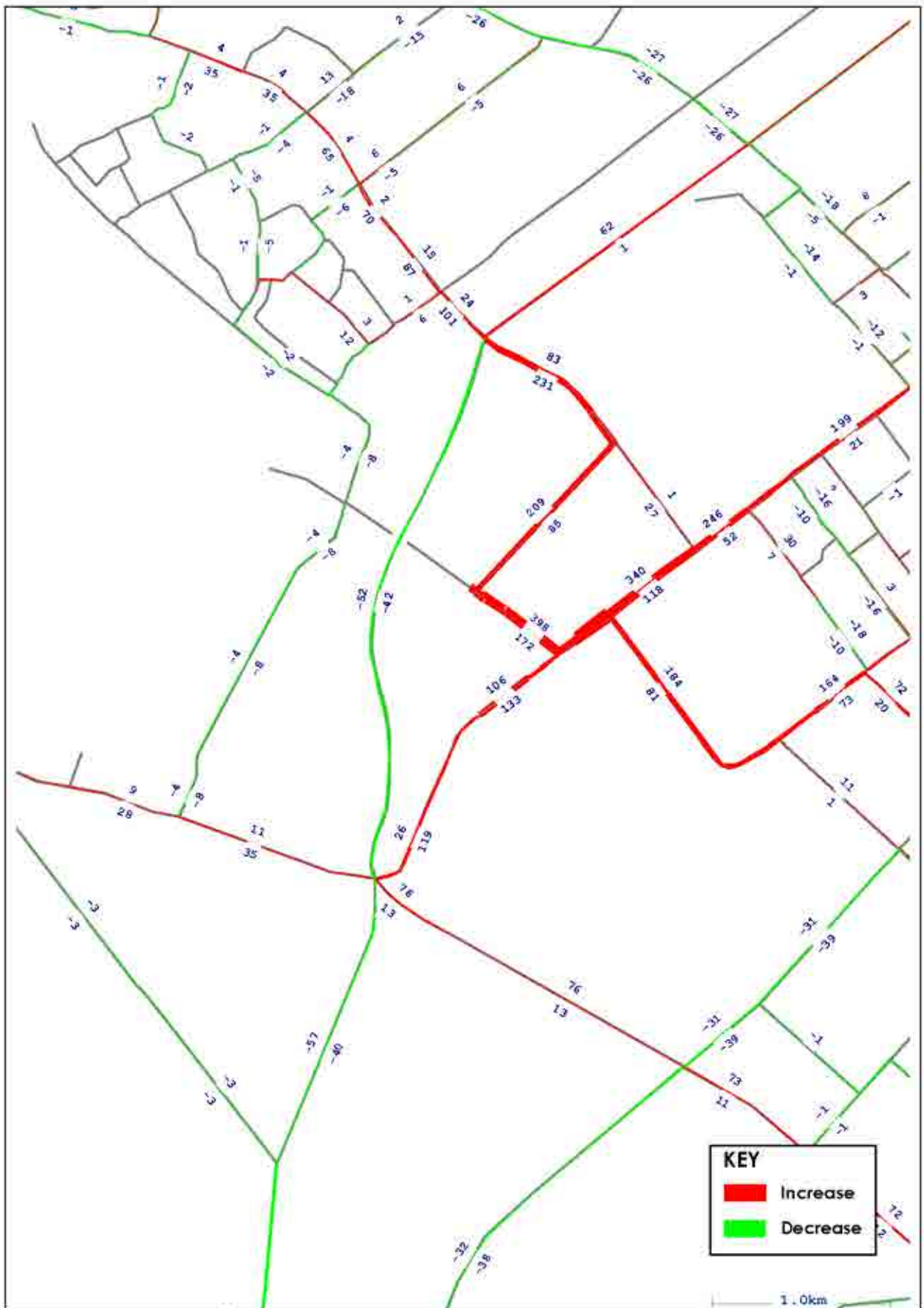

Hawke's Bay Irongate Modelling Gabites Porter Consultants	2026 PM Peak Irongate with Link Road Stage 2+ Development Change in Traffic Volumes to 2026 Base	Figure 15
--	---	------------------

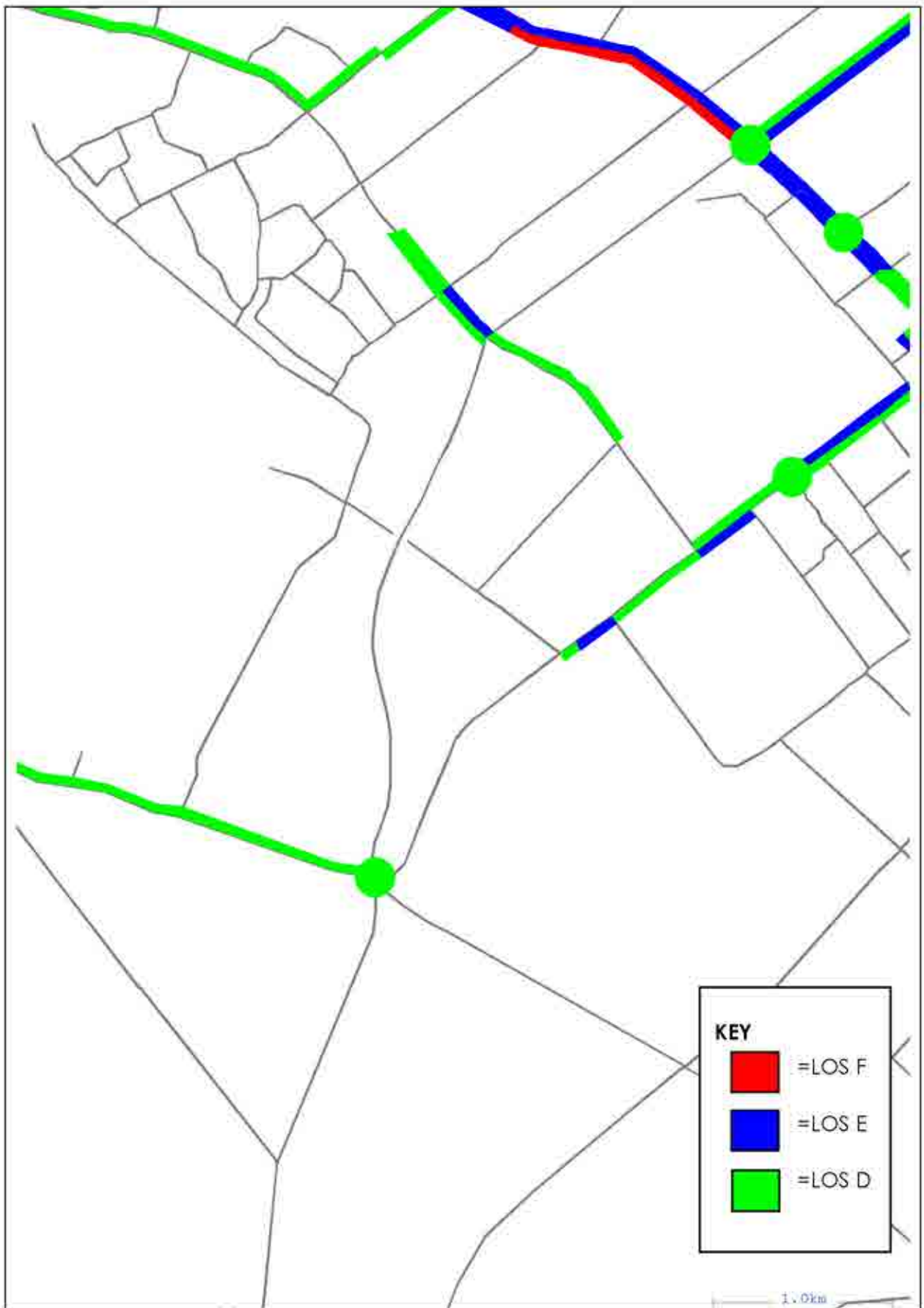

Hawke's Bay Irongate Modelling Gabites Porter Consultants	2026 AM Peak Irongate with Link Road Stage 2+ Development Level of Service	Figure 16
--	---	------------------

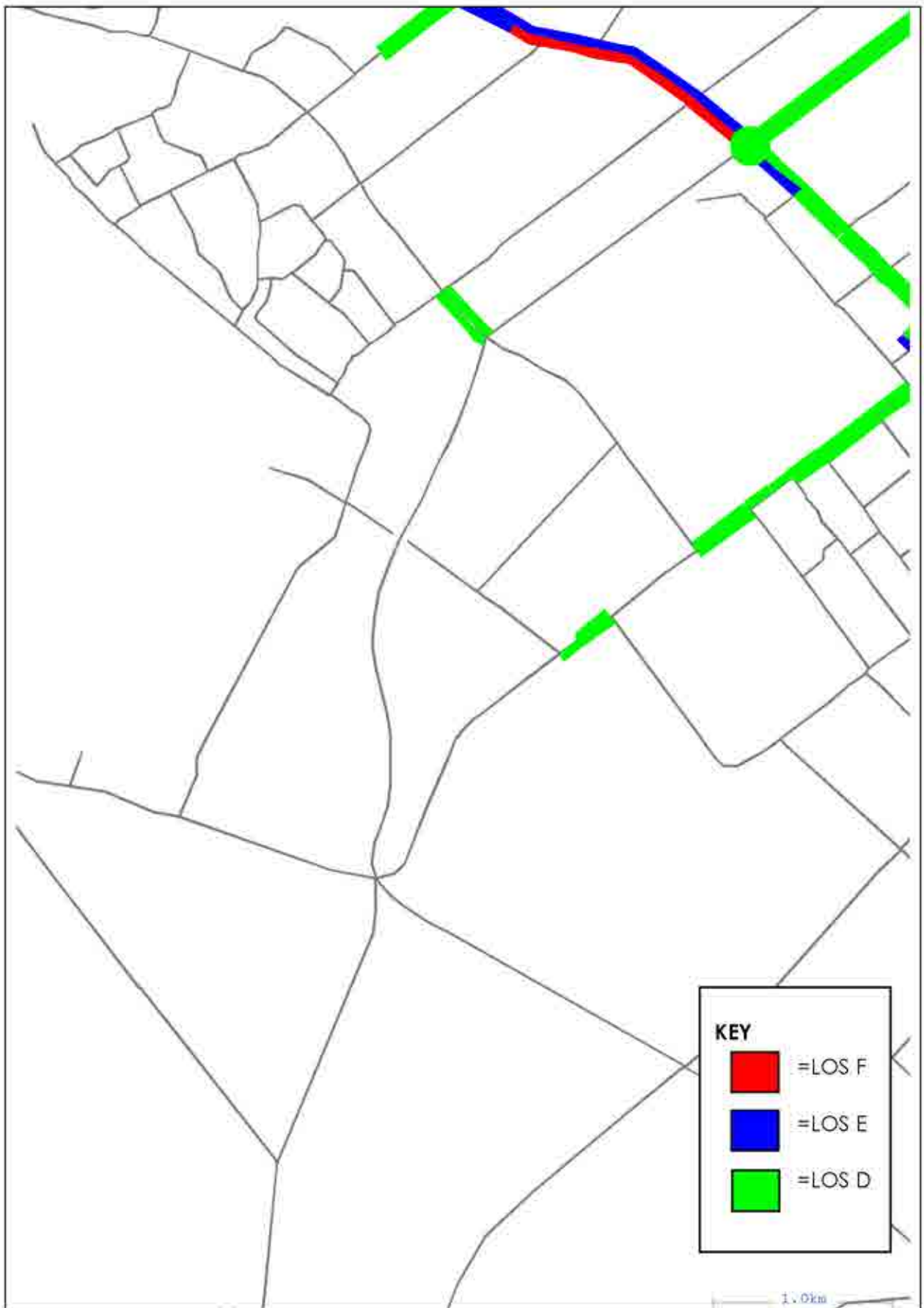

Hawke's Bay Irongate Modelling Gabites Porter Consultants	2026 SH Peak Irongate with Link Road Stage 2+ Development Level of Service	Figure 17
--	---	------------------

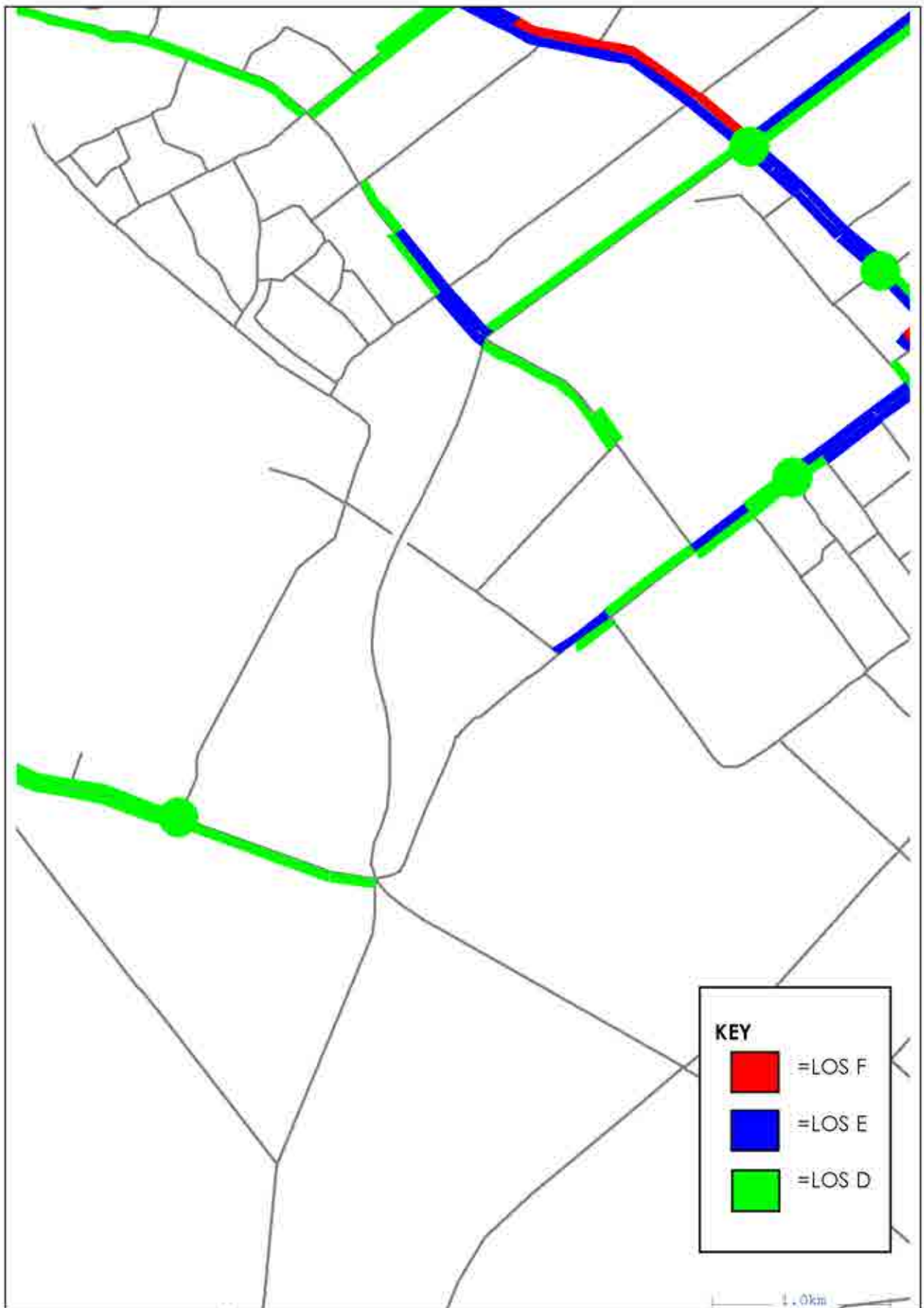

Hawke's Bay Irongate Modelling Gabites Porter Consultants	2026 PM Peak Irongate with Link Road Stage 2+ Development Level of Service	Figure 18
--	---	------------------

Irongate [2004-2008]

	Road	Distance	Direction	Intersection	Location	Reference	Date	Day	Time	Movement	Veh & Dir	Causes	Queue	Curve	Wind	Light	Weather	Junction	Control	Manings	Speed Limit	Fatal	Injured	Minor	Problems	Cyclist	Brexit	Noting
1	IRONGATE ROAD	150	N		MARAEKAKAHO ROAD	2456364	12/08/2004	Wed	1930	DA	CE1	103A 111A	F M D TN F					N N	N C	100	0	0	0			2836359	6166265	
2	IRONGATE ROAD	110	W		MARAEKAKAHO ROAD	2556313	20/12/2005	Tue	1657	DA	CE1	111A 402A	S M D O F					N C	N C	100	0	0	0			2836366	6166228	
3	IRONGATE ROAD	200	W		MARAEKAKAHO ROAD	2851007	3/01/2008	Sat	1338	LB	CN1T	303B 375B 831 929	M D O L D					N C	N C	100	0	0	0			2836347	6166314	
4	IRONGATE ROAD	220	N		SH 50A	2411745	4/10/2004	Sat	1745	DA	CE1	134A	F M D TN F					N C	N C	100	0	0	1			2836340	6166331	
5	IRONGATE ROAD	230	N		SH 50A	2413520	26/12/2004	Sun	2124	DC	CW1V	111A 121A 402A	M D DN F					N C	N C	100	0	1	3			2836332	6166337	
6	IRONGATE ROAD			I	STOCK ROAD	2656649	21/12/2008	Thu	2300	DB	CS2	101A 131A	R D DN F	X				N N	N C	100	0	0	0			2835292	6167031	
7	MARAEKAKAHO R	80	N		SH 50A	2813333	28/10/2008	Tue	1700	MC	CS1C	372B 921	F R D B F D					N L	N C	70	0	0	1			2837325	6166619	
8	STOCK ROAD	150	N		IRONGATE ROAD	2712311	26/05/2007	Sat	448	CB	CS1	104A 351A	R D DN F					N C	N C	100	0	2	0			2835342	6167172	
9	STOCK ROAD	25	S		IRONGATE ROAD	2555875	29/10/2005	Sat	2111	DB	CN1	131A 631A	V E D DN F					N C	N C	100	0	0	0			2835283	6167008	
10	STOCK ROAD	250	S		IRONGATE ROAD	2456525	20/12/2004	Mon	1130	DA	TS1	682A	M D O F					N C	N C	100	0	0	0			2835193	6166895	
11	STOCK ROAD	260	S		IRONGATE ROAD	2412392	10/08/2004	Fri	515	DA	CS1	111A 135A 617 844	V E W O L					N C	N C	100	0	0	1			2835185	6166798	
12	STOCK ROAD	300	S		IRONGATE ROAD	2751981	14/04/2007	Sat	2240	DA	CS1C	111A 514A	MT M D DN F					N C	N C	100	0	0	0			2835156	6166771	
13	STOCK ROAD	300	S		IRONGATE ROAD	2850119	1/12/2008	Sat	1216	DA	CN1	111A 134A	M D B F					N C	N C	100	0	0	0			2835156	6166771	
14	STOCK ROAD	310	S		IRONGATE ROAD	2552906	21/05/2005	Sat	2150	DA	CS1	131A 355A	SV M D DN F					N C	N C	100	0	0	0			2835149	6166784	
15	STOCK ROAD			I	IRONGATE ROAD	2452230	5/12/2004	Wed	1750	CA	CS1	112A 135A 612	V R D DN H	X				N C	N C	100	0	0	0			2835292	6167031	
16	STOCK ROAD			I	IRONGATE ROAD	2411824	18/04/2004	Sun	1000	HA	VN1C	321B 843	R D B F X	S				C	N C	100	0	0	2			2835292	6167031	
17	STOCK ROAD			I	IRONGATE ROAD	2711482	23/02/2007	Fri	745	LB	CN1C	144B 303B	R D B F X					N C	N C	100	0	0	1			2835292	6167031	
18	STOCK ROAD			I	IRONGATE ROAD	2651685	26/04/2006	Wed	1907	CB	CS14	129A 352A 662	R D DN F	X				G	N C	100	0	0	0			2835292	6167031	
19	STOCK ROAD			I	IRONGATE ROAD	2850101	18/01/2008	Fri	1645	JA	CS1C	321B	R D O F X	S				C	N C	100	0	0	0			2835292	6167031	
20	Z DWAY 47 YORK	450	N		SH 50A/MARAEKAKAH	2655040	18/10/2008	Wed	1338	CA	CN1	110A 138A	T R D B F					N N	N C	100	0	0	0			2836975	6167157	
21	HEATHCOTE ROAD			I	50A/0	2550111	14/01/2005	Fri	1428	DA	CN1	101A 111A	V R D B F	T				N C	N C	100	0	0	0			2836777	6166406	
22	FLAXMERE AVENUE			I	50A/0/9.257	2711701	25/03/2007	Sun	1555	DB	ME1	135A 330A 804	D E D B F	R				G	N C	100	0	1	1			2836201	6167965	
23	50A/0/9.257			I	FLAXMERE AVENUE	2759947	13/07/2007	Fri	200	DB	CE2	111A	FK M W DO	L				R	N C	100	0	0	0			2836201	6167965	
24	50A/0/9.3			I	FLAXMERE AVENUE	2855633	25/08/2008	Mon	710	DC	CS1V	110A 135A 301	I M W O H	R				G	N C	50	0	0	0			2836254	6167946	
25	50A/0/9.3			I	FLAXMERE AVENUE	2558119	14/12/2005	Wed	907	KA	VS1C	302A 614A	M W O L	R				G	N C	100	0	0	0			2836244	6167919	
26	50A/0/9.392			I	FLAXMERE AVENUE	2850784	2/03/2006	Fri	1734	FB	VN1C	353A 423A	R O B F	R				G	N C	100	0	0	0			2836247	6167916	
27	50A/0/9.392			I	FLAXMERE AVENUE	2856345	12/03/2008	Wed	750	FB	CN1C	331A	E D B F	R				G	N C	100	0	0	0			2836247	6167916	
28	50A/0/9.442	50	E		FLAXMERE AVENUE	2552896	19/06/2005	Sun	300	AF	CW1	132A	F R W DO	L				N C	N C	100	0	0	0			2836276	6167883	
29	50A/0/9.482	70	S		FLAXMERE AVENUE	2612060	23/05/2006	Tue	1820	BF	CN1C	123A 359A 167B	E W DO	L				N L	N C	100	0	1	3			2836291	6167866	
30	50A/0/9.482	100	E		FLAXMERE AVENUE	2552697	13/05/2005	Fri	310	CC	VS1	137A	R D DO	F				N C	N C	100	0	0	0			2836312	6167846	

	Road	Distance	Direction	Intersection	Location	Reference	Date	Day	Time	Measure	Verb & Dir.	Control	Object	Color	Wht	Light	Weather	Junction	Control	Markings	Speed Limit	Fall	Surface	Sign	Reference	Cycle	Existing	Noting	
31	50A/0/9.959	110	E		YORK ROAD N	2412622	29/08/2004	Sun	1522	AD		CNT		R	W	O	L		N	C	100	0	0	2		2836674	6167565		
32	50A/0/10.057	890	N		MARAEKAKAHO ROAD	2811454	3/11/2006	Sat	36	CC		CS1		V	R	D	DN	F		N	C	100	0	0	1		2836732	6167487	
33	50A/0/10.087	880	N		MARAEKAKAHO ROAD	2650245	29/01/2006	Sun	420	CC		CNT		P	R	W	DO	L		N	C	100	0	0	0		2836750	6167463	
34	50A/0/10.147	800	N		MARAEKAKAHO ROAD	2455899	30/09/2004	Thu	1608	AD		CE1C		FT	R	D	B	F		N	C	100	0	0	0		2836788	6167415	
35	50A/0/10.347	600	N		MARAEKAKAHO ROAD	2454290	24/08/2004	Tue	1130	GA		VNIV			R	D	B	F	D	N	C	100	0	0	0		2836905	6167254	
36	50A/0/10.477	470	N		MARAEKAKAHO ROAD	2553352	7/06/2005	Wed	1215	GA		CS1C		T	R	D	B	F	D	N	C	100	0	0	0		2836932	6167149	
37	50A/0/10.567	380	S		MARAEKAKAHO ROAD	2611270	2/03/2006	Fri	1820	CC		CNT		FV	R	D	O	F		N	C	100	0	0	1		2837035	6167077	
38	50A/0/10.647	300	W		MARAEKAKAHO	2654737	29/09/2006	Fri	1641	FA		CW1C			R	D	B	F		N	C	100	0	0	0		2837083	6167012	
39	50A/0/10.647	300	W		MARAEKAKAHO ROAD	2556804	15/12/2006	Fri	1725	FD		CE1CCC			R	D	B	F		N	C	100	0	0	0		2837083	6167012	
40	50A/0/10.654	200	N		MARAEKAKAHO ROAD	2451183	3/12/2004	Fri	1010	DB		CS1		E	D	B	F		N	C	100	0	0	0		2837142	6166932		
41	50A/0/10.887	260	S		MARAEKAKAHO ROAD	2513426	22/12/2005	Thu	1110	GD		CS1C			R	D	B	F	D	N	C	100	0	0	1		2837107	6166980	
42	50A/0/10.797	150	N		MARAEKAKAHO ROAD	2451287	4/01/2004	Thu	1020	EA		TS1C		M	R	D	B	F		N	C	100	0	0	0		2837172	6166892	
43	YORK ROAD	150	W		50A/0/10.797	2511161	15/01/2005	Sat	2220	OC		CE1		V	R	D	DO	F		N	C	100	0	0	1		2837172	6166892	
44	YORK ROAD	100	N		50A/0/10.847	2651925	5/04/2006	Thu	2120	EC		CS1		W	R	W	DN	M		N	C	100	0	0	0		2837202	6166851	
45	50A/0/10.854		I		MARAEKAKAHO ROAD	2450214	2/01/2004	Sun	2130	JA		CS1C			R	W	DO	L	T	G	C	70	0	0	0		2837261	6166771	
46	50A/0/10.887	60	N		MARAEKAKAHO ROAD	2756459	11/07/2007	Wed	800	FD		CS14			R	D	O	F		N	C	100	0	0	0		2837225	6166819	
47	50A/0/10.897	50	W		MARAEKAKAHO ROAD	2555047	22/09/2006	Thu	757	AD		CW1CO				R	D	B	F		N	C	70	0	0	0		2837231	6166811
48	MARAEKAKAHO ROAD		I		YORK ROAD	2650527	21/02/2006	Tue	1317	KB		CS1T			R	D	B	F	T	G	C	70	0	0	0		2837261	6166771	
49	50A/0/10.947		I		MARAEKAKAHO ROAD	2753527	14/06/2007	Thu	1520	JA		CN2D			R	W	O	L	T	G	C	70	0	0	0		2837261	6166771	
50	50A/0/10.947		I		MARAEKAKAHO ROAD	2751866	13/04/2007	Fri	1850	FB		XE1C			R	D	DO	F	T	G	R	70	0	0	0		2837261	6166771	
51	50A/0/10.947		I		MARAEKAKAHO ROAD	2533028	24/09/2005	Fri	827	FB		CS2V			R	W	OF	F	T	G	C	70	0	0	0		2837261	6166771	
52	50A/0/10.947		I		MARAEKAKAHO ROAD	2711280	15/01/2007	Mon	918	GA		CS1C			R	D	B	F	T	G	R	70	0	0	1		2837261	6166771	
53	50A/0/10.947		I		MARAEKAKAHO ROAD	2711224	2/03/2007	Sat	2310	FB		CE1C			R	W	DO	L	T	G	R	100	0	0	1		2837261	6166771	
54	50A/0/10.947		I		MARAEKAKAHO ROAD	2612055	6/09/2006	Fri	755	LB		CN1C			R	D	B	F	T	G	R	70	0	0	3		2837261	6166771	
55	50A/0/10.947		I		MARAEKAKAHO ROAD	2651535	4/09/2006	Sun	1206	LB		CN1C			R	D	B	F	T	G	R	70	0	0	0		2837261	6166771	
56	50A/0/10.947		I		YORK ROAD	2811193	2/05/2008	Tue	1705	JA		CN1C			R	D	O	F	T	G	C	70	0	0	1		2837261	6166771	
57	50A/0/10.947		I		YORK ROAD S	2652767	4/12/2006	Wed	400	DC		TE1		F	R	W	DO	L	T	G	C	100	0	0	0		2837261	6166771	
58	50A/0/10.947		I		YORK ROAD S	2553122	30/06/2005	Thu	1720	LB		4N1C			R	D	TO	F	T	G	P	50	0	0	0		2837261	6166771	
59	50A/0/10.947		I		YORK ROAD	2511742	22/04/2006	Fri	1715	LB		CN1V			R	D	TF	F	T	G	C	100	0	0	1		2837261	6166771	
60	50A/0/10.947		I		YORK ROAD	2851409	14/04/2008	Mon	1833	LB		CN1C			R	W	DO	L	T	G	C	70	0	0	0		2837261	6166771	
61	50A/0/10.947		I		MARAEKAKAHO ROAD	2412202	20/06/2004	Sun	2100	DC		CE1		G	R	W	DO	L	T	G	C	50	0	0	1		2837261	6166771	
62	50A/0/10.947		I		MARAEKAKAHO ROAD	2751853	23/04/2007	Mon	1445	FB		CE1C			R	D	B	F	T	G	C	70	0	0	0		2837261	6166771	
63	50A/0/10.947		I		MARAEKAKAHO ROAD	2613599	27/12/2006	Wed	932	LB		CN1C			R	D	O	F	T	G	L	100	0	1	2		2837261	6166771	
64	50A/0/10.947		I		MARAEKAKAHO ROAD	2411563	4/01/2004	Thu	1820	LB		CN1C			R	D	TO	F	T	G	C	70	0	0	2		2837261	6166771	
65	50A/0/10.947		I		MARAEKAKAHO ROAD	2512269	7/07/2005	Thu	1020	LB		CN1C			R	D	O	F	T	G	C	70	0	0	1		2837261	6166771	
66	50A/0/10.947		I		MARAEKAKAHO ROAD	2452184	22/05/2004	Sat	920	GA		CE1C			R	D	O	F	T	G	N	50	0	0	0		2837261	6166771	

	Road	Distance	Direction	Intersection	Location	Reference	Date	Day	Time	Movement	Veh. & Dir.	Count	Chart	Code	Wrt	Light	Weather	Junction	Control	Marking	Speed Limit	Fault	Surface	Misc.	Freeman	Cyclist	Entry	Flowing
67	50A/0/11.017	70	S		YORK ROAD S	2754477	8/10/2007	Fr	855	FD	→	331A 300A		R	D	B	F	N	C	70	0	0	0			2837205	6168729	
68	50A/0/11.047	100	S		YORK ROAD	2453508	8/01/2004	Sun	1654	CB	↘	137A		R	D	O	F	N	C	70	0	0	0			2837181	6168711	
69	50A/0/11.097	150	S		YORK ROAD S	2754977	30/08/2007	Thu	1327	CB	↘	615A 682A		R	D	B	F	N	C	100	0	0	0			2837141	6168681	
70	50A/0/11.097	150	S		YORK ROAD	2453092	22/09/2004	Tue	1715	FD	→	181A		R	D	DN	F	N	C	70	0	0	0			2837141	6168681	
71	50A/0/11.227	280	S		YORK ROAD	2450256	13/01/2004	Tue	2145	CC	↘	410A	FT	R	D	DN	F	N	C	100	0	0	0			2837037	6168602	
72	50A/0/11.347	400	S		YORK ROAD S	2613600	12/03/2006	Sun	1939	MG	→	372B		R	D	TN	F	N	C	100	0	2	0			2836942	6168530	
73	50A/0/11.461			I	HEATHCOTE ROAD	2611863	4/01/2008	Tue	2209	LB	↘	144B 303B 359B		R	D	DO	F	T	N	C	100	0	1	0			2836777	6168406
74	50A/0/11.461			I	HEATHCOTE ROAD	2612273	7/06/2006	Thu	1715	LB	↘	303B 362B		R	D	DO	F	T	S	C	100	0	0	2			2836777	6168406
75	HEATHCOTE ROAD			I	50A/0/11.553	2752447	4/11/2007	Wed	1852	DA	↘	131A 407A	V	R	D	DO	F	T	G	C	100	0	0	0			2836777	6168406
76	50A/W/11.553			I	HEATHCOTE ROAD	2656097	11/12/2006	Sun	1335	DA	↘	111A 400A	PV	R	D	O	F	T	G	C	100	0	0	0			2836777	6168406
77	50A/0/11.653	100	S		HEATHCOTE ROAD	2755582	10/01/2007	Mon	1410	CC	↘	137A 130B	C	R	D	B	F	N	C	100	0	0	0			2836697	6168346	
78	50A/W/11.921	110	N		IRONGATE ROAD	2756971	15/11/2007	Thu	1015	CC	↘	500A	CF	R	D	B	F	N	C	100	0	0	0			2836462	6168185	
79	50A/0/12.018	80	S		IRONGATE ROAD	2412085	16/06/2004	Wed	1731	GA	↘	331A 927		R	D	TD	F	D	N	C	100	0	0	1			2836331	6168070
80	50A/0/12.031			I	IRONGATE ROAD	2451768	22/04/2004	Thu	1515	JA	↘	302B		R	D	O	F	T	G	L	100	0	0	0			2836304	6168119
81	50A/0/12.031			I	IRONGATE ROAD	2453328	19/07/2004	Mon	826	JA	↘	302B 375B		R	D	O	F	T	G	L	100	0	0	0			2836304	6168119
82	50A/0/12.031			I	IRONGATE ROAD	2612250	31/05/2008	Sat	1505	LB	↘	124A 377A 402A		R	D	B	F	T	G	R	100	0	0	2			2836394	6168119
83	50A/0/12.031			I	IRONGATE ROAD	2755376	6/07/2007	Fri	804	JA	↘	302B 375B		R	D	B	F	T	G	R	100	0	0	0			2836394	6168119
84	50A/0/12.089	150	S		IRONGATE ROAD	2510034	23/04/2003	Sat	516	PA	↘	359A		R	D	DN	F	N	L	100	1	0	0	20		2836275	6168027	
85	50A/0/12.489	550	W		IRONGATE ROAD	2554091	8/04/2005	Thu	1249	DB	↘	501A	F	E	D	B	F	N	C	100	0	0	0			2835965	6163776	
86	50A/0/13.099	500	N		LONGLANDS ROAD W	2712148	23/04/2007	Mon	938	FF	↘	181A 191B		R	D	B	F	N	C	100	0	0	1			2835750	6165907	
87	50A/0/13.267	240	N		LONGLANDS ROAD W	2411144	13/01/2004	Tue	1530	FD	→	181A 353A		R	D	O	L	N	C	100	0	0	1			2835647	6165068	
88	50A/0/13.307	200	N		LONGLANDS ROAD W	2511515	4/01/2005	Fr	600	CC	↘	134A 410A		R	D	B	F	N	C	100	0	0	1			2835631	6165031	
89	50A/0/13.428	170	N		LONGLANDS ROAD W	2652542	27/05/2006	Sat	2322	DB	↘	388A	V	E	W	DN	M	N	C	100	0	0	0			2835619	6165004	
90	50A/0/13.542			I	LONGLANDS ROAD W	2611537	28/03/2006	Tue	2138	DA	↘	136A 402A 562A	V	E	D	DO	F	R	G	R	50	0	0	1			2835546	6164807
91	50A/0/13.542			I	LONGLANDS ROAD W	2412923	10/10/2004	Sun	1740	CA	↘	110A 132A 801	F	R	W	O	L	R	G	R	50	0	0	1			2835546	6164807
92	50A/0/13.608	60	W		LONGLANDS ROAD EA	2755835	25/09/2007	Tue	1807	DA	↘	111A 133A	V	R	W	DN	L	N	R	100	0	0	0			2835542	6164850	
93	MARAEKAKAHO ROAD			I	50A/0/13.634	2851399	15/04/2006	Tue	1109	LB	↘	132A 404A	IS	R	W	O	L	X	G	R	100	0	0	0			2835521	6164839
94	50A/0/13.634			I	LONGLANDS ROAD W	2655610	24/10/2006	Tue	1710	CB	↘	400A 420A	V	R	W	B	L	X	G	R	100	0	0	0			2835520	6164822
95	50A/0/13.634			I	MARAEKAKAHO ROAD	2856290	23/01/2008	Wed	1350	CA	↘	110A 687A		R	D	B	F	R	G	R	50	0	0	0			2835520	6164822
96	50A/0/13.669			I	LONGLANDS ROAD W	2656059	12/10/2006	Sun	1430	FB	→	331A		E	D	B	F	R	G	C	100	0	0	0			2835527	6164904

Irongate [2004-2008]

	Roadname	Distance	Direction	Intersection	Location	Reference	Date	Weekday	Time	Movement	Causes	Witness	Light	Weather	Junction	Control	Fatal	Serious	Minor	Escalting	Non-Inj
1	IRONGATE ROAD	150	N	MARA EKAKAHO ROAD		2456364	12/06/2004	Wed	1830	DA	CAR1 alcohol test above limit or test refused, too fast entering corner	Dry	Twilight	Fine	Unknown	Ni	0	0	0	2836358	6168285
2	IRONGATE ROAD	110	W	MARA EKAKAHO ROAD		2556313	20/12/2005	Tue	1857	DA	CAR1 too fast entering corner, new driver showed inexperience	Dry	Overcast	Fine	Unknown	Ni	0	0	0	2836368	6168226
3	IRONGATE ROAD	200	W	MARA EKAKAHO ROAD		2651007	3/01/2008	Sat	1338	LB	TRUCK2 failed to give way when turning to non-turning traffic, didn't see/look when required to give way to traffic from another direction ENV/visibility limited by curve, entering or leaving private house / farm	Dry	Overcast	Light Rain	Driveway	Ni	0	0	0	2836347	6168314
4	IRONGATE ROAD	220	N	SH 50A		2411745	4/10/2004	Sat	1745	DA	CAR1 lost control while returning to seal from unsealed shoulder	Dry	Twilight	Fine	Unknown	Ni	0	0	1	2836340	6168331
5	IRONGATE ROAD	230	N	SH 50A		2413528	26/12/2004	Sun	2124	BC	CAR1 too fast entering corner, swung wide on bend, new driver showed inexperience	Dry	Dark	Fine	Unknown	Ni	0	1	3	2836332	6168337
6	IRONGATE ROAD		I	STOCK ROAD		2656649	21/12/2006	Thu	2300	DB	CAR1 alcohol suspected, lost control when turning	Dry	Dark	Fine	X Type Junction	Ni	0	0	0	2835292	6167031
7	MARA EKAKAHO ROAD	80	N	SH 50A		2813333	28/10/2006	Tue	1700	MC	CAR2 didn't see/look behind when changing lanes, position or direction ENV: writing or leaving roadside stall	Dry	Bright Sun	Fine	Driveway	Ni	0	0	1	2837328	6168619
8	STOCK ROAD	150	N	IRONGATE ROAD		2712311	26/05/2007	Sat	446	CB	CAR1 alcohol test result unknown, attention diverted by passengers	Dry	Dark	Fine	Unknown	Ni	0	2	0	2835342	6167172
9	STOCK ROAD	25	S	IRONGATE ROAD		2655875	29/10/2005	Sat	2111	DB	CAR1 lost control when turning, puncture or blowout	Dry	Dark	Fine	Unknown	Ni	0	0	0	2835283	6167008
10	STOCK ROAD	250	S	IRONGATE ROAD		2456525	20/12/2004	Mon	1130	DA	TRUCK1 load not well secured or moved	Dry	Overcast	Fine	Unknown	Ni	0	0	0	2835193	6168805
11	STOCK ROAD	260	S	IRONGATE ROAD		2412992	10/08/2004	Fri	518	DA	CAR1 too fast entering corner, lost control due to road conditions ENV: road surface under construction or maintenance, signs / signals necessary	Wet	Overcast	Light Rain	Unknown	Ni	0	0	1	2835188	6168796
12	STOCK ROAD	300	S	IRONGATE ROAD		2751961	14/04/2007	Sat	2240	DA	CAR1 too fast entering corner, evading enforcement	Dry	Dark	Fine	Unknown	Ni	0	0	0	2835156	6168771
13	STOCK ROAD	300	S	IRONGATE ROAD		2850119	1/12/2008	Sat	1216	DA	CAR1 too fast entering corner, lost control while returning to seal from unsealed shoulder	Dry	Bright Sun	Fine	Unknown	Ni	0	0	0	2835156	6168771
14	STOCK ROAD	310	S	IRONGATE ROAD		2552906	21/05/2005	Sat	2150	DA	CAR1 lost control when turning, attention diverted while trying to find intersection	Dry	Dark	Fine	Unknown	Ni	0	0	0	2835149	6168764
15	STOCK ROAD		I	IRONGATE ROAD		2452230	5/12/2004	Wed	1750	CA	CAR1 too fast on straight, lost control due to road conditions ENV: road surface (uneven)	Dry	Dark	Heavy Rain	X Type Junction	Ni	0	0	0	2835292	6167031
16	STOCK ROAD		I	IRONGATE ROAD		2411824	16/04/2004	Sun	1000	HA	CAR2 did not stop at stop sign ENV: signs / signals ineffective or inadequate	Dry	Bright Sun	Fine	X Type Junction	Stop Sign	0	0	2	2835292	6167031
17	STOCK ROAD		I	IRONGATE ROAD		2711482	23/02/2007	Fri	745	LB	CAR2 didn't signal in time when turning right, failed to give way when turning to non-turning traffic	Dry	Bright Sun	Fine	X Type Junction	Ni	0	0	1	2835292	6167031
18	STOCK ROAD		I	IRONGATE ROAD		2651688	26/04/2006	Wed	1907	CB	CAR1 too far left/right, attention diverted by other traffic ENV: street lighting inadequate	Dry	Dark	Fine	X Type Junction	Give Way Sign	0	0	0	2835292	6167031
19	STOCK ROAD		I	IRONGATE ROAD		2850101	16/01/2008	Fri	1645	JA	CAR2 did not stop at stop sign	Dry	Overcast	Fine	X Type Junction	Stop Sign	0	0	0	2835292	6167031
20	Z DWAY 47 YORK	480	N	SH 50A/MARA EKAKAHO		2655040	16/10/2006	Wed	1338	CA	CAR1 too fast for conditions, lost control on unsealed road	Dry	Bright Sun	Fine	Unknown	Ni	0	0	0	2838976	6167157
21	HEATHCOTE ROAD		I	50A/R0		2650111	14/01/2005	Fri	1428	DA	CAR1 alcohol suspected, too fast entering corner	Dry	Bright Sun	Fine	T Type Junction	Ni	0	0	0	2836777	6168406

	Roadname	Distance	Direction	Intersection	Location	Reference	Date	Weekday	Time	Movement	Causes	Witness	Light	Weather	Junction	Control	Fatal	Serious	Minor	Escaping	Nothing
22	FLAXMERE AVENUE		I	50A/0/9.257		2711701	25/03/2007	Sun	1555	DB	MOTOR CYCLE1 lost control due to road conditions, inattentive. ENV: road slippery (loose material on seal)	Dry	Bright Sun	Fine	Roundabout	Give Way Sign	0	1	1	2835201	6167965
23	50A/0/9.257		I	FLAXMERE AVENUE		2753947	13/07/2007	Fri	260	DB	CAR1 too fast entering corner	Wet	Dark	Light Rain	Roundabout	Give Way Sign	0	0	0	2835201	6167965
24	50A/0/9.3		I	FLAXMERE AVENUE		2855633	25/09/2008	Mon	710	DC	CAR1 too fast for conditions, lost control due to road conditions. ENV: road slippery (rain)	Wet	Overcast	Heavy Rain	Roundabout	Give Way Sign	0	0	0	2836254	6167946
25	50A/0/9.3		I	FLAXMERE AVENUE		2556119	14/12/2005	Wed	907	KA	VAN1 failed to give way at give way sign, service brake defective.	Wet	Overcast	Light Rain	Roundabout	Give Way Sign	0	0	0	2835244	6167919
26	50A/0/9.392		I	FLAXMERE AVENUE		2650764	2/03/2006	Fri	1734	FB	VAN1 attention diverted by other traffic, wrong pedal	Dry	Bright Sun	Fine	Roundabout	Give Way Sign	0	0	0	2835247	6167916
27	50A/0/9.392		I	FLAXMERE AVENUE		2856345	12/03/2008	Wed	750	FB	CAR1 failed to notice car slowing.	Dry	Bright Sun	Fine	Roundabout	Give Way Sign	0	0	0	2835247	6167916
28	50A/0/9.442	50	E	FLAXMERE AVENUE		2552868	19/06/2005	Sun	200	AF BF	CAR1 lost control under heavy braking CAR1 cutting corner on bend, cell phone, communication or navigation device. CAR2 suddenly swerved to avoid vehicle	Wet	Dark	Light Rain	Unknown	Nil	0	0	0	2836278	6167893
29	50A/0/9.462	70	S	FLAXMERE AVENUE		2612060	23/05/2006	Tue	1620	AF BF	CAR1 lost control under heavy braking CAR1 cutting corner on bend, cell phone, communication or navigation device. CAR2 suddenly swerved to avoid vehicle	Wet	Dark	Light Rain	Unknown	Nil	0	1	3	2835291	6167658
30	50A/0/9.492	100	E	FLAXMERE AVENUE		2552697	13/05/2005	Fri	310	CC	VAN1 lost control avoiding another vehicle	Dry	Dark	Fine	Unknown	Nil	0	0	0	2836312	6167846
31	50A/0/9.959	110	E	YORK ROAD N		2412622	29/08/2004	Sat	1522	AD	CAR1 lost control under heavy braking	Wet	Overcast	Light Rain	Unknown	Nil	0	0	2	2836674	6167585
32	50A/0/10.057	690	N	MARA EKAKAHO ROAD		2611454	3/11/2006	Sat	36	CC	CAR1 alcohol or drugs, alcohol suspected, lost control	Dry	Dark	Fine	Unknown	Nil	0	0	1	2836732	6167487
33	50A/0/10.087	660	N	MARA EKAKAHO ROAD		2650245	29/01/2006	Sun	420	CC	CAR1 alcohol test above limit or test refused, lost control, fatigue (drowsy, tired, fell asleep)	Wet	Dark	Light Rain	Unknown	Nil	0	0	0	2836750	6167423
34	50A/0/10.147	600	N	MARA EKAKAHO ROAD N		2455899	30/09/2004	Thu	1608	AD	CAR1 lost control under heavy braking, cut in after overtaking. CAR2 intimidating driving	Dry	Bright Sun	Fine	Unknown	Nil	0	0	0	2836786	6167415
35	50A/0/10.347	600	N	MARA EKAKAHO ROAD N		2454290	24/08/2004	Tue	1130	GA	VAN1 following too closely, failed to notice indication of vehicle in front. ENV: entering or leaving private house / farm	Dry	Bright Sun	Fine	Driveway	Nil	0	0	0	2836905	6167254
36	50A/0/10.477	470	N	MARA EKAKAHO ROAD		2553352	7/06/2005	Wed	1215	GA	CAR1 lost control under heavy braking, following too closely. ENV: entering or leaving private house / farm	Dry	Bright Sun	Fine	Driveway	Nil	0	0	0	2836982	6167149
37	50A/0/10.567	390	S	MARA EKAKAHO ROAD		2611270	2/03/2006	Fri	1820	CC	CAR1 lost control, fatigue (drowsy, tired, fell asleep)	Dry	Overcast	Fine	Unknown	Nil	0	0	1	2837035	6167077
38	50A/0/10.647	300	W	MARA EKAKAHO ROAD		2654737	22/09/2008	Fri	1641	FA	CAR1 alcohol test above limit or test refused, cut in after overtaking	Dry	Bright Sun	Fine	Unknown	Nil	0	0	0	2837083	6167012
39	50A/0/10.647	300	W	MARA EKAKAHO ROAD		2656804	15/12/2006	Fri	1723	FD	CAR1 failed to notice car slowing, fatigue (drowsy, tired, fell asleep)	Dry	Bright Sun	Fine	Unknown	Nil	0	0	0	2837083	6167012
40	50A/0/10.654	200	N	MARA EKAKAHO ROAD N		2451183	3/12/2004	Fri	1010	DB	CAR1 alcohol test below limit, lost control under heavy braking	Dry	Bright Sun	Fine	Unknown	Nil	0	0	0	2837142	6166932
41	50A/0/10.687	260	S	MARA EKAKAHO ROAD		2513426	22/12/2005	Thu	1110	GD	CAR1 failed to notice car slowing, attention diverted by advertising or signs. ENV: entering or leaving roadside stall	Dry	Bright Sun	Fine	Driveway	Nil	0	0	1	2837107	6166980
42	50A/0/10.797	180	N	MARA EKAKAHO ROAD		2451287	4/01/2004	Thu	1020	EA	TRUCK1 too far left/right, misjudged speed of own vehicle. ENV: visibility limited by parked vehicle	Dry	Bright Sun	Fine	Unknown	Nil	0	0	0	2837172	6166892
43	YORK ROAD	150	W	50A/0/10.797		2511161	15/01/2005	Sat	2220	CC	CAR1 fatigue (drowsy, tired, fell asleep)	Dry	Dark	Fine	Unknown	Nil	0	0	1	2837172	6166892
44	YORK ROAD	100	N	50A/0/10.847		2651925	5/04/2006	Thu	2120	EC	CAR1 did not see or look for other party until too late. ENV: farm animal straying	Wet	Dark	Mist	Unknown	Nil	0	0	0	2837202	6166851
45	50A/0/10.854		I	MARA EKAKAHO ROAD N		2450214	2/01/2004	Sun	2130	JA	CAR2 failed to give way at give way sign	Wet	Dark	Light Rain	T Type Junction	Give Way Sign	0	0	0	2837261	6166771
46	50A/0/10.887	60	N	MARA EKAKAHO ROAD		2756459	11/07/2007	Wed	800	FD	CAR1 following too closely, new driver showed inexperience	Dry	Overcast	Fine	Unknown	Nil	0	0	0	2837225	6166819
47	50A/0/10.897	50	W	MARA EKAKAHO ROAD		2555047	22/09/2005	Thu	752	AD	CAR1 lost control when turning, suddenly swerved to avoid vehicle. CAR2 didn't see/look behind when changing lanes, position or direction, blind spot	Dry	Bright Sun	Fine	Unknown	Nil	0	0	0	2837231	6166811

	Roadname	Distance	Direction	Intersection	Location	Reference	Date	Weekday	Time	Movement	Causes	Witness	Light	Weather	Junction	Control	Fatal	Serious	Minor	Easting	Northing
88	MARAEKAKAHO ROAD				YORK ROAD	2650527	21/02/2006	Tue	1317	YB	TRUCK2 failed to give way at give way sign, didnt see/look when required to give way to traffic from another direction	Dry	Bright Sun	Fine	T Type Junction	Give Way Sign	0	0	0	2837261	6166771
89	50A/0/10.947				MARAEKAKAHO ROAD	2753527	14/08/2007	Thu	1520	JA	OTHER2 didnt see/look when visibility obstructed by other vehicles ENV failed to give way at give way sign	Wet	Overcast	Light Rain	T Type Junction	Give Way Sign	0	0	0	2837261	6166771
90	50A/0/10.947				MARAEKAKAHO ROAD	2751868	13/04/2007	Fri	1850	FB	TAXI1 following too closely	Dry	Dark	Fine	T Type Junction	Give Way Sign	0	0	0	2837261	6166771
91	50A/0/10.947				MARAEKAKAHO ROAD	2553028	24/06/2005	Fri	827	FB	CAR1 failed to notice car slowing ENV entering or leaving other commercial	Wet	Overcast	Fine	T Type Junction	Give Way Sign	0	0	0	2837261	6166771
92	50A/0/10.947				MARAEKAKAHO ROAD	2711260	15/01/2007	Mon	918	GA	CAR1 attention diverted by other traffic, misjudged intentions of another party	Dry	Bright Sun	Fine	T Type Junction	Give Way Sign	0	0	1	2837261	6166771
93	50A/0/10.947				MARAEKAKAHO ROAD	2711224	2/03/2007	Sat	2310	FB	CAR1 too fast on straight	Wet	Dark	Light Rain	T Type Junction	Give Way Sign	0	0	1	2837261	6166771
94	50A/0/10.947				MARAEKAKAHO ROAD	2612065	6/09/2006	Fri	755	LB	CAR2 failed to give way when turning to non-turning traffic, misjudged intentions of another party	Dry	Bright Sun	Fine	T Type Junction	Give Way Sign	0	0	3	2837261	6166771
95	50A/0/10.947				MARAEKAKAHO ROAD	2651535	4/09/2006	Sun	1206	LB	CAR1 didnt signal in time incorrect signal, travelled straight ahead from turning lane or flush median CAR2 failed to give way when turning to non-turning traffic	Dry	Bright Sun	Fine	T Type Junction	Give Way Sign	0	0	0	2837261	6166771
96	50A/0/10.947				YORK ROAD	2811193	2/05/2006	Tue	1705	JA	CAR2 failed to give way at give way sign, didnt see/look when required to give way to traffic from another direction	Dry	Overcast	Fine	T Type Junction	Give Way Sign	0	0	1	2837261	6166771
97	50A/0/10.947				YORK ROAD S	2652767	4/12/2006	Wed	400	DC		Wet	Dark	Light Rain	T Type Junction	Give Way Sign	0	0	0	2837261	6166771
98	50A/0/10.947				YORK ROAD S	2553122	30/06/2006	Thu	1720	LB	SUV1 alcohol test above limit or test refused CAR2 failed to give way when turning to non-turning traffic, attention diverted by other traffic, didnt see/look when visibility obstructed by other vehicles	Dry	Twilight	Fine	T Type Junction	Give Way Sign	0	0	0	2837261	6166771
99	50A/0/10.947				YORK ROAD	2511742	22/04/2005	Fri	1715	LB	CAR1 didnt signal in time incorrect signal VAN2 failed to give way when turning to non-turning traffic	Dry	Twilight	Fine	T Type Junction	Give Way Sign	0	0	1	2837261	6166771
100	50A/0/10.947				YORK ROAD	2851409	14/04/2008	Mon	1833	LB	CAR2 failed to give way when turning to non-turning traffic, didnt see/look when required to give way to traffic from another direction	Wet	Dark	Light Rain	T Type Junction	Give Way Sign	0	0	0	2837261	6166771
101	50A/0/10.947				MARAEKAKAHO ROAD	2412202	20/09/2004	Sun	2100	DC	CAR1 alcohol test above limit or test refused, too fast on straight, lost control under heavy braking	Wet	Dark	Light Rain	T Type Junction	Give Way Sign	0	0	1	2837261	6166771
102	50A/0/10.947				MARAEKAKAHO ROAD	2751853	23/01/2007	Mon	1415	FB	CAR1 too fast to give way at intersection, failed to notice car slowing	Dry	Bright Sun	Fine	T Type Junction	Give Way Sign	0	0	0	2837261	6166771
103	50A/0/10.947				MARAEKAKAHO ROAD	2610599	27/12/2006	Wed	932	LB	CAR2 failed to give way when turning to non-turning traffic, misjudged intentions of another party	Dry	Overcast	Fine	T Type Junction	Give Way Sign	0	1	2	2837261	6166771
104	50A/0/10.947				MARAEKAKAHO ROAD N	2411563	4/01/2004	Thu	1820	LB	CAR2 failed to give way when turning to non-turning traffic, did not see or look for other party until too late	Dry	Twilight	Fine	T Type Junction	Give Way Sign	0	0	2	2837261	6166771
105	50A/0/10.947				MARAEKAKAHO ROAD N	2512268	7/07/2005	Thu	1020	LB	CAR2 failed to give way at give way sign, attention diverted by other traffic, didnt see/look when visibility obstructed by other vehicles	Dry	Overcast	Fine	T Type Junction	Give Way Sign	0	0	1	2837261	6166771
106	50A/0/10.947				MARAEKAKAHO ROAD N	2452184	29/05/2004	Sat	920	GA	CAR1 failed to notice car slowing	Dry	Overcast	Fine	T Type Junction	Give Way Sign	0	0	0	2837261	6166771
107	50A/0/11.017	70	S		YORK ROAD S	2754477	8/10/2007	Fri	855	FD	CAR1 failed to notice car slowing, attention diverted by driver dazzled by sunlights	Dry	Bright Sun	Fine	Unknown	Nil	0	0	0	2837205	6166729
108	50A/0/11.047	100	S		YORK ROAD	2453509	8/01/2004	Sun	1654	CB	CAR1 lost control avoiding another vehicle	Dry	Overcast	Fine	Unknown	Nil	0	0	0	2837181	6166711

	Roadname	Distance	Direction	Intersection	Location	Reference	Date	Weekday	Time	Assessment	Causes	Moistness	Light	Weather	Junction	Control	Fatal	Serious	Minor	Escalting	Nothing
69	50A/0/1.097	150	S		YORK ROAD S	2754977	30/08/2007	Thu	1327	CA	VAN1 jack-knifed, load not well secured or moved	Dry	Bright Sun	Fine	Unknown	Nil	0	0	0	2837141	6166681
70	50A/0/1.097	150	S		YORK ROAD	2453092	22/09/2004	Tue	1715	FD	CAR1 following too closely	Dry	Dark	Fine	Unknown	Nil	0	0	0	2837141	6166681
71	50A/0/1.122/	280	S		YORK ROAD	2450256	13/01/2004	Tue	2145	CC	CAR1 fatigue (drowsy, tired, fell asleep)	Dry	Dark	Fine	Unknown	Nil	0	0	0	2837037	6166602
72	50A/0/1.1347	400	S		YORK ROAD S	2613600	12/03/2006	Sun	1930	MG	CAR2 didnt see/look behind when changing lanes, position or direction	Dry	Twilight	Fine	Unknown	Nil	0	2	0	2836942	6166530
73	50A/0/11.461				HEATHCOTE ROAD	2811803	4/01/2008	Tue	2209	LB	CAR2 didnt signal in-time when turning right, failed to give way when turning to non-turning traffic, cell phone, communication or navigation device	Dry	Dark	Fine	T Type Junction	Nil	0	1	0	2836777	6166406
74	50A/0/11.461				HEATHCOTE ROAD	2612273	7/06/2006	Thu	1715	LB	CAR2 failed to give way when turning to non-turning traffic, misjudged speed etc of vehicle coming from another dirn with right of way	Dry	Dark	Fine	T Type Junction	Stop Sign	0	0	2	2836777	6166406
75	HEATHCOTE ROAD				50A/0/11.553	2752447	4/11/2007	Wed	1852	DA	VAN1 lost control when turning, driver over-reacted	Dry	Dark	Fine	T Type Junction	Give Way Sign	0	0	0	2836777	6166406
76	50A/0/11.553				HEATHCOTE ROAD	2856097	11/12/2006	Sun	1935	DA	CAR1 too fast entering corner, inexperience	Dry	Overcast	Fine	T Type Junction	Give Way Sign	0	0	0	2836777	6166406
77	50A/0/11.883	100	S		HEATHCOTE ROAD	2755802	10/01/2007	Mon	1410	CC	CAR1 lost control avoiding another vehicle. CAR2 lost control	Dry	Bright Sun	Fine	Unknown	Nil	0	0	0	2835697	6166346
78	50A/0/11.921	110	N		IRONGATE ROAD	2756971	15/11/2007	Thu	1015	CC	CAR1 illness and disability	Dry	Bright Sun	Fine	Unknown	Nil	0	0	0	2836482	6166185
79	50A/0/12.019	90	S		IRONGATE ROAD	2412085	16/06/2004	Wed	1731	GA	CAR1 failed to notice car slowing. ENV: entering or leaving other commercial	Dry	Twilight	Fine	Driveway	Nil	0	0	1	2836331	6166070
80	50A/0/12.031				IRONGATE ROAD	2451768	22/04/2004	Thu	1515	JA	CAR2 failed to give way at give way sign	Dry	Overcast	Fine	T Type Junction	Give Way Sign	0	0	0	2836394	6166119
81	50A/0/12.031				IRONGATE ROAD	2453328	19/07/2004	Mon	829	JA	CAR2 failed to give way at give way sign, didnt see/look when required to give way to traffic from another direction	Dry	Overcast	Fine	T Type Junction	Give Way Sign	0	0	0	2836394	6166119
82	50A/0/12.031				IRONGATE ROAD	2812290	31/05/2008	Sat	1505	LB	CAR1 cutting corner at intersection, didnt see/look when visibility obstructed by other vehicles, new driver showed inexperience	Dry	Bright Sun	Fine	T Type Junction	Give Way Sign	0	0	2	2836394	6166119
83	50A/0/12.031				IRONGATE ROAD	2755376	9/07/2007	Fri	804	JA	CAR2 failed to give way at give way sign, didnt see/look when required to give way to traffic from another direction	Dry	Bright Sun	Fine	T Type Junction	Give Way Sign	0	0	0	2836394	6166119
84	50A/0/12.089	150	S		IRONGATE ROAD	2510034	23/04/2005	Sat	510	PA	TRUCK1 cell phone, communication or navigation device	Dry	Dark	Fine	Unknown	Nil	1	0	0	2836275	6166027
85	50A/0/12.489	550	W		IRONGATE ROAD	2554091	9/04/2005	Thu	1249	DB	CAR1 illness with no warning (eg heart attack)	Dry	Bright Sun	Fine	Unknown	Nil	0	0	0	2835965	6165776
86	50A/0/13.099	500	N		LONGLANDS ROAD WEST	2712148	23/04/2007	Mon	939	FF	TRUCK1 following too closely. TRUCK2 suddenly braked	Dry	Bright Sun	Fine	Unknown	Nil	0	0	1	2835750	6165307
87	50A/0/13.267	240	N		LONGLANDS ROAD WEST	2411144	13/01/2004	Tue	1530	FD	CAR1 following too closely, attention diverted by other traffic	Dry	Overcast	Light Rain	Unknown	Nil	0	0	1	2835647	6165068
88	50A/0/13.307	200	N		LONGLANDS ROAD WEST	2811515	4/01/2005	Fri	803	CC	VAN1 lost control while returning to seal from unsealed shoulder, fatigue (drowsy, tired, fell asleep)	Dry	Bright Sun	Fine	Unknown	Nil	0	0	1	2835631	6165031
89	50A/0/13.429	170	N		LONGLANDS ROAD WEST	2852542	27/05/2008	Sat	2322	DB	CAR1 misjudged speed of own vehicle	Wet	Dark	Mist	Unknown	Nil	0	0	0	2835619	6165004
90	50A/0/13.542				LONGLANDS ROAD WEST	2611537	29/03/2006	Tue	2138	DA	CAR1 lost control due to vehicle fault, new driver showed inexperience, suspension failure	Dry	Dark	Fine	Roundabout	Give Way Sign	0	0	1	2835548	6164807
91	50A/0/13.542				LONGLANDS ROAD WEST	2412923	10/10/2004	Sun	1740	CA	CAR1 too fast for conditions, lost control under heavy braking. ENV: road slippery (rain)	Wet	Overcast	Light Rain	Roundabout	Give Way Sign	0	0	1	2835548	6164807
92	50A/0/13.806	60	W		LONGLANDS ROAD EAST	2755836	25/09/2007	Tue	1807	DA	CAR1 too fast entering corner, lost control under heavy acceleration	Wet	Dark	Light Rain	Unknown	Nil	0	0	0	2835542	6164850
93	MARAEKAKAHO ROAD				50A/0/13.634	2851399	15/04/2008	Tue	1108	LB	CAR1 lost control under heavy braking, overseas driver failed to adjust to local conditions	Wet	Overcast	Light Rain	X Type Junction	Give Way Sign	0	0	0	2835521	6164839

irongate [2004-2008]

Number of records = 96

ANALYSIS OF FACTORS ASSOCIATED WITH CRASHES

Year			Month			Day			Time of Accident			Movement Type			Direction of Travel			Curve Type			Witness			Object(s) Struck (up to 3)							
Value	Freq	%	Value	Freq	%	Value	Freq	%	Value	Freq	%	Value	Freq	%	Value	Freq	%	Value	Freq	%	Value	Freq	%	Value	Freq	%	Value	Freq	%		
2004	24	25	1	16	17	MON	8	8	0	0	0	A	4	4																	
2005	18	19	2	2	2	TUE	14	15	100	1	1	B	2	2	North	41	43	R	74	77	D	75	78	A	0	0					
2006	23	24	3	7	7	WED	13	14	200	2	2	C	16	19	South	32	33	E	10	10	W	21	22	B	0	0					
2007	19	20	4	13	14	THU	15	16	300	0	0	D	23	24	East	15	16	M	12	13	I	0	0	C	2	4					
2008	12	13	5	8	8	FRI	18	19	400	2	2	E	2	2	West	8	8	S	0	0				D	1	2					
2009	0	0	6	9	9	SAT	14	15	500	2	2	F	14	15											E	0	0				
2010	0	0	7	5	5	SUN	14	15	600	2	2	G	6	6											F	13	28				
2011	0	0	8	6	6				700	0	0	H	1	1												G	1	2			
2012	0	0	9	6	6				800	7	7	J	7	7												H	0	0			
2013	0	0	10	8	8				900	4	4	K	2	2												I	2	4			
2014	0	0	11	3	3				1000	8	6	L	14	15													J	0	0		
2015	0	0	12	13	14				1100	4	4	M	2	2													K	1	2		
2026	0	0							1200	4	4	N	0	0														L	0	0	
2027	0	0							1300	4	4	O	0	0														M	2	4	
2028	0	0							1400	8	8	P	1	1														N	0	0	
2029	0	0							1500	4	4	Q	0	0														O	0	0	
2030	0	0							1600	5	6																	P	2	4	
2031	0	0							1700	6	8																	Q	0	0	
2032	0	0							1800	12	13																	R	0	0	
2033	0	0							1900	7	7																	S	3	6	
2034	0	0							2000	3	3																	T	5	11	
2035	0	0							2100	1	1																	U	0	0	
2036	0	0							2200	7	7																	V	14	30	
2037	0	0							2300	4	4																	W	1	2	
2038	0	0							2400	2	2																	X	0	0	
2039	0	0							U	0	0																	Y	0	0	
	96	100		96	100		96	100		96	100		96	100		96	100		96	100		96	100					Z	0	0	
																														47	100

 Grid Ref Box: Easting 0835149 to 0837303
 Northing 6164604 to 6167965

Light			Weather			Junction			Control			Markings			Speed Limit			Accident Types			Pedestrian Age			Cyclist Age					
Value	Freq	%	Value	Freq	%	Value	Freq	%	Value	Freq	%	Value	Freq	%	Value	Freq	%	Value	Freq	%	Value	Freq	%	Value	Freq	%	Value	Freq	%
B	35	36	F	73	76	D	8	6	0	0	X	0	0	30	0	0	F	1	1	0	0	0	0	0	0	0			
BO	0	0	FF	0	0				T	0	0	R	19	20	50	7	7	S	7	7	4	0	0	4	0	0			
BF	0	0	FS	0	0	M	0	0	S	3	3	P	1	1	60	0	0	M	26	27	8	0	0	8	0	0			
BN	0	0	M	2	2	R	10	10	G	39	41	L	6	6	70	18	19	N	62	65	12	0	0	12	0	0			
BU	0	0	MF	0	0	T	29	30	M	0	0	C	86	89	80	0	0		96	100	16	0	0	16	0	0			
O	22	23	MS	0	0	X	8	8	P	0	0	N	4	4	90	0	0				20	1	1	20	0	0			
OO	0	0	L	19	20	Y	0	0	N	54	56				100	71	74				24	0	0	24	0	0			
OF	1	1	LF	0	0																28	0	0	28	0	0			
ON	0	0	LS	0	0																32	0	0	32	0	0			
OU	0	0	H	2	2																36	0	0	36	0	0			
T	0	0	HF	0	0																40	0	0	40	0	0			
TO	3	3	HS	0	0																44	0	0	44	0	0			
TF	1	1	S	0	0																48	0	0	48	0	0			
TN	3	3	SP	0	0																52	0	0	52	0	0			
TU	0	0	SS	0	0																56	0	0	56	0	0			
D	0	0																			60	0	0	60	0	0			
DO	16	17																			64	0	0	64	0	0			
DF	0	0																			68	0	0	68	0	0			
DN	15	16																			0	0	0	0	0	0			
DU	0	0																										0	0
	96	100		96	100		96	100		96	100		96	100		96	100				1	1		0	0				

_irongate [2004-2008]

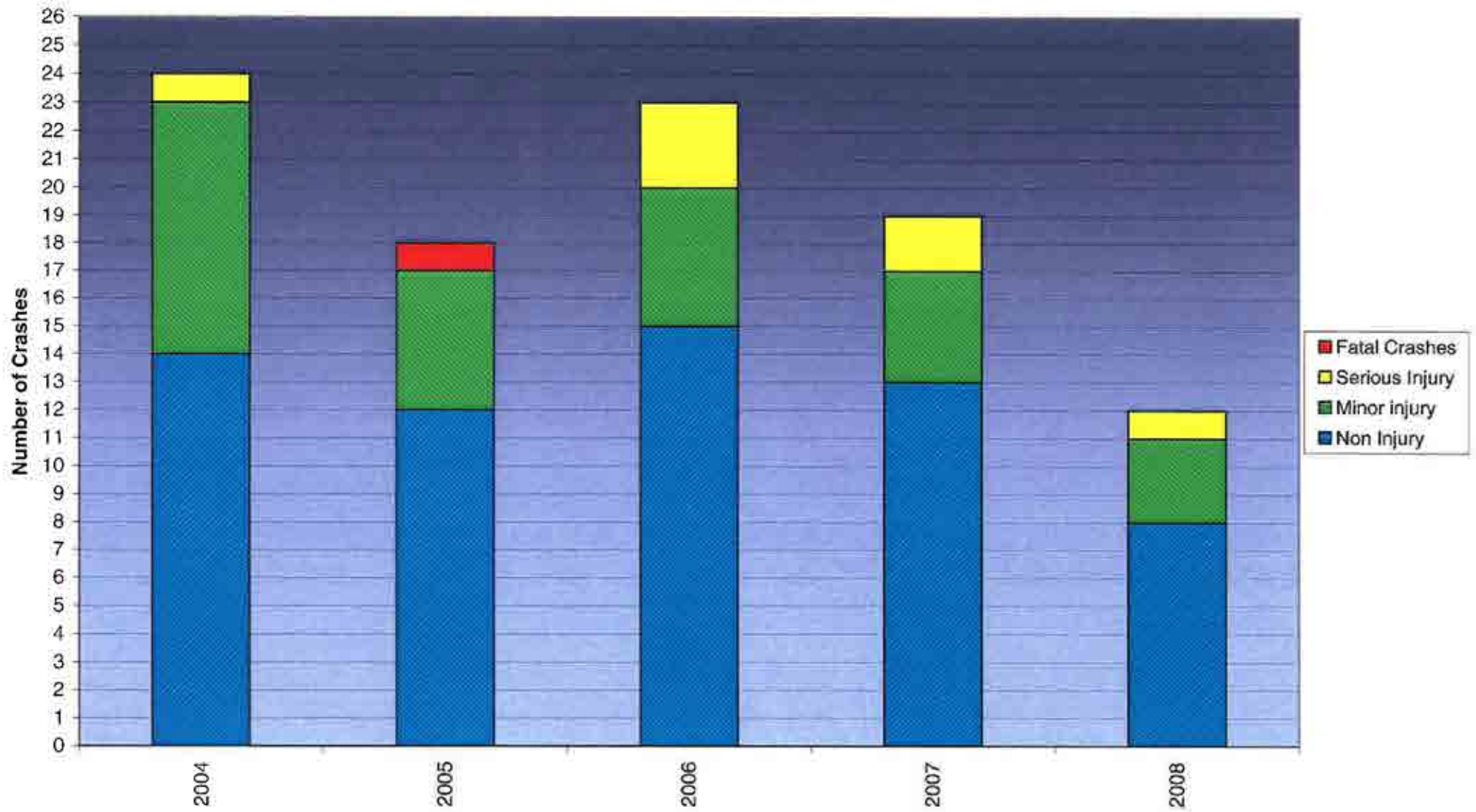

_irongate [2004-2008]

ACCIDENT TYPE (Similar Movements/Accident Costs) - sorted by "Vehicle 1"

(Note that the vehicle type having the highest crash cost varies depending on movement category and crash severity. The following chart does not identify the highest cost vehicle where more than one vehicle was involved.)

Movement	Codes	Bus (B,L)				Truck (T)				Car (C,V,X,Other)				Motorbike (M,P)				Push Cycle (S)				
		F	S	M	N	F	S	M	N	F	S	M	N	F	S	M	N	F	S	M	N	
Head On	AB,B										2											
Hit Object	E							1						1								
Lost Control Off Road	AD,CB,CC,CO,D							2		1	9	27		1								
Lost Control On Road	CA							1			1	2										
Miscellaneous	Q																					
Overtaking	AA,AC,AE-AO,GE											1										
Pedestrian	N,P					1																
Rear End, Crossing	FB,FC,GD										2	6										
Rear End, Queuing	FD,FE,FF,FO							1			1	4										
Rear End, Slow Vehicle	FA,GA-GC,GO										2	4										
Crossing, Direct	H										1											
Crossing, Turning	J,K,L,M							2		2	8	11		1	1							
All Movements	All																					
(Irregular Coding)	(None of above)																					
Total =						1		1	6		5	24	56		2	1						

Total Fatal = 1
 Total Serious = 7
 Total Minor = 26
 Total Non Injury = 62
 96

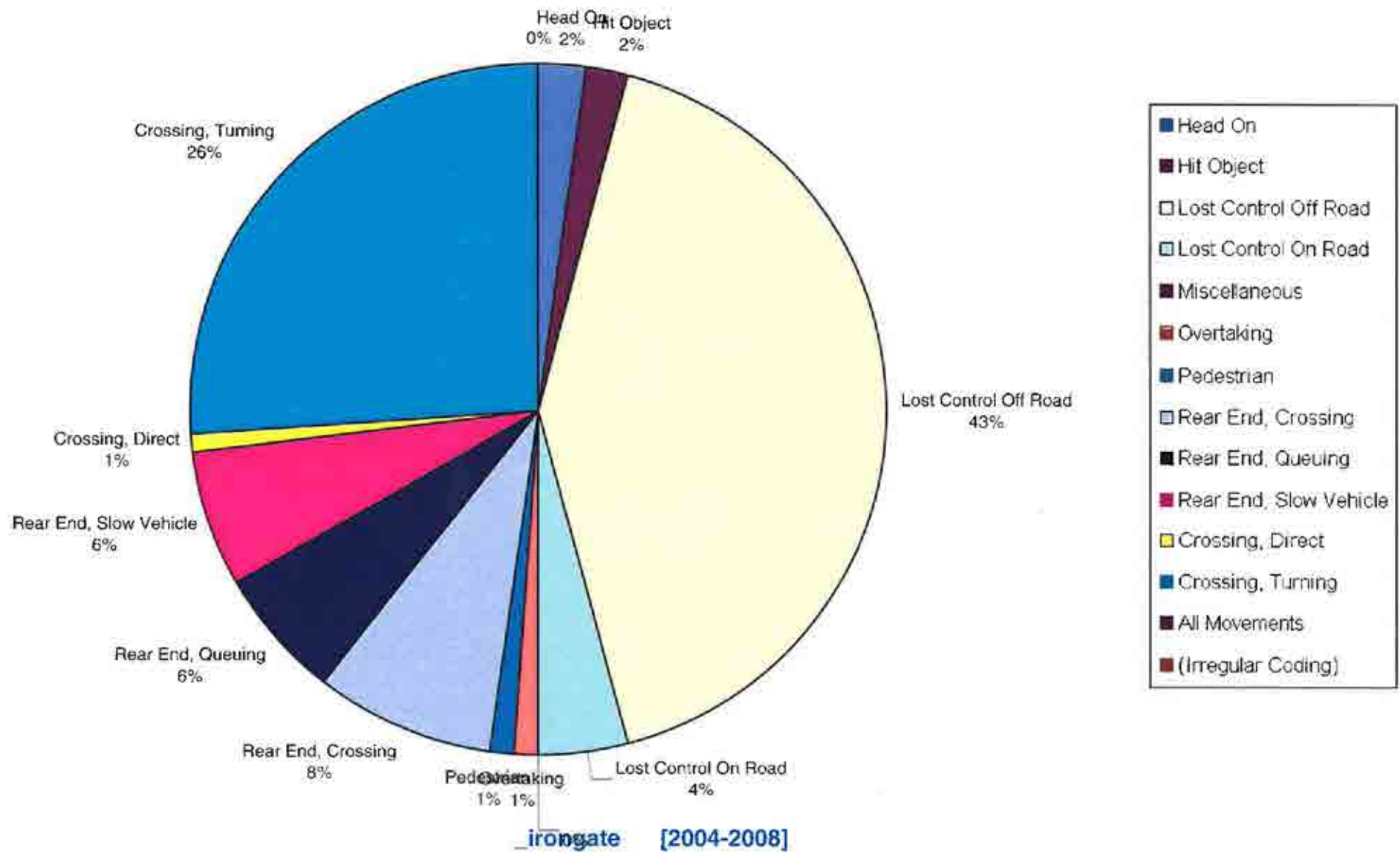

_irongate [2004-2008]

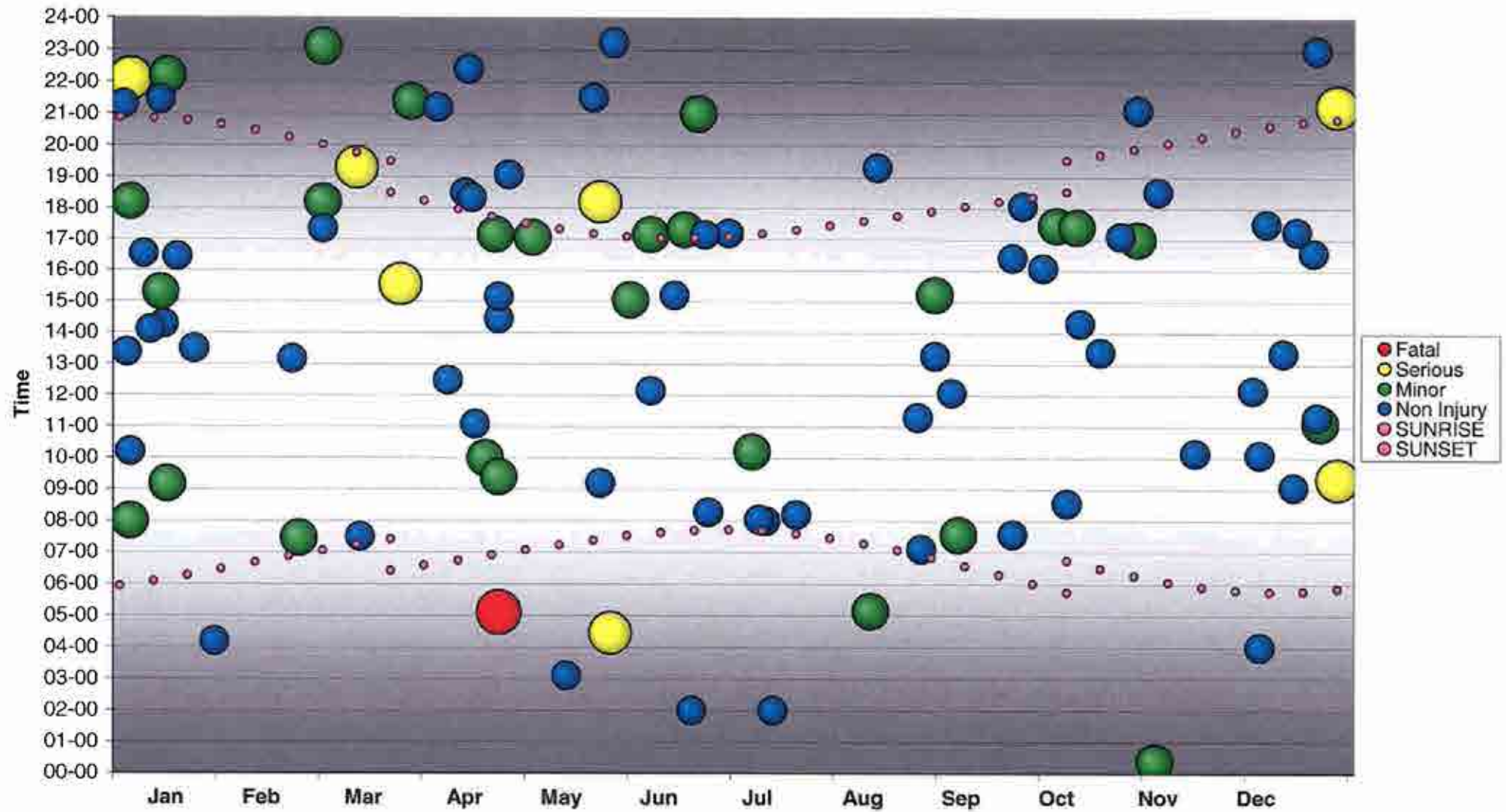

Hourly Crash Distribution

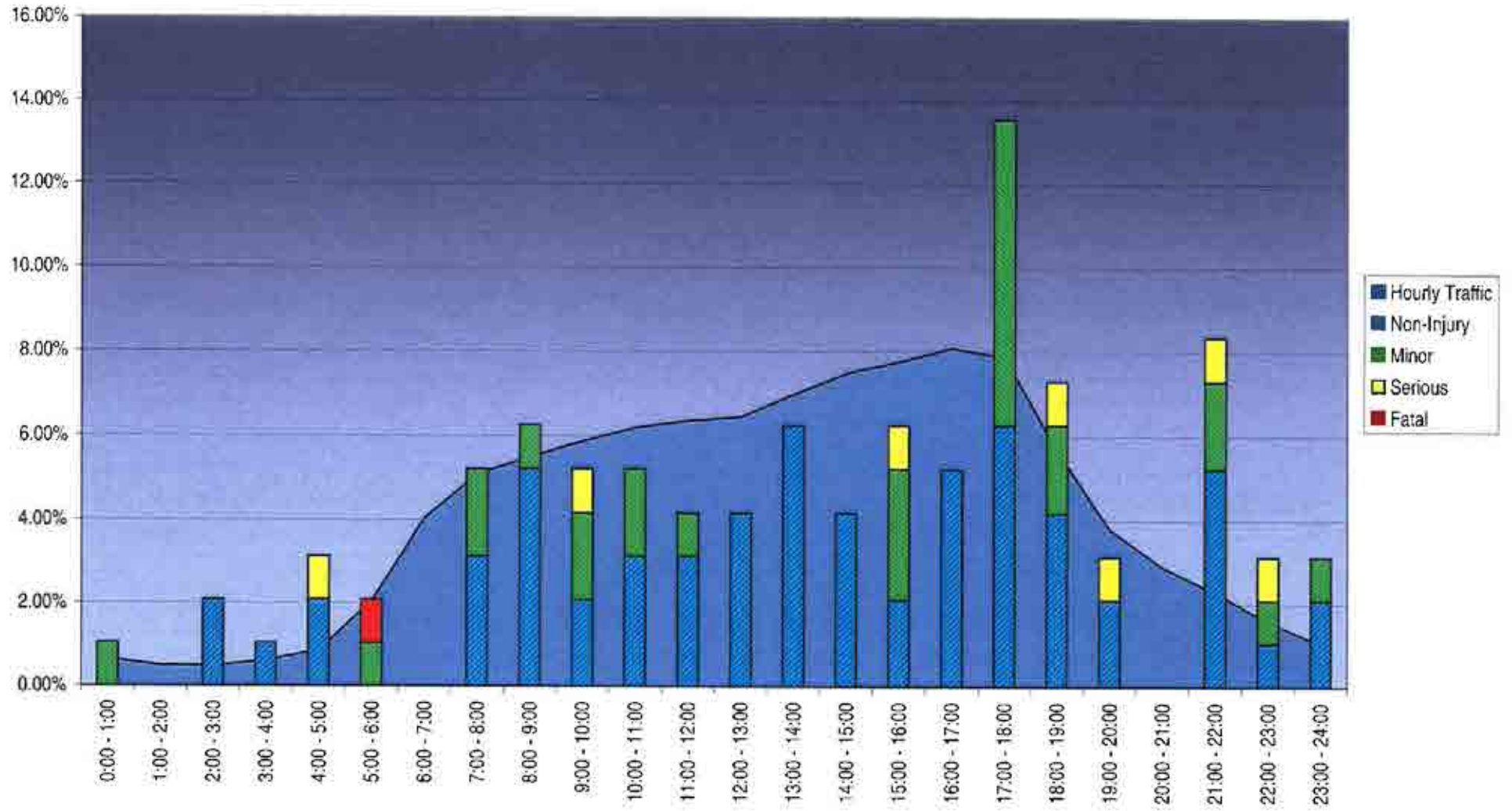

_irongate [2004-2008]

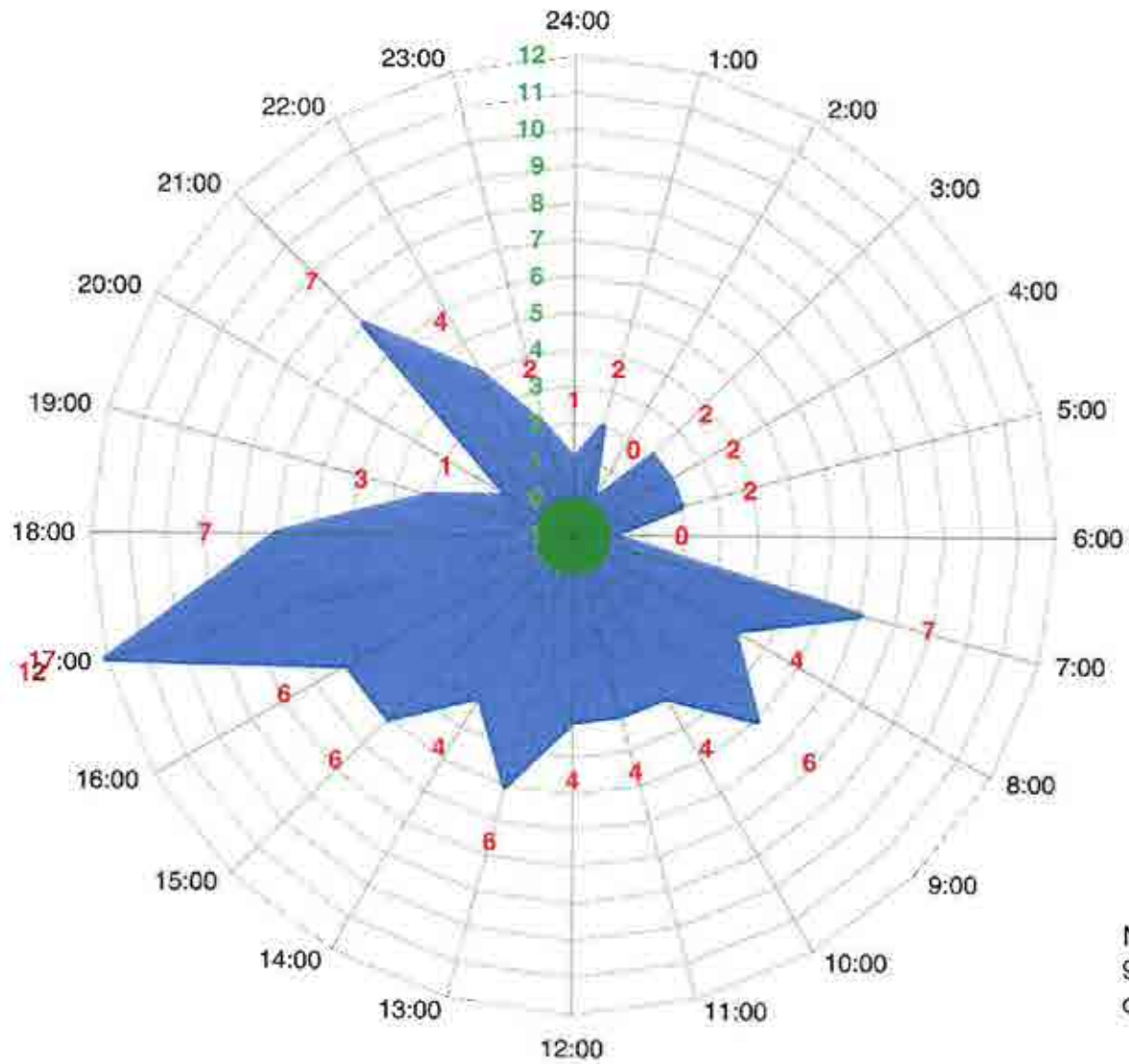

NOTE:
9:00 displays the number of crashes occurring from 8:00:00 to 8:59:59.

_irongate [2004-2008]

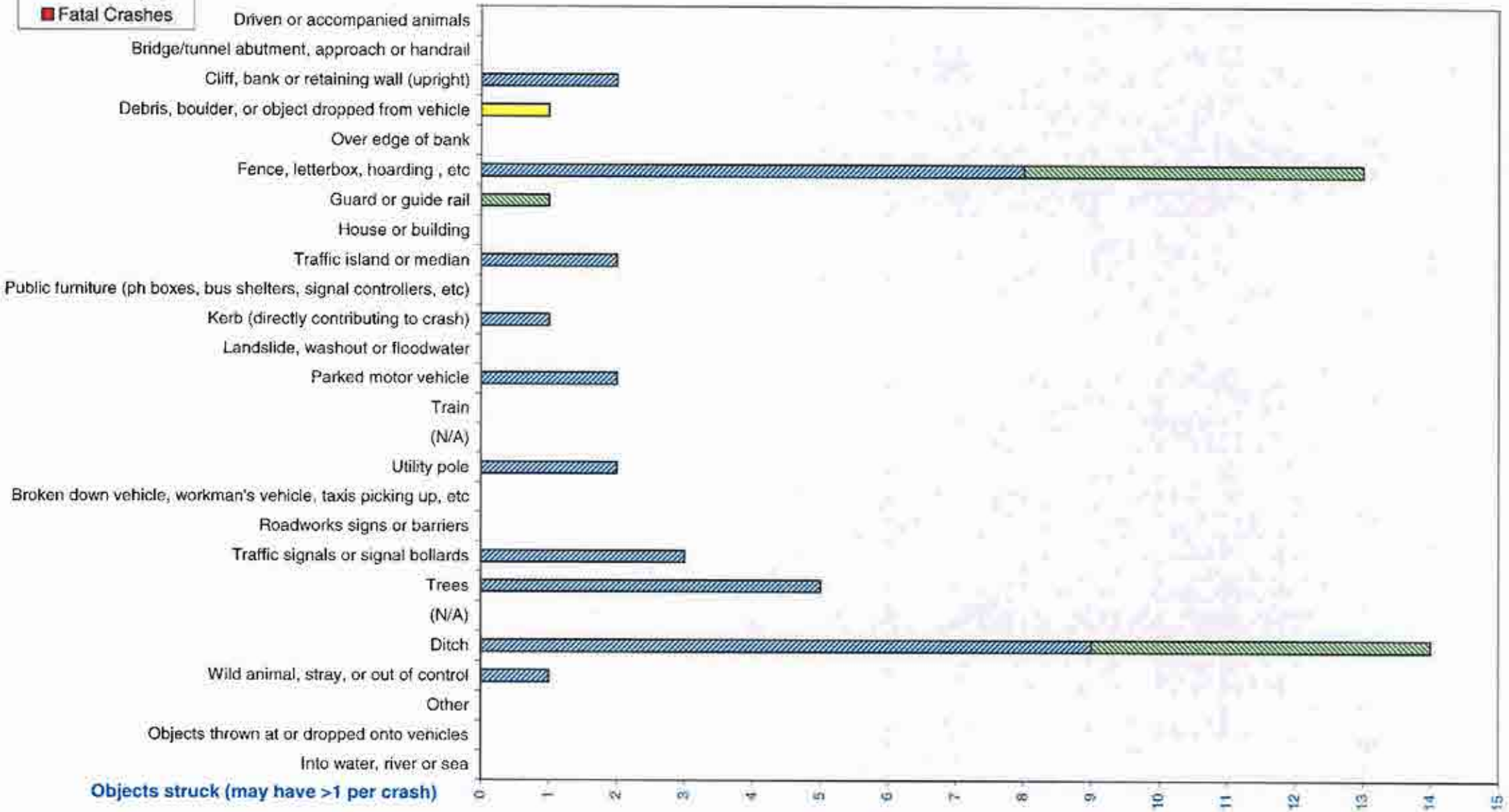

_irongate [2004-2008]

- Bright sun
- Overcast
- Twilight
- Dark

Brightness of sky

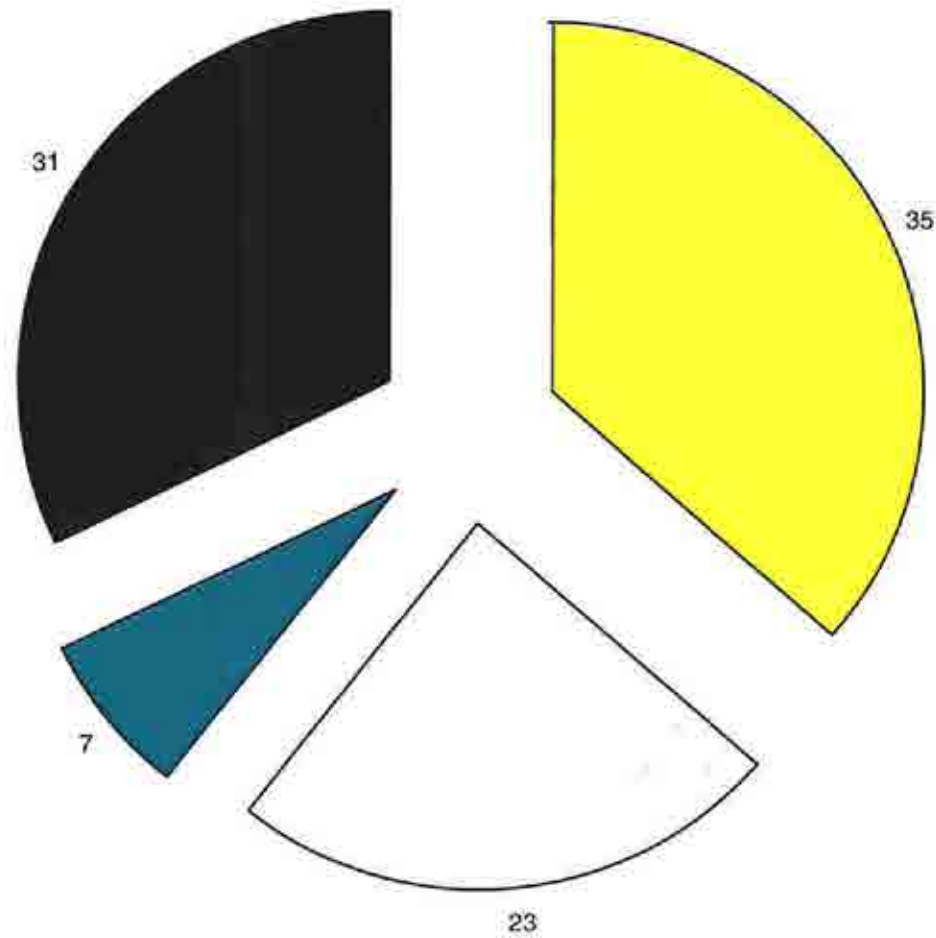

_irongate [2004-2008]

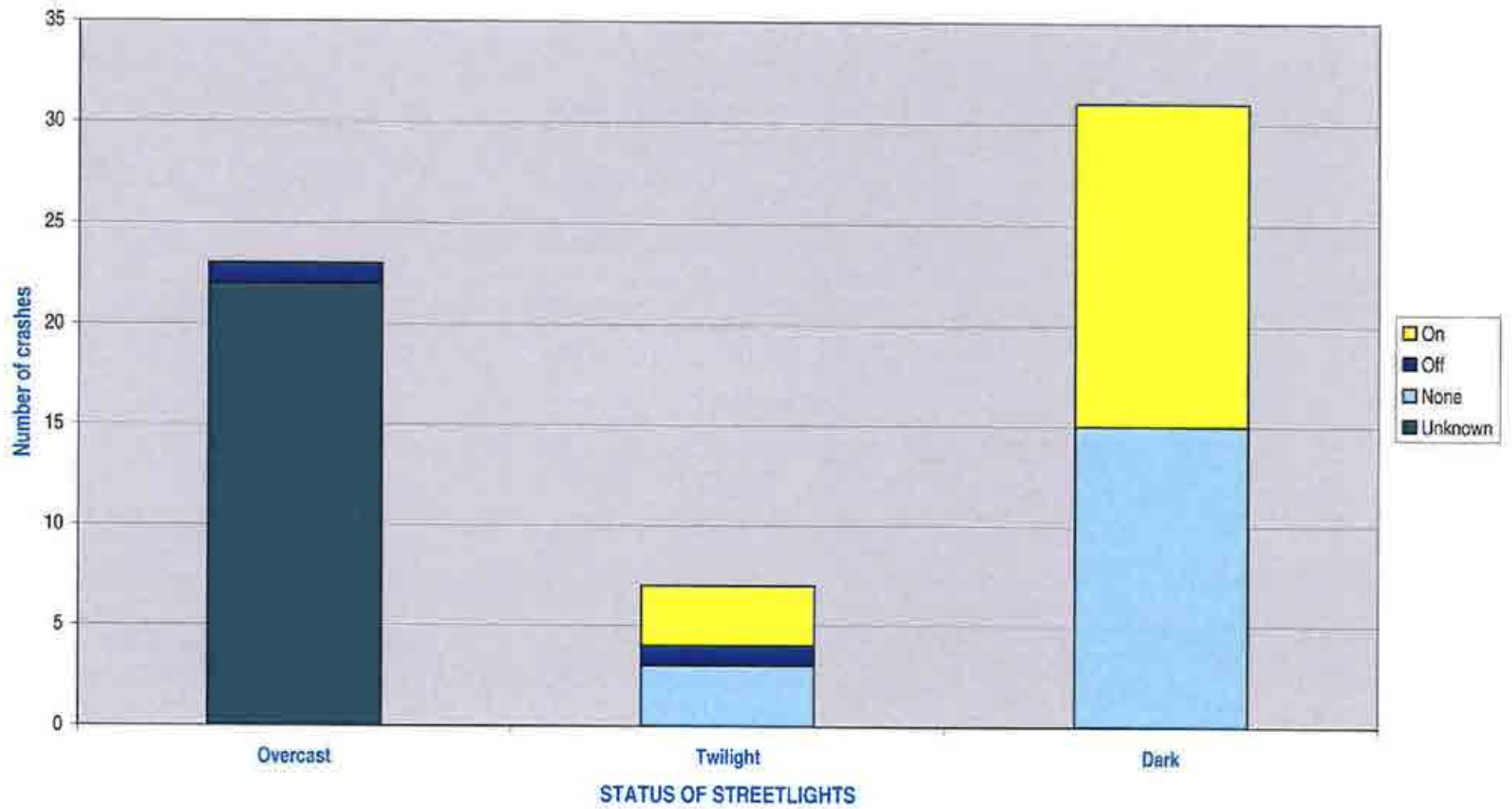

_irongate [2004-2008]

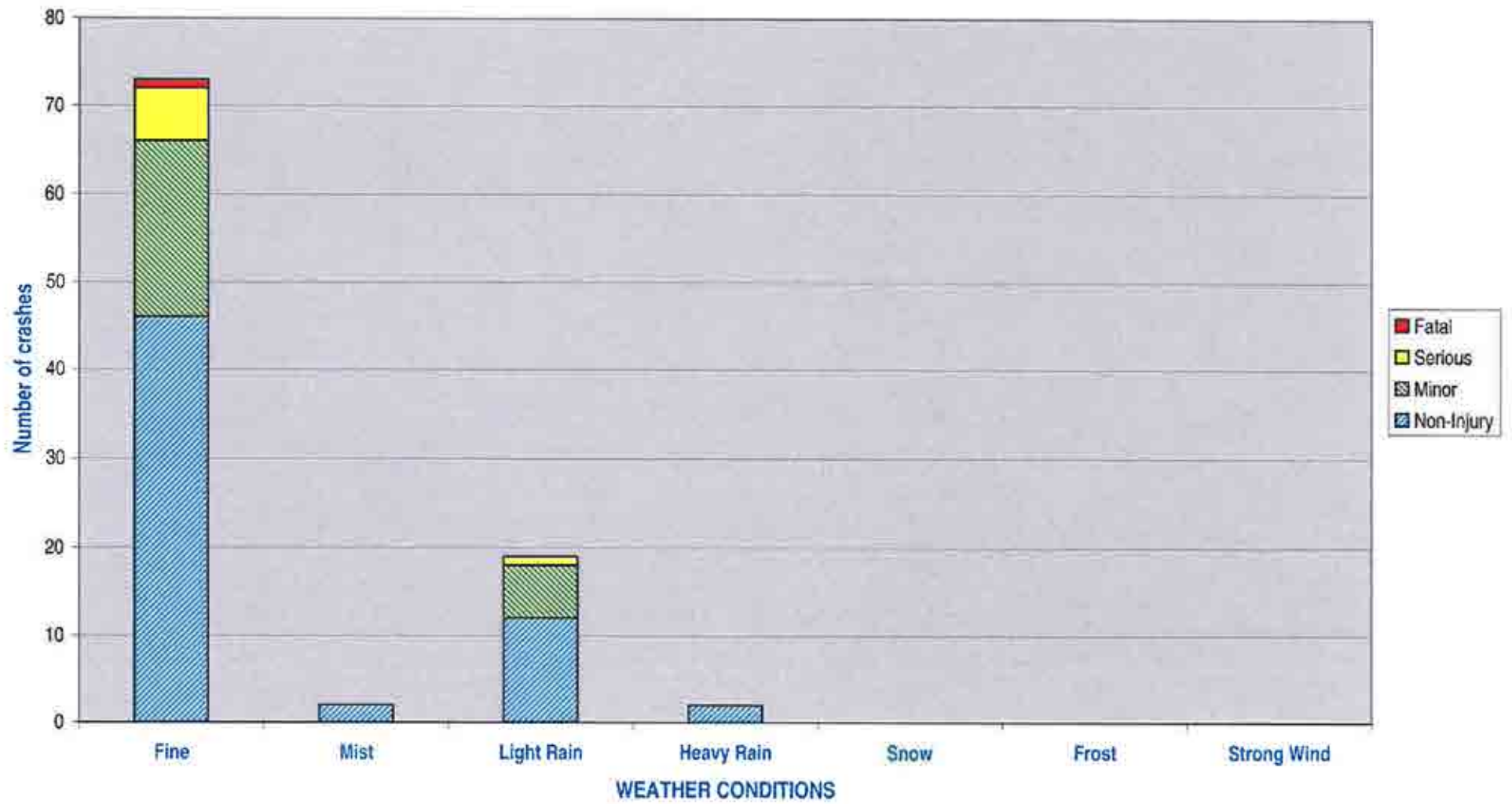

ORIGINAL SIZE A3
DO NOT SCALE - IF IN DOUBT, ASK

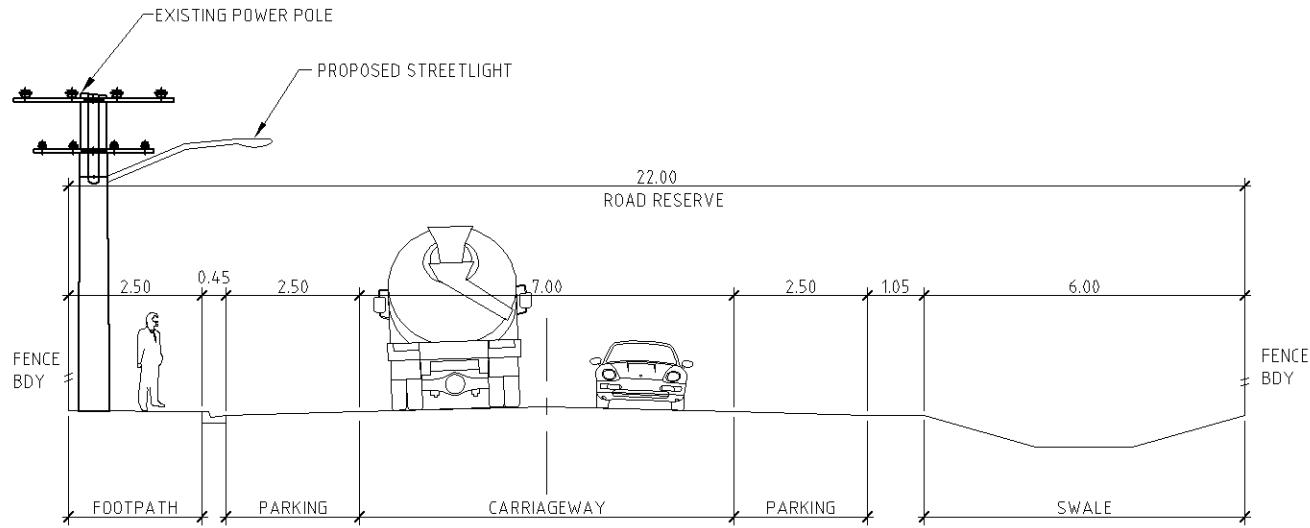

STAGE 1

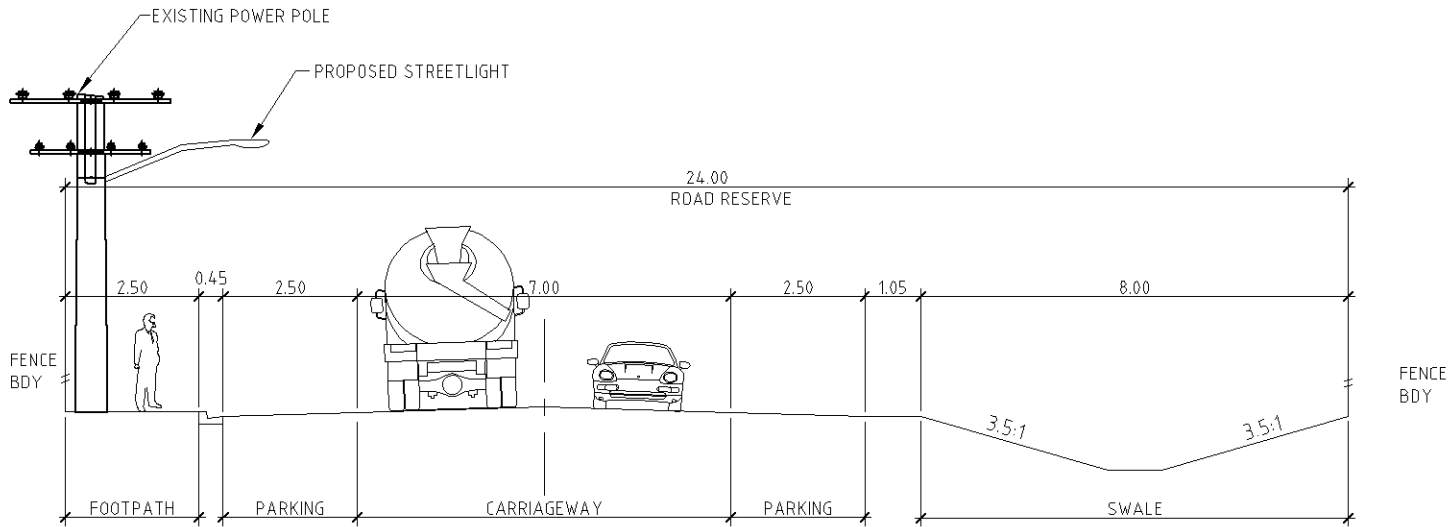

STAGE 2

NOT FOR CONSTRUCTION

REVISIONS		APP	DATE	APPROVED

SCALES (A3) 1:100		
	NAME	DATE
DESIGNED		
DESIGN CHECK		
DRAWN	R TAYLOR	06/09
DRAWING CHECK		
APPROVED	T GRACE	06/09



HASTINGS DISTRICT COUNCIL

HASTINGS DISTRICT COUNCIL
IRONGATE INDUSTRIAL PLAN CHANGE
TYPICAL COSS SECTION

IRONGATE ROAD

Status Stamp	FOR CONSULTATION		
Date Stamp	12/06/2009		
Drawing No.	Sheet No.	Rev.	
Z1462302	C01	C	



Hastings District Council
Irongate Industrial Plan Change

Rough Order Costs Summary
Transportation Network Improvements

	Irongate Road	Maraekakaho Road	Maraekakaho Road / Irongate Road Intersection	Marakakaho Road / York Road Intersection	Link Road	Link Road / Irongate Road Intersection	Link Road / York Road Intersection	Internal Access Corridor
Stage 1	\$460,000.00	\$50,000.00	\$625,000.00	\$500,000.00	Not required	Not required	Not required	\$168,000.00
Stage 2	\$525,00.00	Not required	Not required	Not required	\$1,465,000.00	\$340,000.00	\$330,000.00	Not required
Total	\$985,000.00	\$50,000.00	\$625,000.00	\$500,000.00	\$1,465,000.00	\$340,000.00	\$330,000.00	\$168,000.00

NOTES

- The rough order costs are considered to have an accuracy of +/- 30%.
- All rough order costs exclude land purchase (with the exception of the internal access corridor) and swale construction.
- Provision for stormwater is 5.6% of the total rough order costs.
- Provision for general is 5% of total rough order costs, provision for contingency is 20% of total rough order costs and provision for professional services is 15% of total rough order costs.
- The rough order costs do not include any provision for land purchase costs for the Link Road from Irongate Road to York Road or for the turning head required on Irongate Road.

- The rough order costs for the upgrade of Irongate Road is based on the accepted concept design solution as shown on the cross section drawing attached.
- There have been two rough order costs completed for the Link Road. These are for a design outcome based on a 9m wide carriageway with no footpaths, parking or cycle lanes and a design outcome based on a 14m wide kerb to kerb carriageway. The greater of the rough order costs (14m wide kerb to kerb design solution) has been included in the rough order costs summary table.
- The rough order costs for the Maraekakaho Road / Irongate Road round-a-bout does not include any provision for land purchase costs. It is understood that the Council has completed a valuation for these costs that can be included as considered appropriate.
- The rough order cost for the internal access corridor is based on the assumed land purchase costs for a 16m wide x 208m long area only at \$50.00 / m². The cost associated with the construction of any access or road within this internal access corridor will be the responsibility of the developer.
- The rough order cost included for Maraekakaho Road is for the extension of the culvert in the Irongate Stream. This will enable sufficient width for a dedicated cycleway and flush median to be constructed through this narrower section of the road. It has been determined that elsewhere there is currently sufficient carriageway width along Maraekakaho Road for provision of a dedicated cycleway and a flush median. No costings have therefore been provided for the widening of Marakakaho Road.
- The rough order costs for the upgrade of the Maraekakaho Road / York Road intersection are provisional only. Performance monitoring of this intersection as the development proceeds may identify requirements for improvement works. This provisional cost is based on a comparison of the revised rough order costs for the Link Road intersections and the 1999 OPUS SAR for this intersection.

This report has been prepared for the benefit of Hastings District Council. No liability is accepted by this company or any employee or sub-consultant of this company with respect to its use by any other person

**MWH**

Z1079701

18-May-09

Industrial Expansion**Rough Order Schedule Of Quantities****Irongate - 3Leg Tee Junction @ York**Prepared By: **K. Kiriona**

Item	Description	Unit	Quantity	Rate	Amount
1	<u>General</u>				
1.1	General	LS			\$13,000.00
1.2	Contingency	LS			\$50,000.00
2	<u>Stormwater Pipe Works</u>				
2.1	Construct sumps, leads and manholes	LS	1	15,200.00	\$15,200.00
3	<u>Islands</u>				
3.1	Construct splitter island	LS	1	5,000.00	\$5,000.00
4	<u>Kerb and Channel</u>				
4.1	Construct non-mountable kerb and channel	m	0	40.00	\$0.00
5	<u>Pavement Works</u>				
5.1	Undercut shoulders	cu m	152	10.00	\$1,522.50
5.2	Localised undercut to waste.	cu m	20	25.00	\$500.00
5.3	Supply & place make up metal.	cu m	20	50.00	\$1,000.00
5.4	Excavate existing pavement metals to stockpile	cu m	426	5.00	\$2,129.25
5.5	Excavate to waste	cu m	334		
5.6	Backfill and compact saved pavement metals	cu m	426	8.00	\$3,406.80
5.7	Supply and compact straighthaul material	cu m	278	12.00	\$3,333.60
5.8	Cement stabilise existing subgrade metals	sq.m	1,356	7.00	\$9,492.00
5.9	Supply and compact 150mm M5 basecourse material	sq.m	3,793	15.00	\$56,895.00
6	<u>First Coat & A.C. Seal</u>				
6.1	Preparation of surface	sq.m	0	0.10	\$0.00
6.2	Bitumin; Supply & place 180/200 binder	L	0	1.50	\$0.00
6.3	Supply and place grade 3 sealing chips	sq.m	0	1.00	\$0.00
6.4	Supply and place grade 5 sealing chips	sq.m	0	1.00	\$0.00
6.5	Mix 20 Asphaltic cement paving	sq.m	3,793	30.00	\$113,790.00
6.6	Extra sweeping of surplus chips	ea	1	1,000.00	\$1,000.00
7	<u>Unscheduled Items</u>				
7.1	Land Purchase (includes "The Property Group" fees)			Not included	
7.2	Street Lighting and provide private power supply.	L.S.	4	2,000.00	\$8,000.00
7.3	Roadmarking, R.P.M's & all road signs (including new directional signs)	L.S.			\$1,000.00
7.4	Cost share to lower telecom cables	L.S.			\$0.00
7.5	Cost share to lower power cables	L.S.			\$0.00
7.6	Install LINZ Survey Standard	L.S.			\$0.00
8	<u>Professional Services Fees</u>	L.S.			\$42,790.37
CONTRACT TOTAL				\$	\$328,059.52

Assumptions & Exclusions

Land purchase not included
Stormwater costs = 5.6% of total
Contingency = 20% of total
General = 5% of total
PS fees = 15% of total



Z1079701

18-May-09

Industrial Expansion

Rough Order Schedule Of Quantities

Irongate - Link Road, 9m no kerb

Prepared

K.Kiriona

By:

Item	Description	Unit	Quantity	Rate	Amount
1	General				
1.1	General	LS			\$36,000.00
1.2	Contingency	LS			\$145,000.00
2	Stormwater Pipe Works				
2.1	Construct sumps, leads and manholes	LS	1	43,900.00	\$43,900.00
3	Traffic Islands Infill				
3.1	Construct paving.	sq.m	Part of	30.00	
3.2	Supply topsoil for islands	sq.m	intersection	15.00	
3.3	Service lane median	sq.m	treatments	25.00	
4	Kerb and Channel				
4.1	Construct non-mountable kerb and channel	m	0	40.00	\$0.00
5	Pavement Works				
5.1	Remove existing kerbing.	m	0	10.00	\$0.00
5.2	Localised undercut to waste.	cu m	300	25.00	\$7,500.00
5.3	Supply & place make up metal.	cu m	300	50.00	\$15,000.00
5.4	Excavate existing pavement metals to stockpile	cu m	0	15.00	\$0.00
5.5	Excavate to waste	cu m	5,418	20.00	\$108,356.00
5.6	Backfill and compact saved pavement metals	cu m	0	20.00	\$0.00
5.7	Supply and compact straighthaul material	cu m	1,894	60.00	\$113,616.00
5.8	Cement stabilise 250mm depth	sq.m	9,468	7.00	\$66,276.00
5.9	Supply and compact 150mm M5 basecourse material	sq.m	9,468	15.00	\$142,020.00
6	First Coat & A.C. Seal				
6.1	Preparation of surface	sq.m	9,468	0.10	\$946.80
6.2	Bitumin; Supply & place 180/200 binder	L	17,989	1.50	\$26,983.80
6.3	Supply and place grade 3 sealing chips	sq.m	9,468	1.00	\$9,468.00
6.4	Supply and place grade 5 sealing chips	sq.m	9,468	1.00	\$9,468.00
6.5	Mix 20 Asphaltic cement paving	sq.m	0	30.00	\$0.00
6.6	Extra sweeping of surplus chips	ea	1	5,000.00	\$5,000.00
7	Unscheduled Items				
7.1	Land Purchase (includes fees)		Not included		
7.2	Street Lighting	each	15	2,000.00	\$30,000.00
7.3	Roadmarking, R.P.M's & all road signs (including new directional signs)	L.S.			\$2,000.00
7.4	Service Relocation - Telecom	L.S.			\$25,000.00
7.5	Service Relocation - Power	L.S.			\$25,000.00
7.6	Install LINZ Survey Standard	L.S.			\$5,000.00
7.7	Beautification/landscaping	L.S.			\$10,000.00
8	Professional Services Fees	L.S.			\$122,480.19
CONTRACT TOTAL				\$	\$949,014.79

Assumptions & Exclusions

Land purchase not included
 Swale construction not included
 Assumed seal width = 9
 Stormwater costs = 5.6% of total
 Contingency = 20% of total
 General = 5% of total
 PS fees = 15% of total



Z1079701
18-May-09

Industrial Expansion		Rough Order Schedule Of Quantities			
Irongate - Link Road, 14m kerb to kerb		Prepared		K.Kiriona	
		By:			
Item	Description	Unit	Quantity	Rate	Amount
1	General				
1.1	General	LS			\$55,000.00
1.2	Contingency	LS			\$225,000.00
2	Stormwater Pipe Works				
2.1	Construct sumps, leads and manholes	LS	1	67,600.00	\$67,600.00
3	Traffic Islands Infill				
3.1	Construct paving.	sq.m	Part of	30.00	
3.2	Supply topsoil for islands	sq.m	intersection	15.00	
3.3	Service lane median	sq.m	treatments	25.00	
4	Kerb and Channel				
4.1	Construct non-mountable kerb and channel	m	2,104	40.00	\$84,160.00
5	Pavement Works				
5.1	Remove existing kerbing.	m	0	10.00	\$0.00
5.2	Localised undercut to waste.	cu m	350	25.00	\$8,750.00
5.3	Supply & place make up metal.	cu m	350	50.00	\$17,500.00
5.4	Excavate existing pavement metals to stockpile	cu m	0	15.00	\$0.00
5.5	Excavate to waste	cu m	7,048	20.00	\$140,968.00
5.6	Backfill and compact saved pavement metals	cu m	0	20.00	\$0.00
5.7	Supply and compact straighthaul material	cu m	2,946	60.00	\$176,736.00
5.8	Cement stabilise 250mm depth	sq.m	14,728	7.00	\$103,096.00
5.9	Supply and compact 150mm M5 basecourse material	sq.m	14,728	15.00	\$220,920.00
6	First Coat & A.C. Seal				
6.1	Preparation of surface	sq.m	14,728	0.10	\$1,472.80
6.2	Bitumin; Supply & place 180/200 binder	L	27,983	1.50	\$41,974.80
6.3	Supply and place grade 3 sealing chips	sq.m	14,728	1.00	\$14,728.00
6.4	Supply and place grade 5 sealing chips	sq.m	14,728	1.00	\$14,728.00
6.5	Mix 20 Asphaltic cement paving	sq.m	0	30.00	\$0.00
6.6	Extra sweeping of surplus chips	ea	1	5,000.00	\$5,000.00
7	Unscheduled Items				
7.1	Land Purchase (includes fees)	sq.m		0.00	\$0.00
7.2	Street Lighting	each	15	2,000.00	\$30,000.00
7.3	Roadmarking, R.P.M's & all road signs (including new directional signs)	L.S.			\$2,000.00
7.4	Service Relocation - Telecom	L.S.			\$25,000.00
7.5	Service Relocation - Power	L.S.			\$25,000.00
7.6	Install LINZ Survey Standard	L.S.			\$5,000.00
7.7	Beautification/landscaping	L.S.			\$10,000.00
8	Professional Services Fees	L.S.			\$189,695.04
CONTRACT TOTAL				\$	\$1,464,328.64

Assumptions & Exclusions

Land purchase not included
 Assumed seal width = 14
 Stormwater costs = 5.6% of total
 Contingency = 20% of total
 General = 5% of total
 PS fees = 15% of total

**MWH**

Z1079701

18-May-09

Industrial Expansion**Rough Order Schedule Of Quantities****Irongate - 3Leg Tee @ Link / Irongate**Prepared By: **K. Kiriona**

Item	Description	Unit	Quantity	Rate	Amount
1	<u>General</u>				
1.1	General	LS			\$13,000.00
1.2	Contingency	LS			\$52,000.00
2	<u>Stormwater Pipe Works</u>				
2.1	Construct sumps, leads and manholes	LS	1	15,700.00	\$15,700.00
3	<u>Islands</u>				
3.1	Construct splitter island.	LS	1	5,000.00	\$5,000.00
4	<u>Kerb and Channel</u>				
4.1	Construct non-mountable kerb and channel	m	100	40.00	\$4,000.00
5	<u>Pavement Works</u>				
5.1	Undercut shoulders	cu m	152	10.00	\$1,522.50
5.2	Localised undercut to waste.	cu m	20	25.00	\$500.00
5.3	Supply & place make up metal.	cu m	20	50.00	\$1,000.00
5.4	Excavate existing pavement metals to stockpile	cu m	317	15.00	\$4,754.25
5.5	Excavate to waste	cu m	589	20.00	\$11,781.00
5.6	Backfill and compact saved pavement metals	cu m	317	20.00	\$6,339.00
5.7	Supply and compact straighthaul material	cu m	424	60.00	\$25,416.00
5.8	Cement stabilise existing subgrade metals	sq.m	1,683	7.00	\$11,781.00
5.9	Supply and compact 150mm M5 basecourse material	sq.m	3,796	15.00	\$56,940.00
6	<u>First Coat & A.C. Seal</u>				
6.1	Preparation of surface	sq.m	3,796	0.10	\$379.60
6.2	Bitumin; Supply & place 180/200 binder	L	7,212	1.50	\$10,818.60
6.3	Supply and place grade 3 sealing chips	sq.m	3,796	1.00	\$3,796.00
6.4	Supply and place grade 5 sealing chips	sq.m	3,796	1.00	\$3,796.00
6.5	Mix 20 Asphaltic cement paving	sq.m	0	25.00	\$0.00
6.6	Extra sweeping of surplus chips	ea	1	1,000.00	\$1,000.00
7	<u>Unscheduled Items</u>				
7.1	Land Purchase (includes "The Property Group" fees)			Not included	
7.2	Street Lighting and provide private power supply.	L.S.	4	2,000.00	\$15,000.00
7.3	Roadmarking, R.P.M's & all road signs (including new directional signs)	L.S.			\$1,000.00
7.4	Cost share to lower telecom cables	L.S.			\$0.00
7.5	Cost share to lower power cables	L.S.			\$50,000.00
7.6	Install LINZ Survey Standard	L.S.			\$0.00
8	<u>Professional Services Fees</u>	L.S.			\$44,328.59
CONTRACT TOTAL				\$	\$339,852.54

Assumptions & Exclusions

Land purchase not included
Stormwater costs = 5.6% of total
Contingency = 20% of total
General = 5% of total
PS fees = 15% of total



Z1462302

16-Jun-09

Industrial Expansion - Stage 2

Rough Order Schedule Of Quantities

Irongate - Irongate Rd upgrade , no ints

Prepared

K.Kiriona

By:

Item	Description	Unit	Quantity	Rate	Amount
1	General				
1.1	General	LS			\$18,000.00
1.2	Contingency	LS			\$70,000.00
2	Stormwater Pipe Works				
2.1	Construct sumps, leads and manholes	LS	1	23,600.00	\$23,600.00
3	Traffic Islands Infill				
3.1	Construct paving.	sq.m	Part of	40.00	
3.2	Supply topsoil for islands	sq.m	intersection	15.00	
3.3	Service lane median	sq.m	treatments	25.00	
4	Kerb and Channel and Footpath				
4.1	Construct non-mountable kerb and channel	m	420	40.00	\$16,800.00
4.2	Construct 2.5m Wide Concrete Footpath	sq.m	1,050	45.00	\$47,250.00
5	Pavement Works				
5.1	Remove existing kerbing.	m	0	10.00	\$0.00
5.2	Localised undercut to waste.	cu m	50	25.00	\$1,250.00
5.3	Supply & place make up metal.	cu m	50	50.00	\$2,500.00
5.4	Excavate existing pavement metals to stockpile	cu m	315	15.00	\$4,725.00
5.5	Excavate to waste	cu m	1,197	20.00	\$23,940.00
5.6	Backfill and compact saved pavement metals	cu m	315	20.00	\$6,300.00
5.7	Supply and compact straighthaul material	cu m	441	60.00	\$26,460.00
5.8	Cement stabilise imported/backfilled metals 250mm deep	sq.m	5,040	8.00	\$40,320.00
5.9	Supply and compact 150mm M5 basecourse material	sq.m	5,040	15.00	\$75,600.00
5.10	Construct grass berm/swale adjacent to carriageway		Not included		
6	First Coat & A.C. Seal				
6.1	Preparation of surface	sq.m	5,040	0.10	\$504.00
6.2	Bitumin; Supply & place 180/200 binder	L	9,576	1.50	\$14,364.00
6.3	Supply and place grade 3 sealing chips	sq.m	5,040	1.00	\$5,040.00
6.4	Supply and place grade 5 sealing chips	sq.m	5,040	1.00	\$5,040.00
6.5	Mix 20 Asphaltic cement paving	sq.m	0	30.00	\$0.00
6.6	Extra sweeping of surplus chips	ea	1	2,000.00	\$2,000.00
7	Unscheduled Items				
7.1	Land Purchase (includes fees)		Not included		
7.2	Street Lighting	each	12	2,000.00	\$24,000.00
7.3	Roadmarking, R.P.M's & all road signs (including new directional signs)	L.S.	1	5,000.00	\$5,000.00
7.4	Service Relocation - Telecom	L.S.	1	10,000.00	\$10,000.00
7.5	Service Relocation - Power	L.S.	1	15,000.00	\$15,000.00
7.6	Install LINZ Survey Standard	L.S.	1	1,500.00	\$1,500.00
7.7	Beautification/landscaping	L.S.	1	5,000.00	\$5,000.00
8	Professional Services Fees	L.S.			\$67,000.00
CONTRACT TOTAL				\$	\$511,193.00

Assumptions & Exclusions

Land purchase not included

Swale construction not included

Stormwater costs = 5.6% of total

General = 5% of total

Contingency = 20% of total

PS fees = 15% of total

Assumed full reconstruction for 12m sealed width, kerb & channel & footpath one side only



Z1462302

16-Jun-09

Industrial Expansion - Stage 1

Rough Order Schedule Of Quantities

Irongate - Irongate Rd upgrade , no ints

Prepared

K.Kiriona

By:

Item	Description	Unit	Quantity	Rate	Amount
1	General				
1.1	General	LS			\$18,000.00
1.2	Contingency	LS			\$70,000.00
2	Stormwater Pipe Works				
2.1	Construct sumps, leads and manholes	LS	1	21,300.00	\$21,300.00
3	Traffic Islands Infill				
3.1	Construct paving.	sq.m	Part of	40.00	
3.2	Supply topsoil for islands	sq.m	intersection	15.00	
3.3	Service lane median	sq.m	treatments	25.00	
4	Kerb and Channel and Footpath				
4.1	Construct non-mountable kerb and channel	m	280	40.00	\$11,200.00
4.2	Construct 2.5m Wide Concrete Footpath	sq.m	700	45.00	\$31,500.00
5	Pavement Works				
5.1	Remove existing kerbing.	m	0	10.00	\$0.00
5.2	Localised undercut to waste.	cu m	50	25.00	\$1,250.00
5.3	Supply & place make up metal.	cu m	50	50.00	\$2,500.00
5.4	Excavate existing pavement metals to stockpile	cu m	315	15.00	\$4,725.00
5.5	Excavate to waste	cu m	1,197	20.00	\$23,940.00
5.6	Backfill and compact saved pavement metals	cu m	315	20.00	\$6,300.00
5.7	Supply and compact straighthaul material	cu m	441	60.00	\$26,460.00
5.8	Cement stabilise imported/backfilled metals 250mm deep	sq.m	5,040	8.00	\$40,320.00
5.9	Supply and compact 150mm M5 basecourse material	sq.m	5,040	15.00	\$75,600.00
5.10	Construct grass berm/swale adjacent to carriageway		Not included		
6	First Coat & A.C. Seal				
6.1	Preparation of surface	sq.m	5,040	0.10	\$504.00
6.2	Bitumin; Supply & place 180/200 binder	L	9,576	1.50	\$14,364.00
6.3	Supply and place grade 3 sealing chips	sq.m	5,040	1.00	\$5,040.00
6.4	Supply and place grade 5 sealing chips	sq.m	5,040	1.00	\$5,040.00
6.5	Mix 20 Asphaltic cement paving	sq.m	0	30.00	\$0.00
6.6	Extra sweeping of surplus chips	ea	1	2,000.00	\$2,000.00
7	Unscheduled Items				
7.1	Land Purchase (includes fees)		Not included		
7.2	Street Lighting	each	8	2,000.00	\$16,000.00
7.3	Roadmarking, R.P.M's & all road signs (including new directional signs)	L.S.	1	2,500.00	\$2,500.00
7.4	Service Relocation - Telecom	L.S.	1	5,000.00	\$5,000.00
7.5	Service Relocation - Power	L.S.	1	10,000.00	\$10,000.00
7.6	Install LINZ Survey Standard	L.S.	1	1,500.00	\$1,500.00
7.7	Beautification/landscaping	L.S.	1	5,000.00	\$5,000.00
8	Professional Services Fees	L.S.			\$60,000.00
CONTRACT TOTAL				\$	\$460,043.00

Assumptions & Exclusions

Land purchase not included

Swale construction not included

Stormwater costs = 5.6% of total

General = 5% of total

Contingency = 20% of total

PS fees = 15% of total

Assumed full reconstruction for 12m sealed width, kerb & channel & footpath one side only

Industrial Expansion		Rough Order Schedule Of Quantities			
Section 1 -Option 8b		Prepared		K Kiriona	
By:					
Item	Description	Unit	Quantity	Rate	Amount
1	<u>General</u>				
1.1	General	LS		50,000.00	\$50,000.00
1.2	Contingency	LS		20,000.00	\$20,000.00
2	<u>Stormwater Pipe Works</u>				
2.1	Construct sumps, leads and manholes	LS	1	29,000.00	\$29,000.00
2.2	Supply materials & construct culvert	LS	0	25,000.00	\$0.00
4	<u>Kerb, Island & berm works</u>				
4.1	Construct non-mountable kerb and channel	m	255	40.00	\$10,200.00
4.2	Construct splitter islands-(nib & concrete infill)	each	3	7,000.00	\$21,000.00
4.3	Construct central island	LS	1	25,000.00	\$25,000.00
4.4	Topsoil & sow berms behind kerbs	m2	510	4.00	\$2,040.00
5	<u>Pavement Works</u>				
5.1	Localised undercut to waste.	cu m	50	25.00	\$1,250.00
5.2	Supply & place make up metal.	cu m	50	50.00	\$2,500.00
5.3	Excavate existing pavement metals to stockpile	sq.m	2,520	5.00	\$12,600.00
5.4	Excavate to waste	sq.m	1,800	10.00	\$18,000.00
5.5	Backfill and compact saved pavement metals	sq.m	2,520	8.00	\$20,160.00
5.6	Supply and compact straighthaul material	sq.m	1,800	12.00	\$21,600.00
5.7	Cement stabilise imprted/backfilled metals, 250mm deep	sq.m	4,680	8.00	\$37,440.00
5.8	Supply and compact 150mm M5 basecourse material	sq.m	4,680	15.00	\$70,200.00
5.9	Construct grass berm/swale adjacent to carriageway		Not included		
6	<u>First Coat & A.C. Seal</u>				
6.1	Preparation of surface	sq.m	3,000	0.10	\$300.00
6.2	Bitumin; Supply & place 180/200 binder	L	5,700	1.50	\$8,550.00
6.3	Supply and place grade 3 sealing chips	sq.m	500	1.00	\$500.00
6.4	Supply and place grade 5 sealing chips	sq.m	500	1.00	\$500.00
6.5	Mix 20 Asphaltic cement paving	sq.m	2,500	30.00	\$75,000.00
6.6	Extra sweeping of surplus chips	ea	1	1,000.00	\$1,000.00
7	<u>Unscheduled Items</u>				
7.1	Land Purchase (includes fees, fencing)		Not included		
7.2	Street Lighting	sq.m		0.00	
7.3	Roadmarking, R.P.M's & all road signs (including new directional signs)	each	6	2,000.00	\$12,000.00
7.4	Service Relocation - Telecom	L.S.	1	5,000.00	\$5,000.00
7.5	Service Relocation - Power	L.S.	1	10,000.00	\$10,000.00
7.6	Install LINZ Survey Standard	L.S.	1	20,000.00	\$20,000.00
7.7	Install LINZ Survey Standard	L.S.	1	2,500.00	\$2,500.00
7.7	Beautification/landscaping	L.S.	1	5,000.00	\$5,000.00
7.8	Supply & install guardrailing to protect power poles	L.S.	1	5,000.00	\$5,000.00
7.8	Supply & install guardrailing to protect power poles	L.S.	0	10,000.00	\$0.00
7.9	Culvert Extension	L.S.	1	50,000.00	\$50,000.00
7.10	Supply & install guardrailing to protect culvert	L.S.	1	10,000.00	\$10,000.00
8	<u>Professional Services Fees</u>	L.S.			\$81,200.00
CONTRACT TOTAL				\$	\$622,540.00

Assumptions & Exclusions

Land Purchase not included
 Stormwater Costs 5.6% of total
 PS Fees 15% of total
 Construction of swales not included

ORIGINAL SIZE - A1
1:10000 (GRAPHIC SCALE - FOR GUIDANCE ONLY)



NOT FOR CONSTRUCTION

NO.	REVISIONS	DATE	BY	DESCRIPTION

Task	Name	Date
SURVEYED		
DESIGNED		
DESIGN CHECK		
DRAWN		
DRAWING CHECK		
APPROVED		



HASTINGS DISTRICT COUNCIL

IRONGATE INDUSTRIAL EXPANSION
IRONGATE ROAD - MARAKAKHO ROAD
ROUNDABOUT - OPTION 8b

Project Name	CONCEPTUAL		
Date	06/03/2008		
Scale	SCALE (A1) 1:100		
Sheet No.	21127503	Scale	C011
Revision			A

Hawke's Bay Irongate Industrial Area Modelling Report - Phase 1



Prepared by



March 2009

HAWKE'S BAY

Irongate Industrial Area Modelling



Prepared by **Matt Elery**
Transportation Analyst

Gabites Porter Consultants Ltd
Level 1, 138 Victoria Street
P O BOX 25 103

Reviewed by **David Hunter**
Senior Transport Engineer

Christchurch
New Zealand

Approved by **David Hunter**
Senior Transport Engineer

Telephone: +64 3 366 9871

Facsimile: +64 3 366 9870

Date: 16 March 2009

Reference: 4413

Status: Final

Revision: 2

CONTENTS

1. INTRODUCTION	1
2. ROAD NETWORKS	1
3. EXISTING INDUSTRIAL LAND USE	4
4. LOCAL AREA VALIDATION	6
4.1 General	6
4.2 Measures of Validity	6
4.3 Screenline Validation Results	7
4.4 Intersection Turning Movement (ITM) Validation	10
4.5 ITM Validation Results	10
5. MODELLING RESULTS	14

Tables

1. Irongate Existing Land Use	4
2. Model Traffic Flow Validation Guidelines	7
3. Irongate Network Validation	9
4. Intersection Turning Movement Validation Results	10

Figures

1. Hawke's Bay Base Road Network	2
2. Hawke's Bay Future Road Network	3
3. TRACKS zones distribution for Irongate	5
4. Irongate Screenline Locations	8
5. ITM Validation Morning Peak Period	11
6. ITM Validation Shopping Peak Period	12
7. ITM Validation Evening Peak Period	13

APPENDICES

- Appendix 1 Screenline Validation: Cordon Outputs
- Appendix 2 ITM Validation: Turnon Outputs
- Appendix 3 2009 Validated Base Model: Existing Irongate LU Only
 - 1. 2009 AM Peak Validated Base Traffic Volumes
 - 2. 2009 SH Peak Validated Base Traffic Volumes
 - 3. 2009 PM Peak Validated Base Traffic Volumes
 - 4. 2009 AM Peak Validated Base Level of Service
 - 5. 2009 SH Peak Validated Base Level of Service
 - 6. 2009 PM Peak Validated Base Level of Service

- Appendix 4 2016 Base Model: Existing Irongate LU Only
 - 1. 2016 AM Peak Base Traffic Volumes
 - 2. 2016 SH Peak Base Traffic Volumes
 - 3. 2016 PM Peak Base Traffic Volumes
 - 4. 2016 AM Peak Base Level of Service
 - 5. 2016 SH Peak Base Level of Service
 - 6. 2016 PM Peak Base Level of Service
- Appendix 5 2016 Future Model: Existing Irongate LU Only
 - 1. 2016 AM Peak With 5-leg RAB Traffic Volumes
 - 2. 2016 AM Peak With 5-leg RAB Traffic Volumes Change to Base
 - 3. 2016 SH Peak With 5-leg RAB Traffic Volumes
 - 4. 2016 SH Peak With 5-leg RAB Traffic Volumes Change to Base
 - 5. 2016 PM Peak With 5-leg RAB Traffic Volumes
 - 6. 2016 PM Peak With 5-leg RAB Traffic Volumes Change to Base
 - 7. 2016 AM Peak With 5-leg RAB Level of Service
 - 8. 2016 SH Peak With 5-leg RAB Level of Service
 - 9. 2016 PM Peak With 5-leg RAB Level of Service

1. INTRODUCTION

This report has been commissioned by MWHNZ Ltd on behalf of Hastings District Council and is intended to show the baseline traffic flows in the vicinity of the Irongate Industrial area in 2009 and 2016.

This report supersedes previous Irongate Industrial area reports provided by Gabites Porter Consultants which did not include existing land use on and adjacent to Irongate Road. The existing Irongate area land use has been incorporated into the modelling so as to more accurately represent current traffic flows.

The content of this report begins with local area validation around the Irongate area in a 2009 model. All changes made to the land use, zone system and road network during the validation process will be included in all other following models.

2. ROAD NETWORKS

The base road network used in the modelling is shown in **Figure 1** and the future road network with expressway extension is shown in **Figure 2**.

In the base network, Irongate Road is connected to Maraekakaho Road with a priority give way and there is a 4-leg roundabout at the Maraekakaho Road/Longlands Road/Paki Paki Road intersection.

In the future road network, the southern expressway extension has no connection to Irongate Road. Connection of the expressway extension to the Maraekakaho Road/Longlands Road/Paki Paki Road intersection, coloured orange, will be as a 5-leg roundabout. Irongate Road is straightened where it connects to Maraekakaho Road with a double approach give-way.

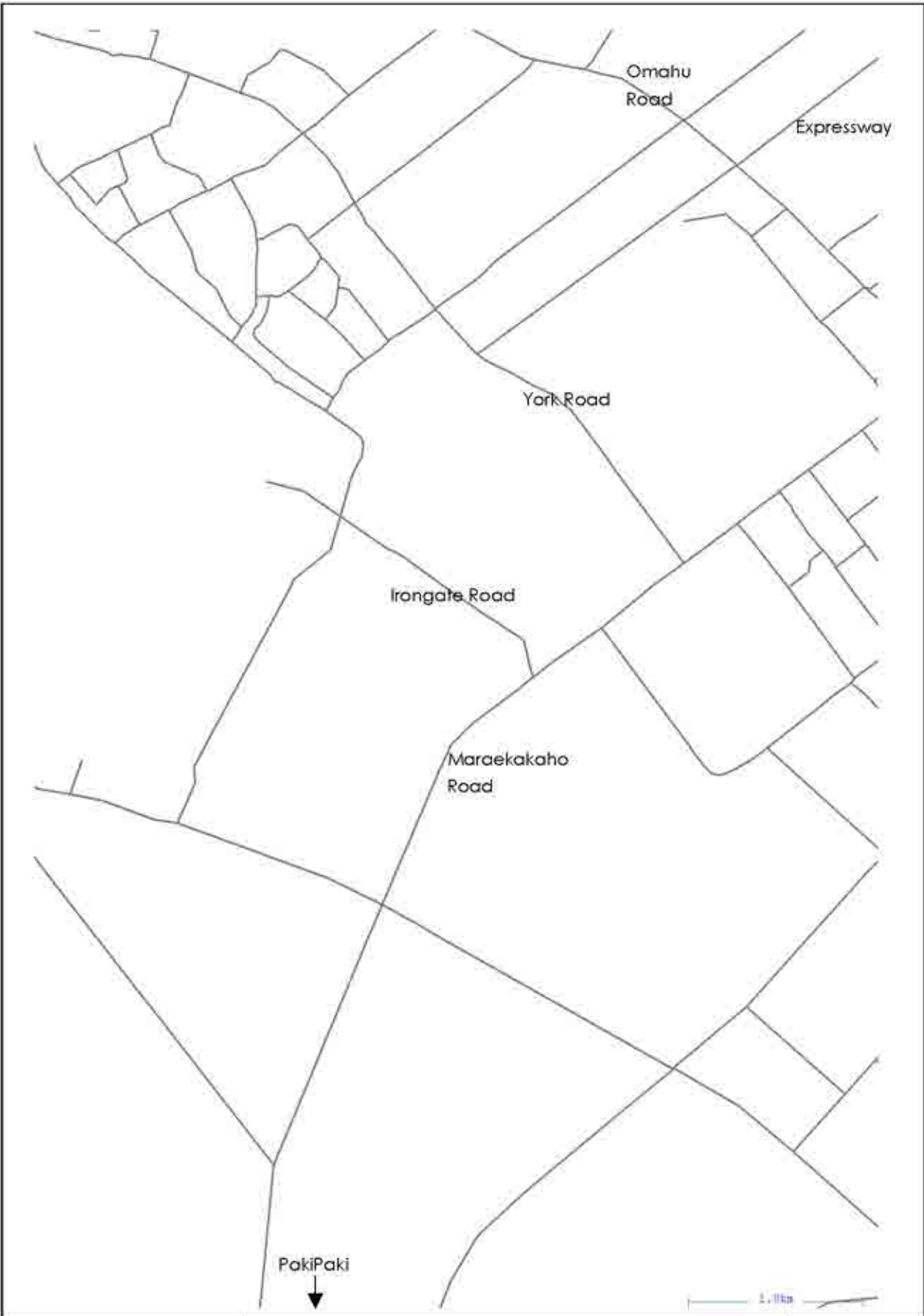

Hawke's Bay Irongate Modelling	Hawke's Bay Base Road Network	Figure 1
Gabites Porter Consultants		

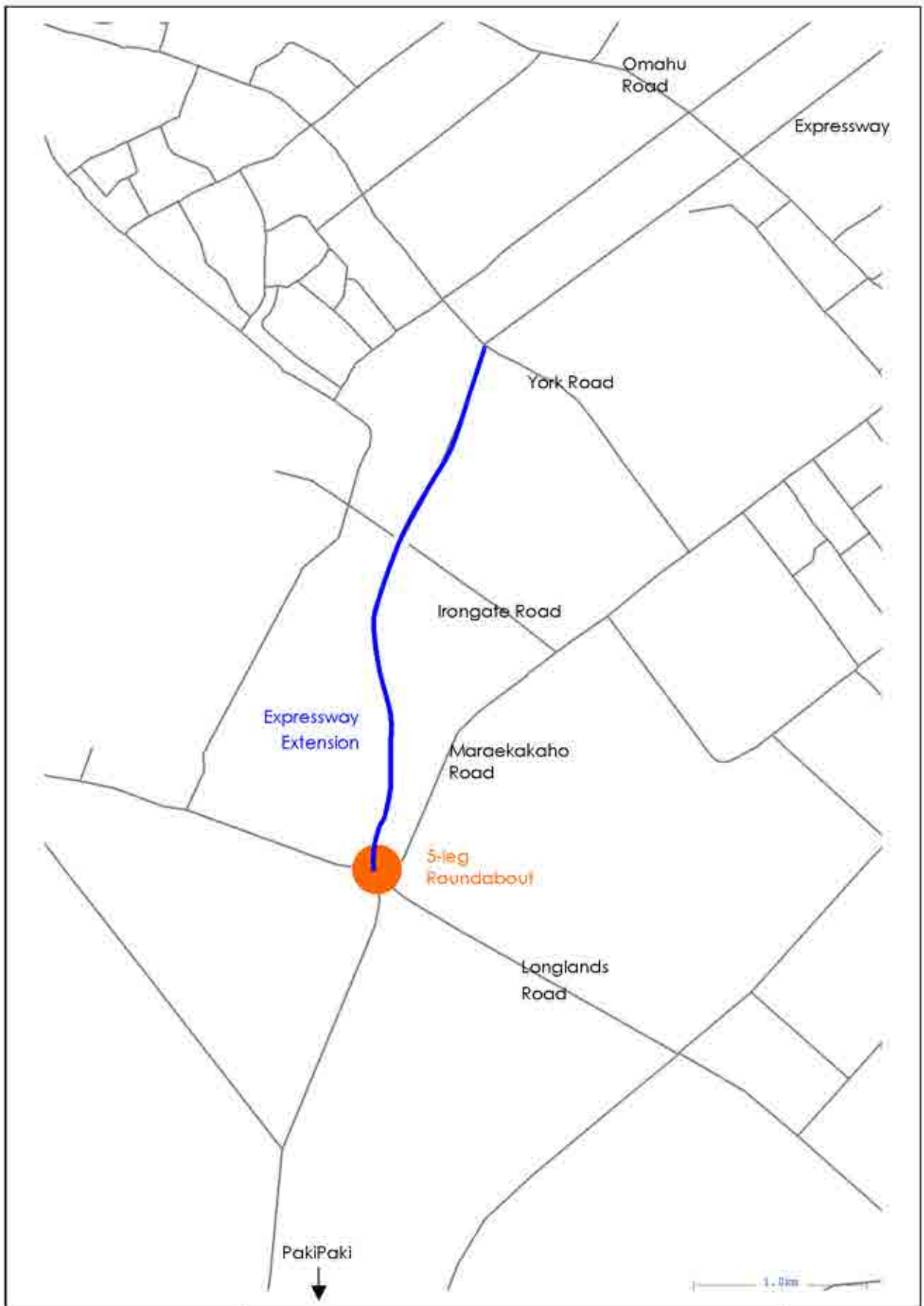

Hawke's Bay Irongate Modelling	Hawke's Bay Future Road Network	Figure 2
Gabites Porter Consultants		

3. EXISTING INDUSTRIAL LAND USE

Industrial land use at Omahu and Tomoana has not been adjusted from previous analyses. Irongate Road industrial area existing/current land use has been determined from aerial photographs and survey responses from the local businesses.

The zone system used for the modelling is shown in **Figure 3**. The boundaries and descriptions of each area were provided by MWH and are to be considered as existing land use.

The total number of jobs in the Irongate area was determined by counting the number of cars parked at each business as evident in aerial photographs. In addition, the three largest businesses were contacted and asked how many workers they employed. The job total for each business area was then divided into the seven job categories in the model by using the same proportional split as in other industrial areas in the model, namely the Port, Ahuriri, Onekawa, Omahu, Pandora, Tomoana, Whakatu and Awatoto. These job numbers were subsequently refined during the local area validation process, described in the next section, and are shown in **Table 1**.

Irongate Existing Land Use										
Zone	Size (Ha)	Level of Use	Job Type							
			AGR	MAN	WHO	RET	OFF	EDU	COM	TOT
152	3.7	Light	0	2	0	0	1	0	1	5
152	6.2	Light	0	4	1	1	2	0	1	12
156	2.7	Light	0	2	1	0	1	0	1	7
159	0.83	Light	0	12	10	2	8	1	4	46
160	7.9	Heavy	0	54	10	6	10	1	11	115
173	9.8	Heavy	1	56	11	7	11	1	12	120
174	7.5	Light	0	14	14	2	12	1	4	56
178	0.6	Light	0	1	0	0	1	0	0	4
Total	39.23		2	147	48	18	45	4	34	365

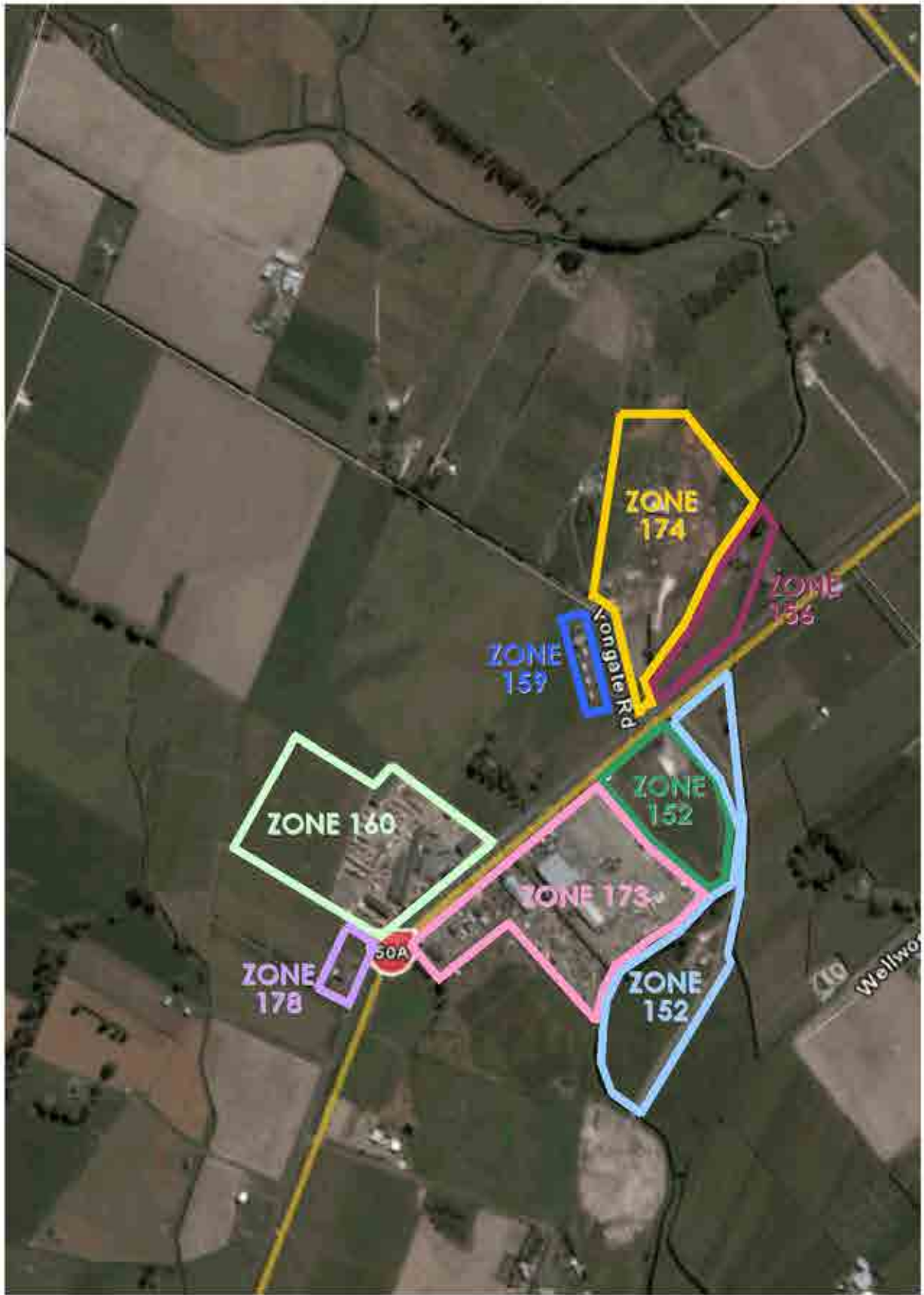

Hawke's Bay Irongate Modelling	TRACKS zones distribution for Irongate	Figure 3
Gabites Porter Consultants		

4. LOCAL AREA VALIDATION

4.1 General

A local area validation was carried out on the 2009 model to refine the model and replicate actual traffic flows as closely as practicable. 2009 intersection turning movements and all day traffic volumes from the past 10 years were supplied by MWH by which to compare to. These were then used to calculate actual traffic flows into and out of the intersections that will be used as spot counts and are shown in **Figure 4**.

4.2 Measures of Validity

Flow comparisons are tested using a number of statistical measures. Traffic counts were grouped into screenlines, and the following measures calculated.

- Comparisons of individual links;
- Comparisons of total trips over each screenline;
- Percentage difference; and statistical measures such as
- Correlation coefficient;
- % Root mean square, and
- GEH.

The correlation coefficient is a first order measure of the co-relation, using the formula:

$$P_{x,y} = \frac{\sum_{i=1}^n (x_i - \bar{x})(y_i - \bar{y})}{\sigma_x \sigma_y}$$

The GEH is a form of the Chi-squared statistic that incorporates both relative and absolute errors. It is designed to be more tolerant of the large percentage differences in lower flows. The form of the statistic is:

$$GEH = \sqrt{\frac{2(m-o)^2}{m+o}}$$

Where m is the modelled flow and o is the observed count.

The validation criteria used for this model were the Land Transport NZ Project Evaluation Manual (PEM) guidelines.

The consultants have relied on the PEM criteria to provide guidance in the validation of the model but have also indicated the model's level of validation to the UK criteria provided by the UK Design Manual for Roads and Bridges – Traffic Appraisal in Urban Areas Assignment Validation Acceptability Guidelines.

The Land Transport NZ Project Evaluation Manual (PEM) guidelines for overall validation are summarised in **Table 2**. The PEM looks for major link volumes (i.e. those carrying more than 30,000 VPD) to be within 20% of observed values and that the error tolerance for links with lower volumes is greater. As a matter of principle, screenline and individual count validation for this study should not exceed the guidelines expressed in the PEM.

Model Traffic Flow Validation Guidelines				Table 2
Screenline Totals				
Traffic Flow	± 10%			
Correlation Coefficient	>0.85 generally			
	>0.95 preferred			
GEH	<4 in most instances			
GEH on Counts	<5	<7	<10	<12
(modified for 1 hr flows only)	60%	80%	95%	100%
Total Counts				
% RMS	<30 generally			

The UK Design Manual criteria are described as follows for greater than 85% of links:

1. For flows <700 Vehicles per hour = ± 100 Vehicles per hour
2. For flows 700-2700 Vehicles per hour = ± 15%
3. For flows >2700 Vehicles per hour = ± 400 Vehicles per hour
4. GEH <5

4.3 Screenline Validation Results

Based on the PEM model fitness guidelines in **Table 2**, this report is convinced that the modelled traffic flows closely replicate actual counts for all designated screenlines during the morning, shopping and evening peak periods.

The validation statistics for each cordon are summarised in **Table 3** for the morning, shopping and evening peak periods.

CORDON, as part of the TRACKS suite, was used to execute the screenline validation process. The output files produced by CORDON is attached as **Appendix 1**.

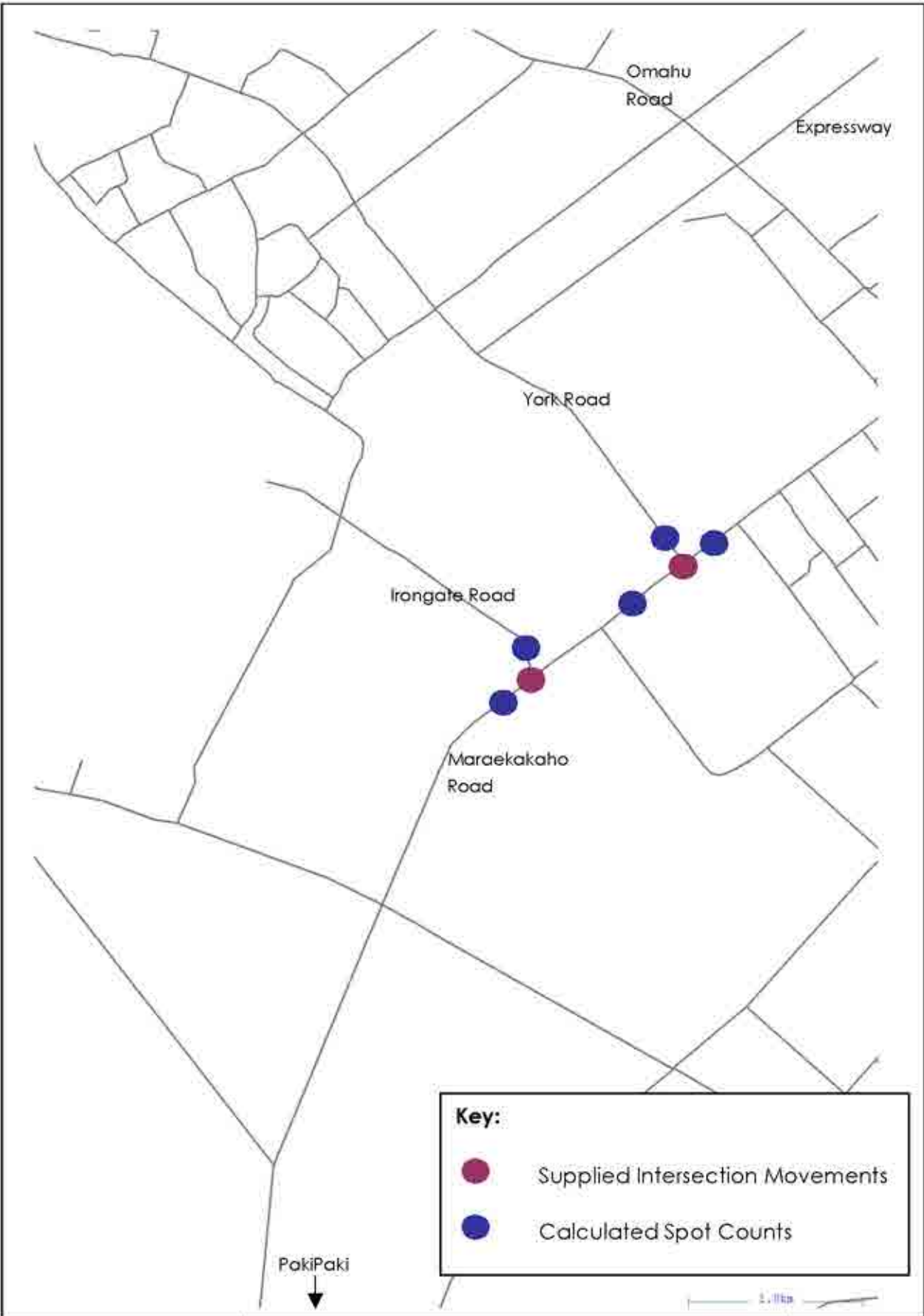

Hawke's Bay Irongate Modelling	Irongate Screenline Locations	Figure 4
Gabites Porter Consultants		

Irongate Network Validation

Table 3

Morning Peak Period				
Count	3320			
Volume	3322			
Change	2			
%	100			
Correlation Coefficient	0.999			
%RMS	4.90			
GEH Total	0.0			
GEH Link Grouping	<5	<7	<10	<12
% in GEH Group	100	100	100	100
Shopping Peak Period				
Count	2987			
Volume	2889			
Change	-98			
%	97			
Correlation Coefficient	0.997			
%RMS	5.56			
GEH Total	1.8			
GEH Link Grouping	<5	<7	<10	<12
% in GEH Group	100	100	100	100
Evening Peak Period				
Count	3173			
Volume	3342			
Change	169			
%	105			
Correlation Coefficient	0.978			
%RMS	13.95			
GEH Total	3.0			
GEH Link Grouping	<5	<7	<10	<12
% in GEH Group	80	100	100	100
UK Criteria				
For flows <700 vph = ± 100 vph	100%			
For flows 700-2700 vph = ± 15%	83%			
For flows >2700 vph = ± 400 vph	N/A			
GEH <5	93%			

4.4 Intersection Turning Movement (ITM) Validation

Gabites Porter has been supplied with actual traffic flow data on 2 intersections along Maraekakaho Road;

- Maraekakaho Rd / Irongate Rd (Mk/Ir)
- Maraekakaho Rd / York Rd (Mk/Yk)

As with the screenline validation process, validating the intersection turning movements is usually done with two statistical measures, the correlation coefficient (>0.8) and % RMS (<30). It is sometimes required that the turning movements are generally within $\pm 10\%$ or 30 vehicles for very tight validation, otherwise $\pm 30\%$ or 30 vehicles is considered an acceptable level of tolerance.

4.5 ITM Validation Results

Table 4 shows the synthesis of all turning movement data for morning, shopping and evening peak periods of the day. Refer to **Appendix 2** for the output files for the intersection turning movement validation process.

Intersection Turning Movement Validation Results									Table 4
Statistics		Total Observed Movements	Total Modelled Movements	%age of Observed	Correlation Coefficient				Turning Movement %RMS
					Turning Movement	Inbound Links	Outbound Links	2-Way Links	
	Mk/Ir	734	692	-5.7%	0.999	0.999	0.999	0.999	7.477
	Mk/Yk	1255	1301	3.7%	0.993	1.000	1.000	1.000	10.172
SP	Mk/Ir	723	710	-1.8%	0.999	1.000	1.000	1.000	5.238
	Mk/Yk	1100	1077	-2.1%	0.997	0.999	0.998	0.999	6.429
PM	Mk/Ir	722	720	-0.3%	0.998	1.000	0.999	0.999	9.141
	Mk/Yk	1211	1297	7.1%	0.988	0.996	0.993	0.998	14.302

For each of AMP, SHP and PMP, of the 36 turning movements assessed 7 movements were outside the $\pm 10\%$ or 30 vehicle criteria, with 4 of these only marginally outside, and only 2 movements outside the $\pm 30\%$ or 30 vehicle criteria. This shows general meeting of this criteria and is therefore considered acceptable.

Turning movement validation plots for each intersection are shown in **Figure 5** to **Figure 7**.

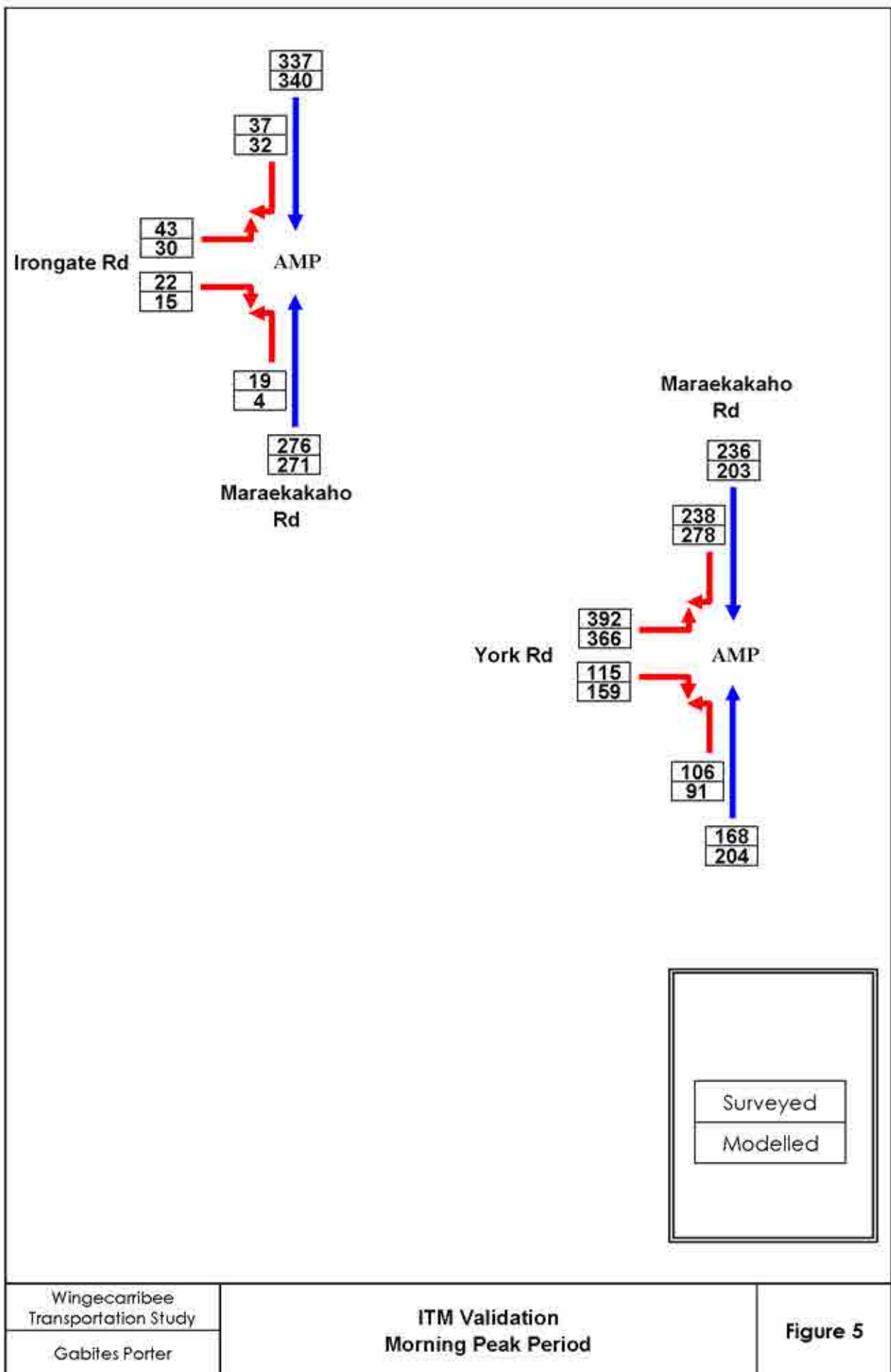

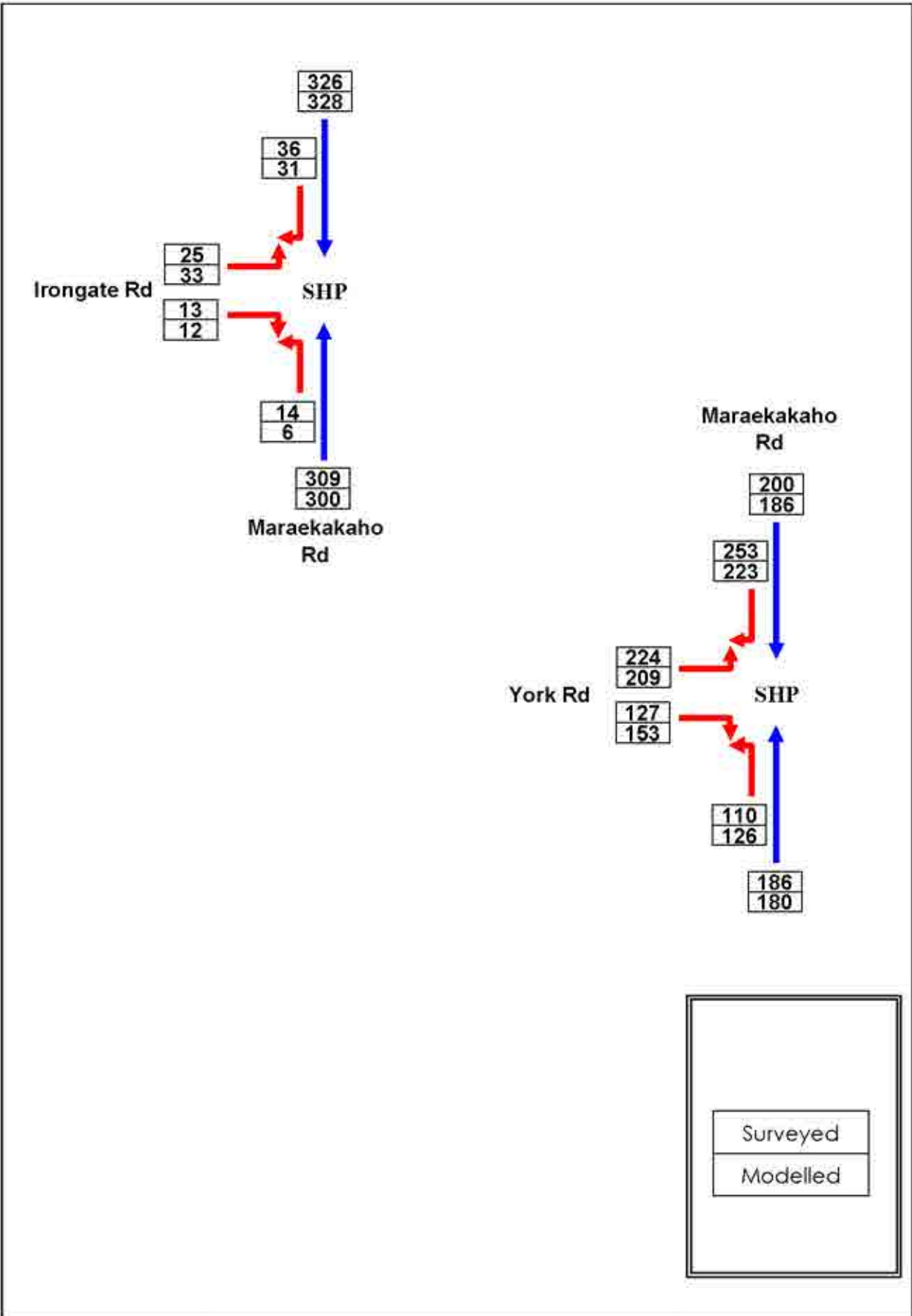

Wingecarribee Transportation Study	ITM Validation Shopping Peak Period	Figure 6
Gabites Porter		

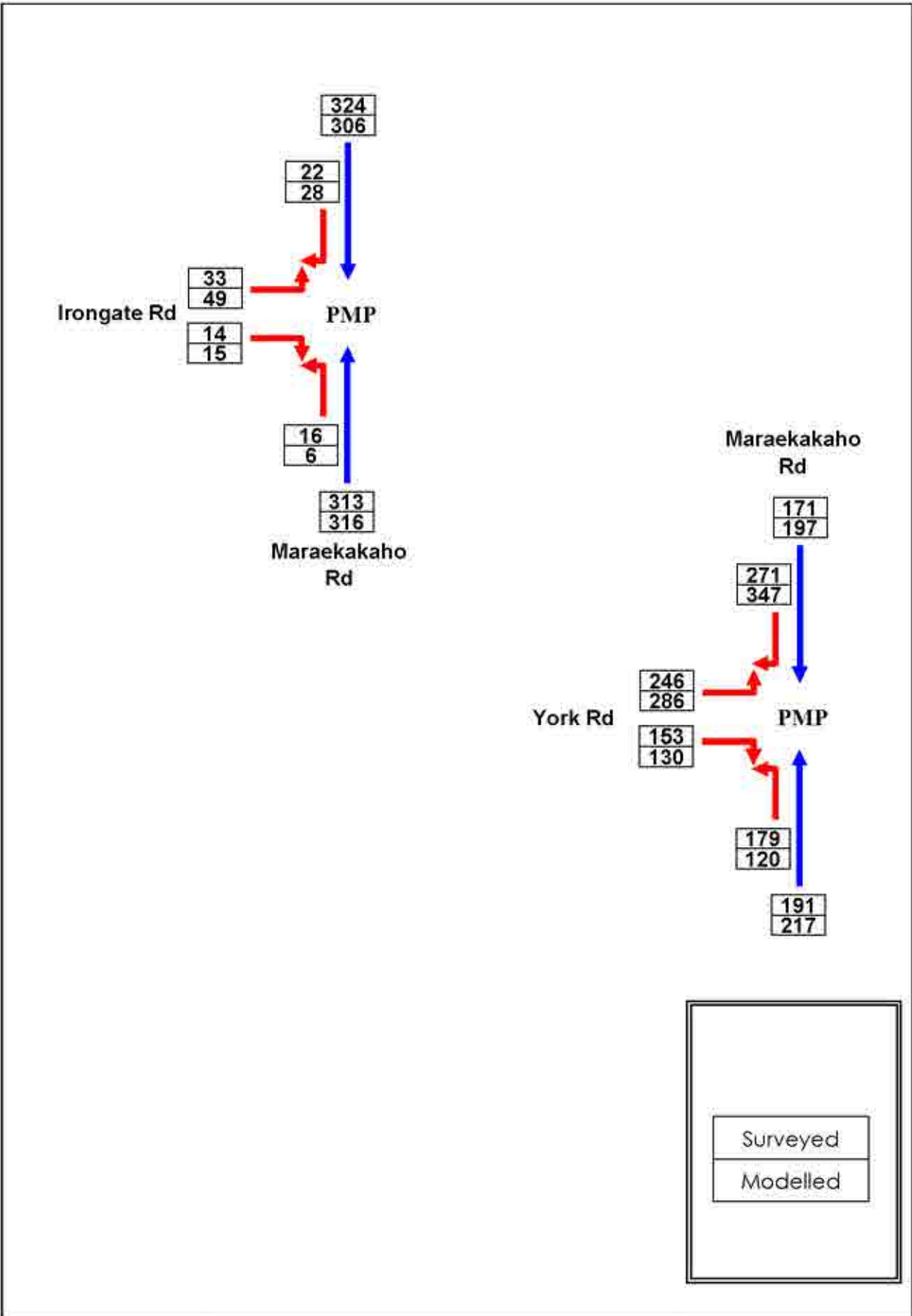

Wingecarribee Transportation Study	ITM Validation Evening Peak Period	Figure 7
Gabites Porter		

5. MODELLING RESULTS

Outputs for traffic volumes and levels of service (LOS) can be seen in **Appendix 3** through **Appendix 5**.

Appendix 3 contains the 2009 validated base network (existing Irongate land use only) volume plots in **App 3 – 1** through **App 3 – 3** and levels of service in **App 3 – 4** through **App 3 – 6**.

Appendix 4 has the 2016 base network (existing Irongate land use only) volume plots in **App 4 – 1** through **App 4 – 3** and levels of service plots in **App 4 – 4** through **App 4 - 6**.

Appendix 5 has the 2016 future network (existing Irongate land use only) with expressway extension and 5-leg roundabout volume plots in **App 5 - 1** through **App 5 - 6** and levels of service plots in **App 5 – 7** through **App 5 - 9**.

REFERENCES

- Akcelik Akcelik, R., Travel Time Functions for Transportation Planning Purposes. Australian Road Research, 21 (3), September 1991.
- Akcelik Akcelik, R., The Highway Capacity Manual Formula for Signalised Intersections. ITE Journal, March 1988, Vol. 58, No. 3.
- Fisk Fisk, C.S., Link Travel Time Functions for Traffic Assignment.
Department of Civil Engineering, University of Auckland.
- Fisk Fisk, C.S., and Tan H.H., Delay Analysis for Priority Intersections.
Department of Civil Engineering, University of Auckland, 1989.
- Gabites Porter Performance Analysis of Priority Intersections - A Practitioner's Guide, September 1991
- Gabites Porter Hawkes Bay Irongate Industrial Area Modelling Report, January 2009
- Land Transport NZ Project Evaluation Manual, October 2005.

APPENDICES



APPENDIX 1

Screenline Validation: Cordon Outputs

Morning Peak Period

```

+-----+
| TRACKS TRACKS TRACKS TRACKS TRACKS TR |
| TRACKS +-----+ TRACKS |
| S TRACKS | S TRACKS |
| KS TRACK | KS TRACK |
| CKS TRAC | CKS TRAC |
| ACKS TRAI | ACKS TRA |
| RACKS TR | RACKS TR |
| TRACKS T | TRACKS T |
| TRACKS | TRACKS |
| S TRACKS+-----+S TRACKS |
| KS TRACKS TRACKS TRACKS TRACKS |
+-----+
| TRACKS Licenced to |
| Gabites Porter |
| at : Christchurch, N.Z. |
+-----+
Build Date : 30/04/08 01:30
Parameter version : V5.20
    
```

Network Period Factor : 1.000
 Cordon Period Factor : 1.000
 GEH Period Factor : 1.000

CSV Output File :

Cordon Data File : IRONAM.EXDHAWKES BAY REGIONAL TRAFFIC STUDY - 2009
 Loaded Network : HMO9NL.EXD NAPLER ROADING STUDY 2009 AMP ALL VEHS
 4756 Links in network

Cordon Number : 1
 Description : 1 IRONGATE SCREENLINE (NB/EB FIRST)

NODE1	NODE2	FORWARD			BACK			TOTAL		
		COUNT	VOLUME	%	COUNT	VOLUME	%	COUNT	VOLUME	%
1580	3032	295.	276	19.93.6	359.	356	-3.99.2	632	654.	96.6
1630	4088	297.	296	-1.99.7	363.	363	0.100.0	659	660.	99.8
4088	4089	560.	571	11.102.0	474.	482	8.101.7	1034.	1053.	101.8
1581	3032	65.	46	-19.70.8	56.	37	-19.66.1	83	121.	68.6
1616	4088	507.	526	19.103.7	344.	369	25.107.3	895	895.	105.2

Number of links = 5 Number of forward links = 5 Number of back links = 5

TOTALS	FORWARD	BACK	TOTALS
COUNT	1724.	1596.	3320.
VOLUME	1715.	1607.	3322.
CHANGE	-9.	11.	2.
%	99.	101.	100.

CORREL. .999
 COEFF. .997
 %RMS 5.03 5.10 4.90
 I^2 .998 .995 .997
 GEH .2 .3 .0
 GEH <5 <7 <10 <12 >12
 # 5 5 5 5 0
 % 100.0 100.0 100.0 100.0 .0

CORDON terminated successfully

Shopping Peak Period

```

+-----+
| TRACKS TRACKS TRACKS TRACKS TRACKS TR |
| TRACKS +-----+ TRACKS |
| S TRACKS | | S TRACKS |
| KS TRACK | Program : CORDON | KS TRACK |
| CKS TRAC | Version : V7.08 | CKS TRAC |
| ACKS TRA | | ACKS TRA |
| RACKS TR | Date run : 06-Mar-09 | RACKS TR |
| TRACKS T | Time run : 09:22:46 | TRACKS T |
| TRACKS | Platform : Win 95/NT | TRACKS |
| S TRACKS+-----+ S TRACKS |
| KS TRACKS TRACKS TRACKS TRACKS TRACKS |
+-----+
| TRACKS Licenced to |
| Gabites Porter |
| at : Christchurch, N.Z. |
+-----+
Build Date : 30/04/08 01:30
Parameter version : V5.20

```

Network Period Factor : 1.000
 Cordon Period Factor : 1.000
 GEH Period Factor : 1.000

CSV Output File :

Cordon Data File : IRONSH.EXDHAWKES BAY REGIONAL TRAFFIC STUDY
 Loaded Network : HS09NL.EXD NAPLIER ROADING STUDY 2009 SHOPPING ALL V
 4756 Links in network

Cordon Number : 1
 Description : 1 IRONGATE SCREENLINE (NB/EB FIRST)

NODE1	NODE2	COUNT	%	FORWARD	BACK	TOTAL	CHANGE	%	GEH				
1580	3032	323.	-17.	94.7	339.	340	1.00.3	662.	646	-16.	97.6	.6	MARAEKAKAHO RD (STH IRONGATE)

1630	4088	315.	307	-8.	97.5	345.	340	-5.	98.6	660.	647	-13.	98.0	.5	MARAEKAKAHO RD (BTW IRONGATE/YORK)
4088	4089	410.	390	-20.	95.1	453.	410	-43.	90.5	863.	800	-63.	92.7	2.2	MARAEKAKAHO RD (NTH YORK)
1581	3032	38.	45	7.	118.4	50.	38	-12.	76.0	88.	83	-5.	94.3	.5	IRONGATE RD
1616	4088	351.	363	12.	103.4	363.	350	-13.	96.4	714.	713	-1.	99.9	.0	YORK RD

Number of links = 5 Number of forward links = 5 Number of back links = 5

TOTALS	FORWARD	BACK	TOTALS
COUNT	1437.	1550.	2987.
VOLUME	1411.	1478.	2889.
CHANGE	-26.	-72.	-98.
%	98.	95.	97.
CORREL.			
COEFF.	.996	.994	.997
%RMS	5.35	7.54	5.56
r^2	.992	.989	.995
GEH	.7	1.9	1.8

GEH	<5	<7	<10	<12	>12
#	5	5	5	5	0
%	100.0	100.0	100.0	100.0	.0

CORDON terminated successfully

Evening Peak Period

```

+-----+
| TRACKS TRACKS TRACKS TRACKS TRACKS TR |
| TRACKS +-----+ TRACKS |
| S TRACKS |
| KS TRACK | Program : CORDON | KS TRACK |
| CKS TRAC | Version : V7.08 | CKS TRAC |
| ACKS TRAI |
| RACKS TR | Date run : 06-Mar-09 | RACKS TR |
| TRACKS T | Time run : 09:29:30 | TRACKS T |
| TRACKS | Platform : Win 95/NT | TRACKS |
| S TRACKS+-----+S TRACKS |
| KS TRACKS TRACKS TRACKS TRACKS TRACKS |
+-----+
| TRACKS Licenced to |
| Gabites Porter |
| at : Christchurch, N.Z. |
+-----+

```

Build Date : 30/04/08 01:30
Parameter version : V5.20

Network Period Factor : 1.000
Cordon Period Factor : 1.000
GEH Period Factor : 1.000

CSV Output File :

Cordon Data File : IRONPM.EXDHawks Bay Evening Peak Model - 4-6pm - 2009 Landuse
 Loaded Network : HEONL.EXD NAPLER ROADING STUDY 2009 PMP ALL VEHs
 4756 Links in network

Cordon Number : 1
 Description : 1 IRONGATE SCREENLINE (NB/EB FIRST)

MODEL NODE2	COUNT	FORWARD VOLUME	CHANGE	%	COUNT	BACK VOLUME	CHANGE	%	COUNT	TOTAL VOLUME	CHANGE	%	GEH
1580 3032	329.	323	-6.	98.2	338.	322	-16.	95.3	667.	645	-22.	96.7	.9
1630 4088	358.	337	-21.	94.1	335.	327	-8.	97.6	693.	664	-29.	95.8	1.1
4088 4089	437.	503	66.	115.1	442.	545	103.	123.3	879.	1048	169.	119.2	5.4
1581 3032	47.	66	19.	140.4	38.	35	-3.	92.1	85.	101	16.	118.8	1.7
1616 4088	399.	416	17.	104.3	450.	468	18.	104.0	849.	884	35.	104.1	1.2

Number of links = 5 Number of forward links = 5 Number of back links = 5

TOTALS	FORWARD	BACK	TOTALS
COUNT	1570.	1603.	3173.
VOLUME	1645.	1697.	3342.
CHANGE	75.	94.	169.
%	105.	106.	105.
CORREL.			
COEFF.	.980	.975	.978
%RMS	11.79	16.55	13.95
r^2	.960	.951	.957
GEH	1.9	2.3	3.0
GEH <5	<7	<10	<12 >12
#	4	5	5
%	80.0	100.0	100.0
			.0

CORDON terminated successfully

ITM Validation: Turnon Outputs

Morning Peak Period

```

+-----+
| TRACKS - 06-Mar-09 @ 09:18:11                                     Gabites Porter |
|                                                                 Christchurch, N.Z. |
+-----+

```

```

+-----+
| TRACKS TRACKS TRACKS TRACKS TRACKS TRACKS TRACKS TR |
| TRACKS +-----+ TRACKS |
| S TRACKS| |S TRACKS |
| KS TRACK| Program : TURNON |KS TRACK |
| CKS TRAC| Version : V7.01 |CKS TRAC |
| ACKS TRA| |ACKS TRA |
| RACKS TR| Date run : 06-Mar-09 |RACKS TR |
| TRACKS T| Time run : 09:18:11 |TRACKS T |
| TRACKS | Platform : Win 95/NT | TRACKS |
| S TRACKS+-----+S TRACKS |
| KS TRACKS TRACKS TRACKS TRACKS TRACKS TRACKS |
+-----+
| TRACKS Licenced to |
| Gabites Porter |
| at : Christchurch, N.Z. |
+-----+

```

Build Date : 30/04/08 01:30
Parameter version : V5.20

Loaded Network : HM09NL.EXD

```

Intersection Number : 1
Description          : IRONGATE RD AND MARAEKAKAHO RD
Number of incoming links : 3
Count Factor        : 1.0000
Volume Factor       : 1.0000

```

Node	In Count	In Volume	%Change	Out Count	Out Volume	%Change
1580-3032	0	0	276	271	19	4
1612-3032	337	340	0	0	37	32
1581-3032	22	15	43	30	0	0

```

Correlation Coefficient : .999
% RMS : 7.477

```

Node	In Count	In Volume	%Change	Out Count	Out Volume	%Change
1580-3032	295	275	93.2	359	355	98.9
1612-3032	374	372	99.5	319	301	94.4
1581-3032	65	45	69.2	56	36	64.3

```

Correlation Coefficient : In .999 Out .999 Both .999

```

```

Intersection Number : 2
Description          : YORK RD AND MARAEKAKAHO RD
Number of incoming links : 3
Count Factor        : 1.0000
Volume Factor       : 1.0000

```

Node	In Count	In Volume	%Change	Out Count	Out Volume	%Change
1630-4088	0	0	168	204	106	91
4089-4088	236	203	0	0	238	278
1616-4088	115	159	392	366	0	0

```

Correlation Coefficient : .993
% RMS : 10.172

```

Node	In Count	In Volume	%Change	Out Count	Out Volume	%Change
1630-4088	274	295	107.7	351	362	103.1
4089-4088	474	481	101.5	560	570	101.8
1616-4088	507	525	103.6	344	369	107.3

```

Correlation Coefficient : In 1.000 Out 1.000 Both 1.000

```

TURNON terminated successfully

Evening Peak Period

```

+-----+
| TRACKS - 06-Mar-09 @ 09:29:30                                     |
|                                                                 |
|                                                                 |
|                                                                 |
+-----+

```

```

                                     Gabites Porter |
                                     Christchurch, N.Z. |
+-----+

```

```

+-----+
| TRACKS TRACKS TRACKS TRACKS TRACKS TRACKS TRACKS TR |
| TRACKS +-----+ TRACKS |
| S TRACKS| |S TRACKS |
| KS TRACK| Program :   TURNON |KS TRACK |
| CKS TRAC| Version :   V7.01 |CKS TRAC |
| ACKS TRA| |ACKS TRA |
| RACKS TR| Date run : 06-Mar-09 |RACKS TR |
| TRACKS T| Time run : 09:29:30 |TRACKS T |
| TRACKS | Platform : Win 95/NT | TRACKS |
| S TRACKS+-----+S TRACKS |
| KS TRACKS TRACKS TRACKS TRACKS TRACKS TRACKS |
+-----+
|
| TRACKS Licenced to
| Gabites Porter
| at : Christchurch, N.Z.
|
+-----+

```

```

Build Date : 30/04/08 01:30
Parameter version : V5.20

```

Loaded Network : HE09NL.EXD

```

Intersection Number : 1
Description : IRONGATE RD AND MARAEKAKAHO RD
Number of incoming links : 3
Count Factor : 1.0000
Volume Factor : 1.0000

```

```

3032 | 1580 | 1612 | 1581 |
+-----+
1580 | 0 0 | 313 316 | 16 6 | MARAEKAKAHO RD STH
1612 | 324 306 | 0 0 | 22 28 | MARAEKAKAHO RD NTH
1581 | 14 15 | 33 49 | 0 0 | IRONGATE RD

```

```

Correlation Coefficient : .998
% RMS : 9.141

```

Node	In			Out		
	Count	Volume	%Change	Count	Volume	%Change
1580-3032	329	322	97.9	338	321	95.0
1612-3032	346	334	96.5	346	365	105.5
1581-3032	47	64	136.2	38	34	89.5

```

Correlation Coefficient : In Out Both
                        : 1.000 .999 .999

```

```

Intersection Number : 2
Description : YORK RD AND MARAEKAKAHO RD
Number of incoming links : 3
Count Factor : 1.0000
Volume Factor : 1.0000

```

```

4088 | 1630 | 4089 | 1616 |
+-----+
1630 | 0 0 | 191 217 | 179 120 | MARAEKAKAHO RD STH
4089 | 171 197 | 0 0 | 271 347 | MARAEKAKAHO RD NTH
1616 | 153 130 | 246 286 | 0 0 | YORK RD

```

```

Correlation Coefficient : .988
% RMS : 14.302

```

Node	In			Out		
	Count	Volume	%Change	Count	Volume	%Change
1630-4088	370	337	91.1	324	327	100.9
4089-4088	442	544	123.1	437	503	115.1
1616-4088	399	416	104.3	450	467	103.8

```

Correlation Coefficient : In Out Both
                        : .996 .993 .998

```

TURNON terminated successfully

APPENDIX 3
2009 Validated Base Model: Existing Irongate LU Only

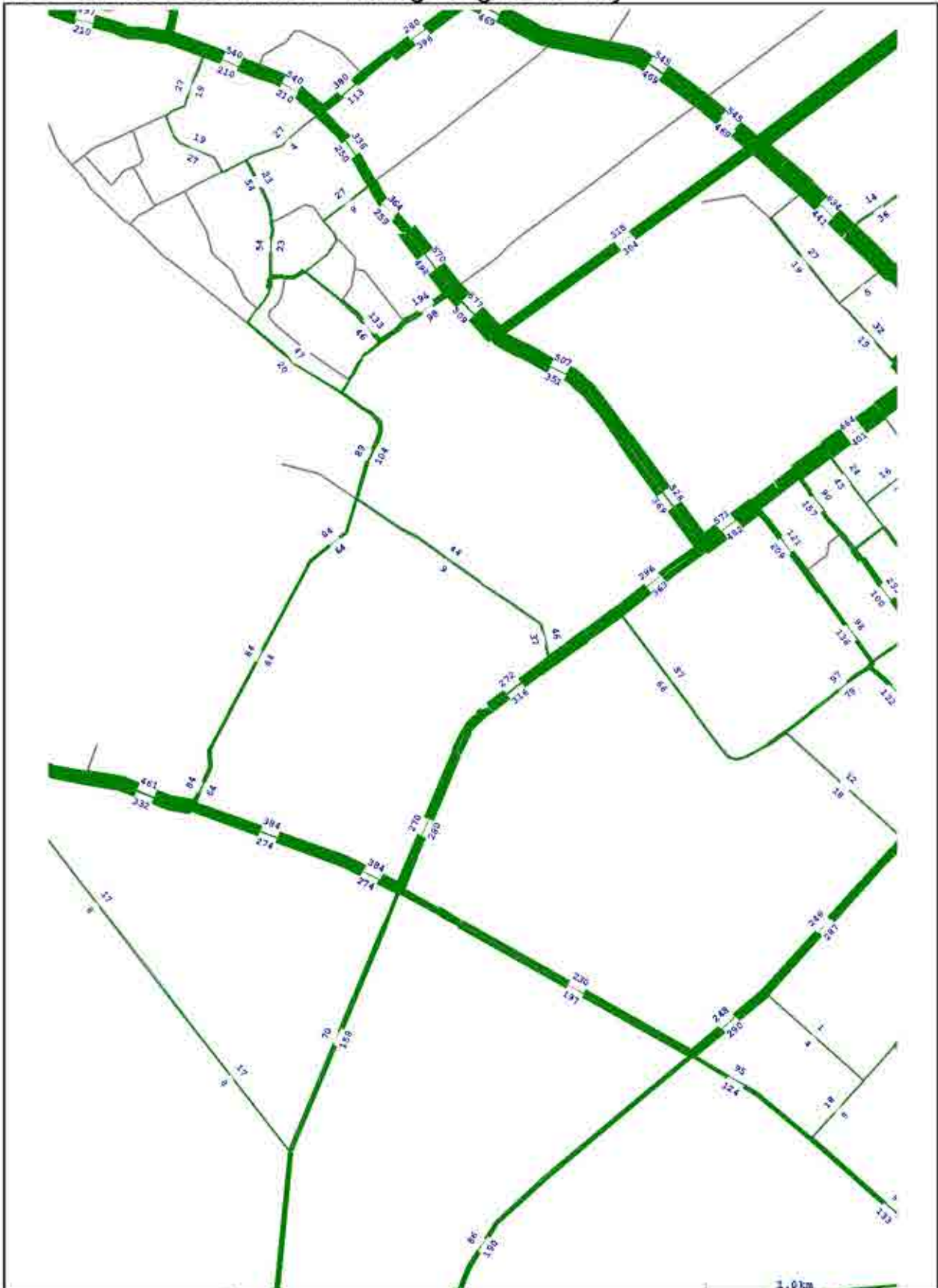

Hawke's Bay Irongate Modelling	2009 AM Peak Validated Base Traffic Volumes	App 3 - 1
Gabites Porter Consultants		

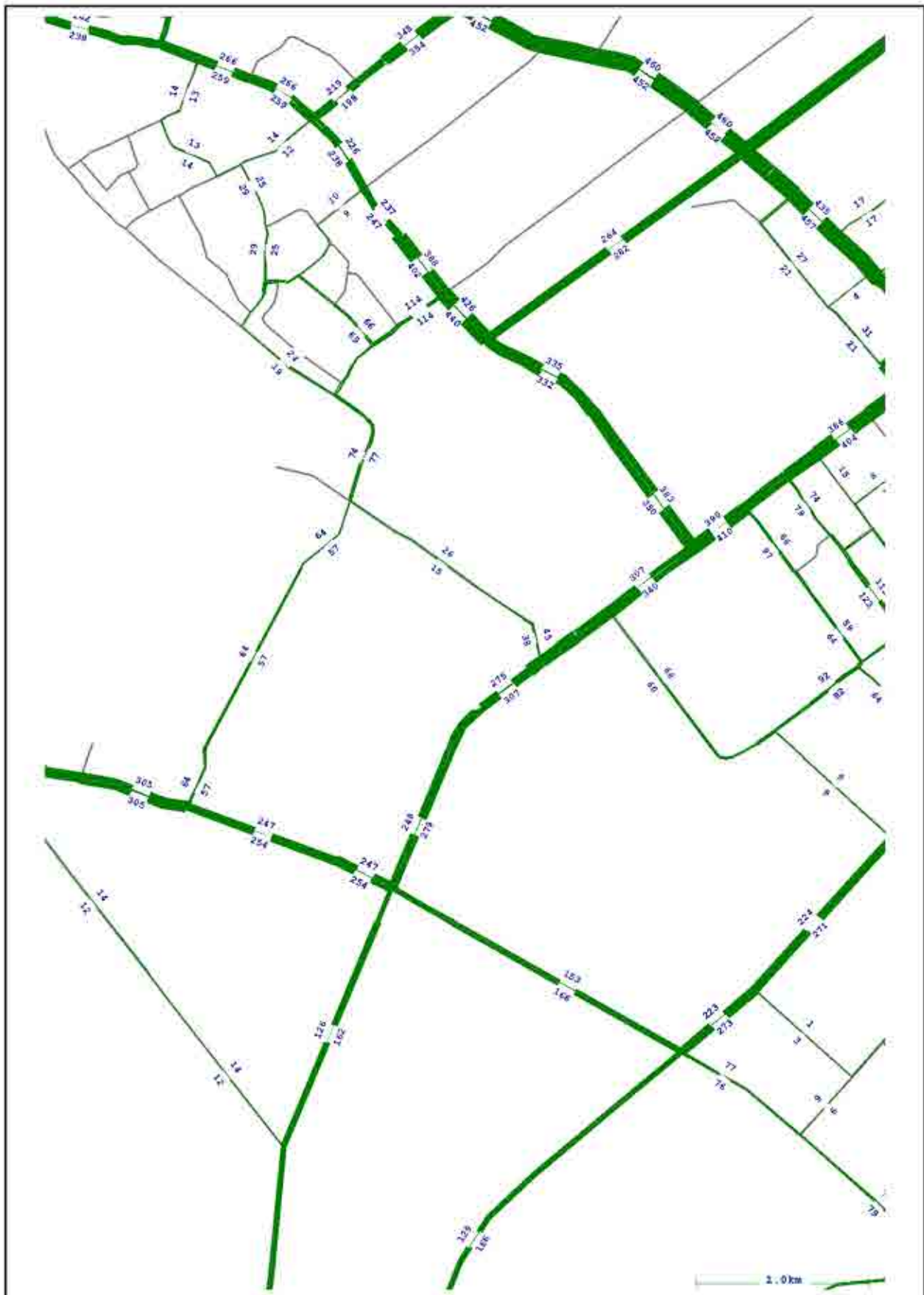

Hawke's Bay Irongate Modelling	2009 SH Peak Validated Base Traffic Volumes	App 3 - 2
Gabites Porter Consultants		

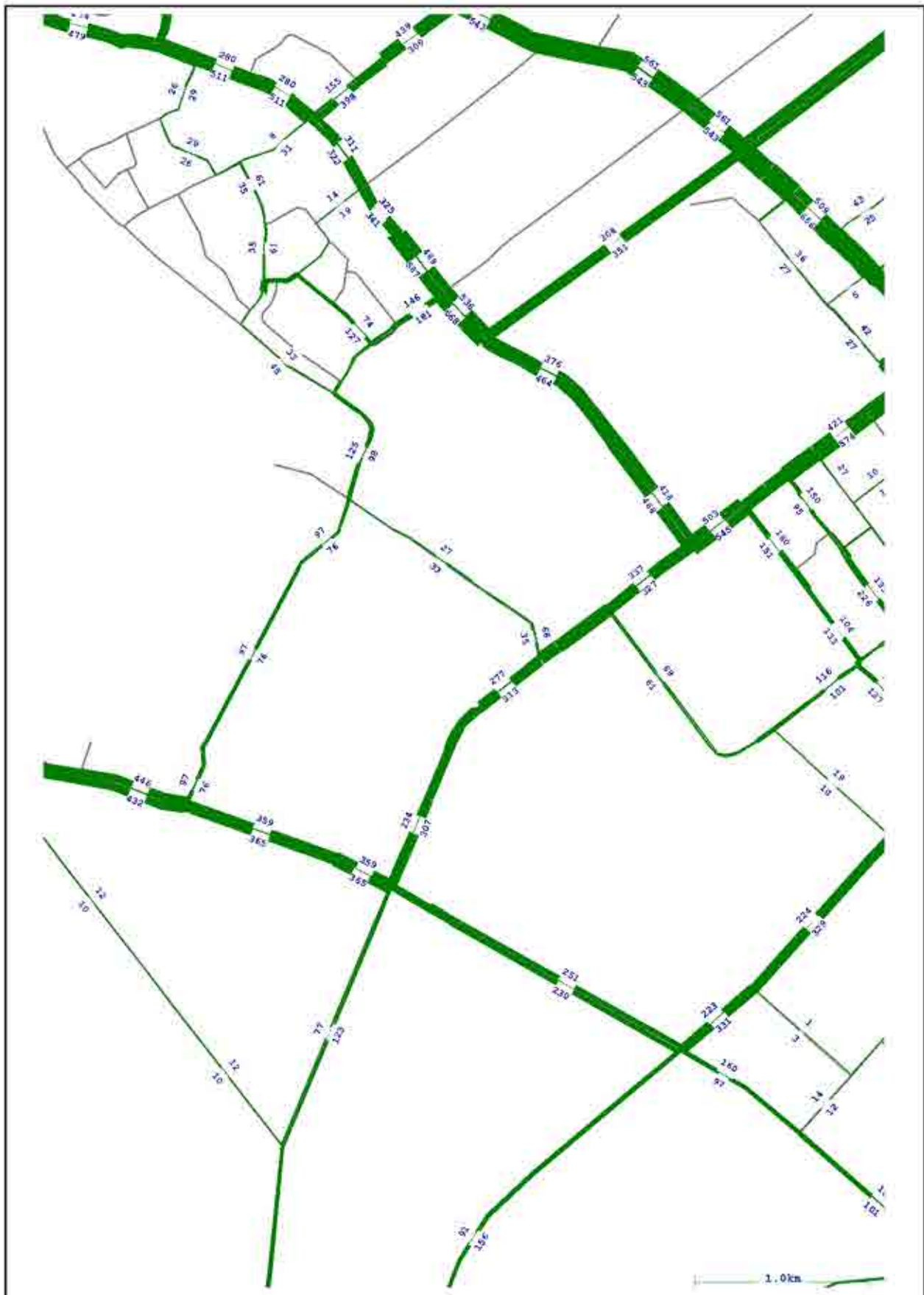

Hawke's Bay Irongate Modelling	2009 PM Peak Validated Base Traffic Volumes	App 3 - 3
Gabites Porter Consultants		

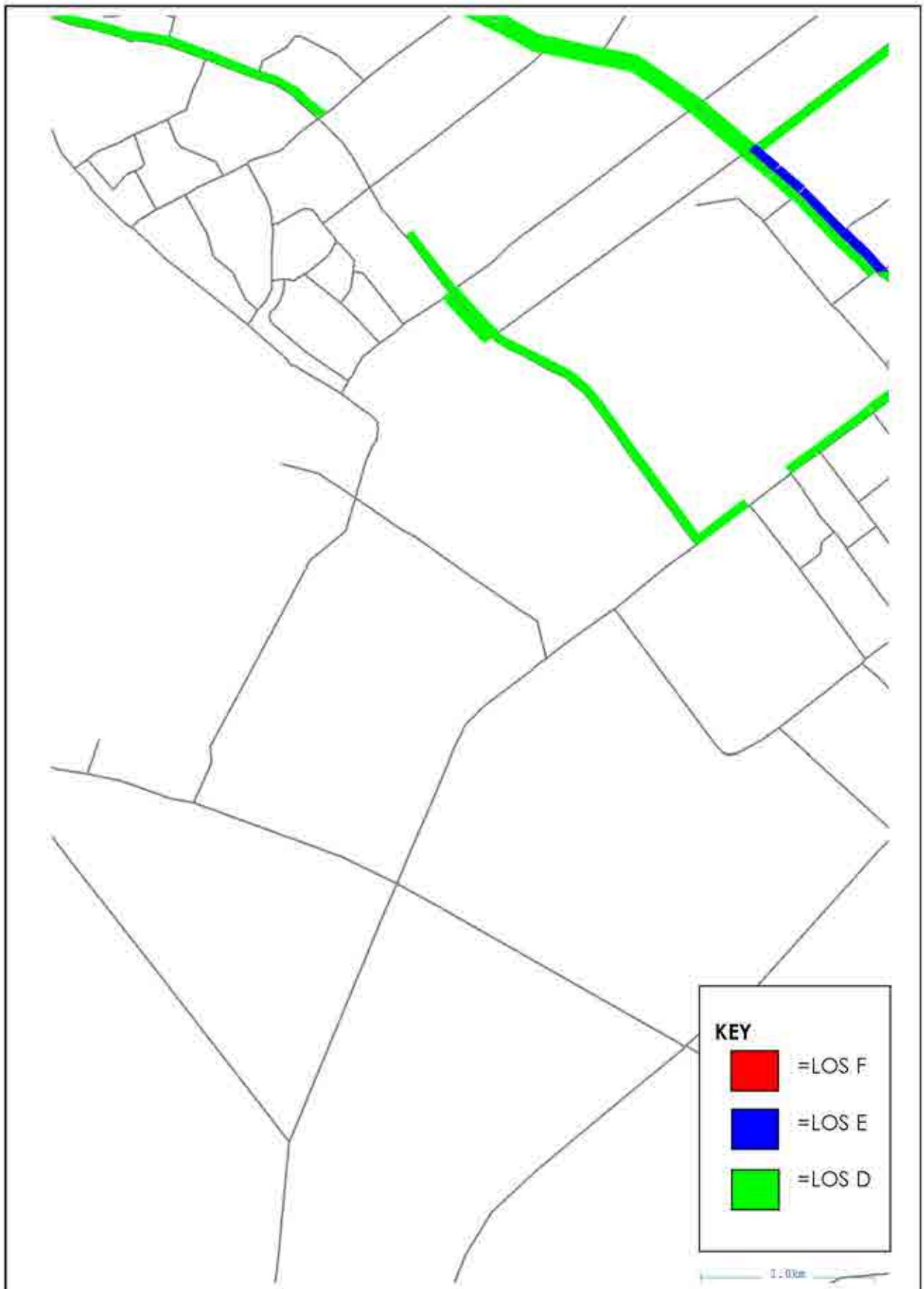

Hawke's Bay Irongate Modelling	2009 AM Peak Validated Base Level of Service	App 3 - 4
Gabites Porter Consultants		

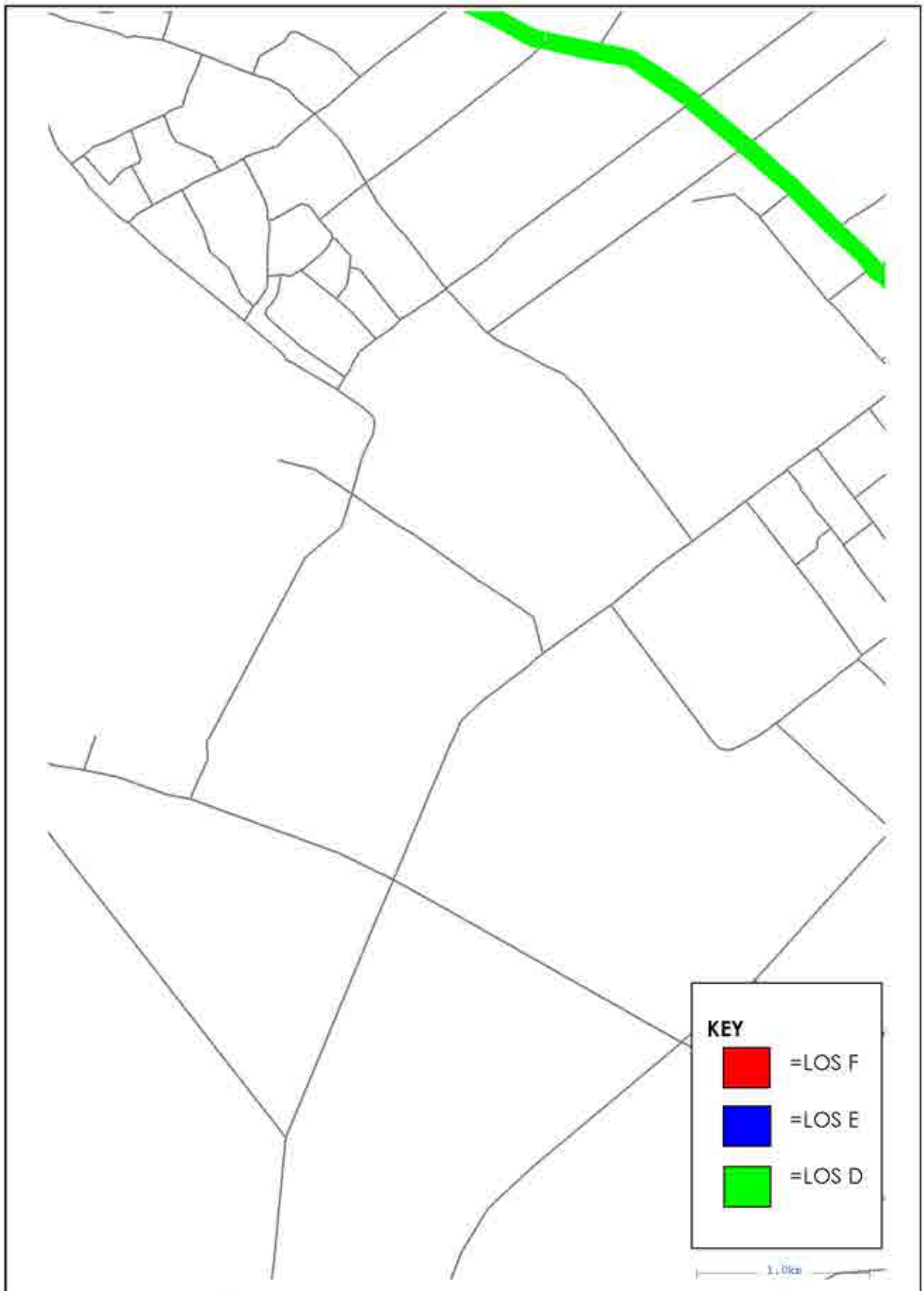

Hawke's Bay Irongate Modelling	2009 SH Peak Validated Base Level of Service	App 3 - 5
Gabites Porter Consultants		

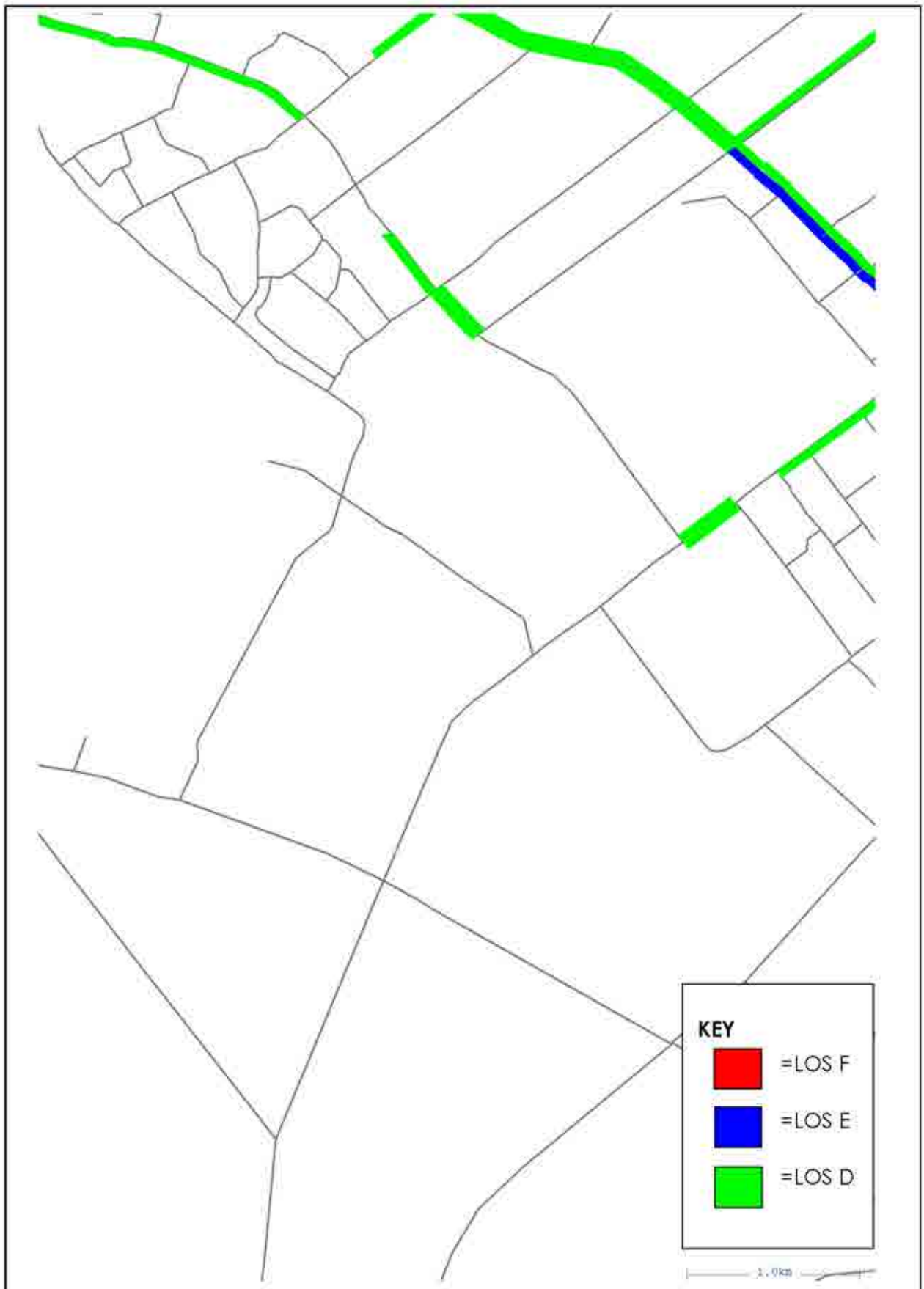

Hawke's Bay Irongate Modelling	2009 PM Peak Validated Base Level of Service	App 3 - 6
Gabites Porter Consultants		

APPENDIX 4
2016 Base Model: Existing Irongate LU Only

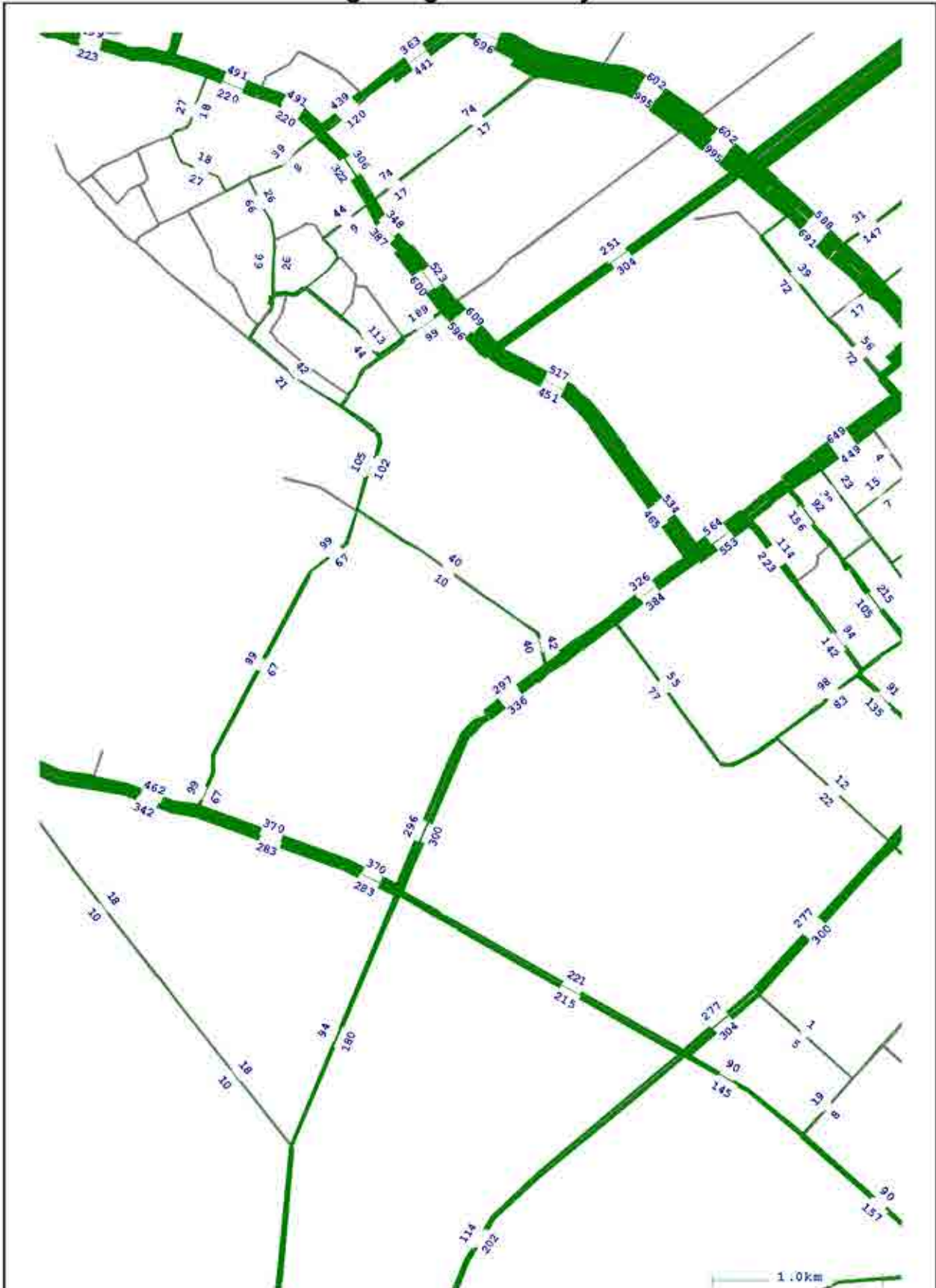

Hawke's Bay Irongate Modelling	2016 AM Peak Base Traffic Volumes	App 4 - 1
Gabites Porter Consultants		

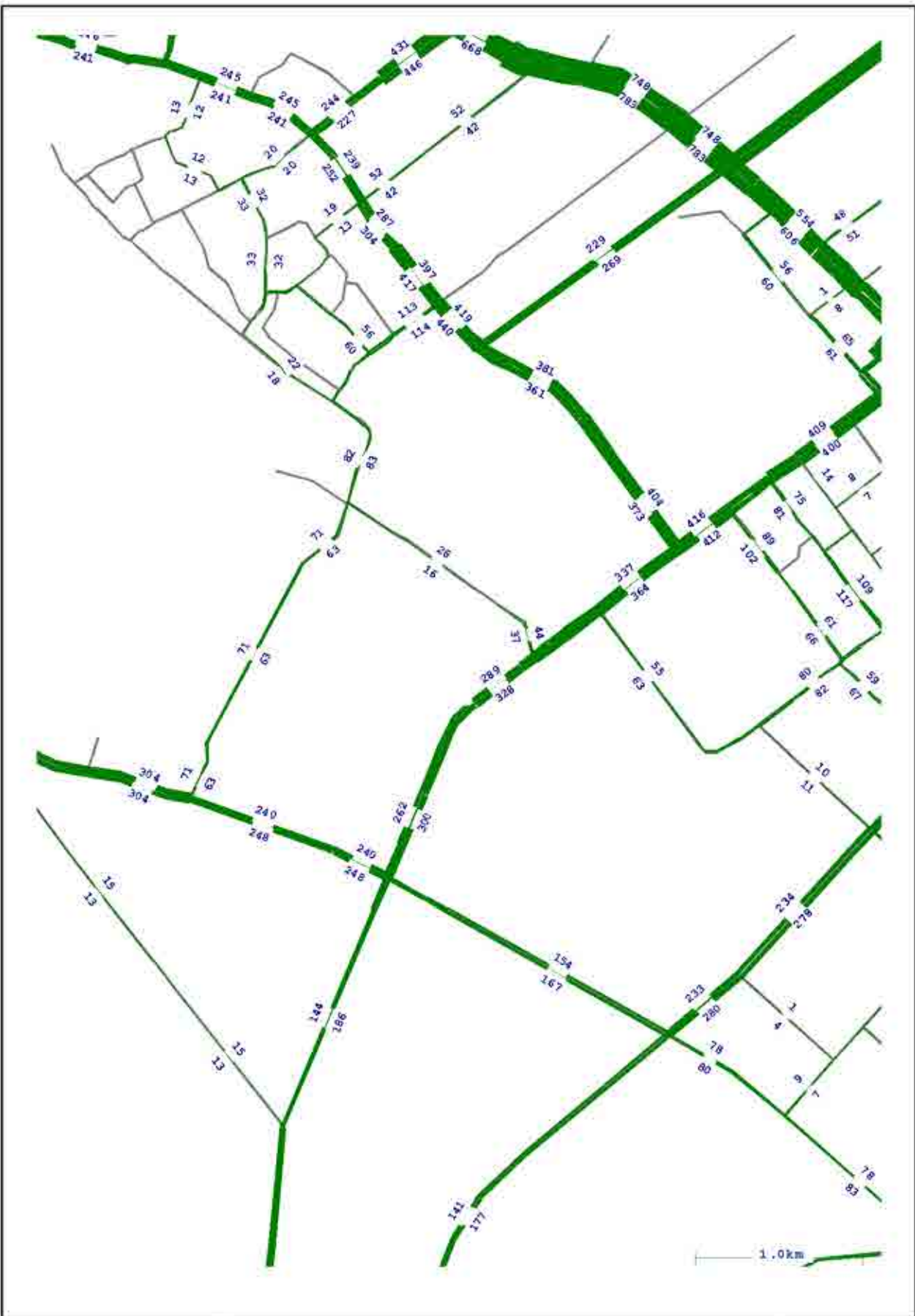

Hawke's Bay Inrrogate Modelling	2016 SH Peak Base Traffic Volumes	App 4 - 2
Gabites Porter Consultants		

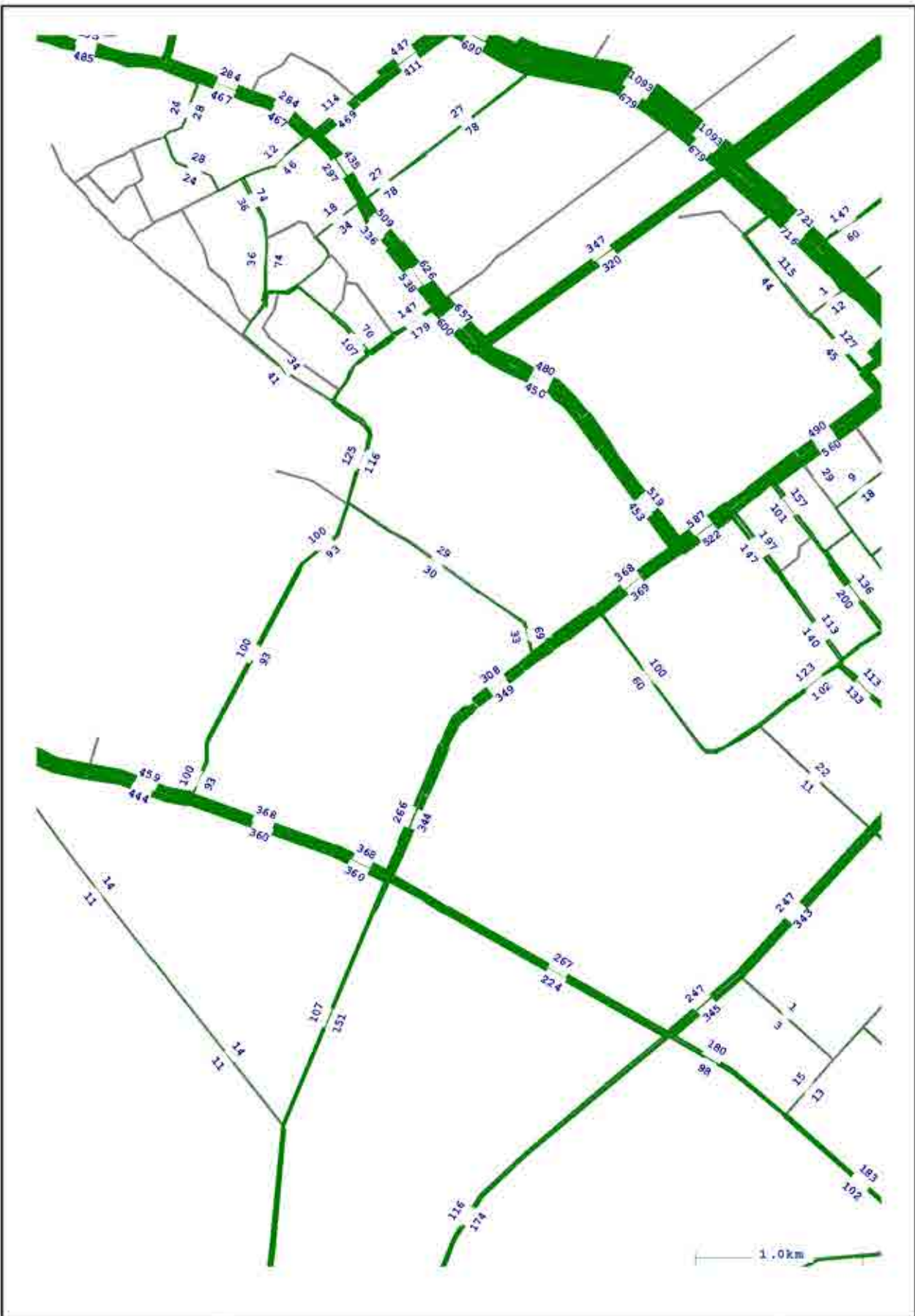

Hawke's Bay Irongate Modelling	2016 PM Peak Base Traffic Volumes	App 4 - 3
Gabites Porter Consultants		

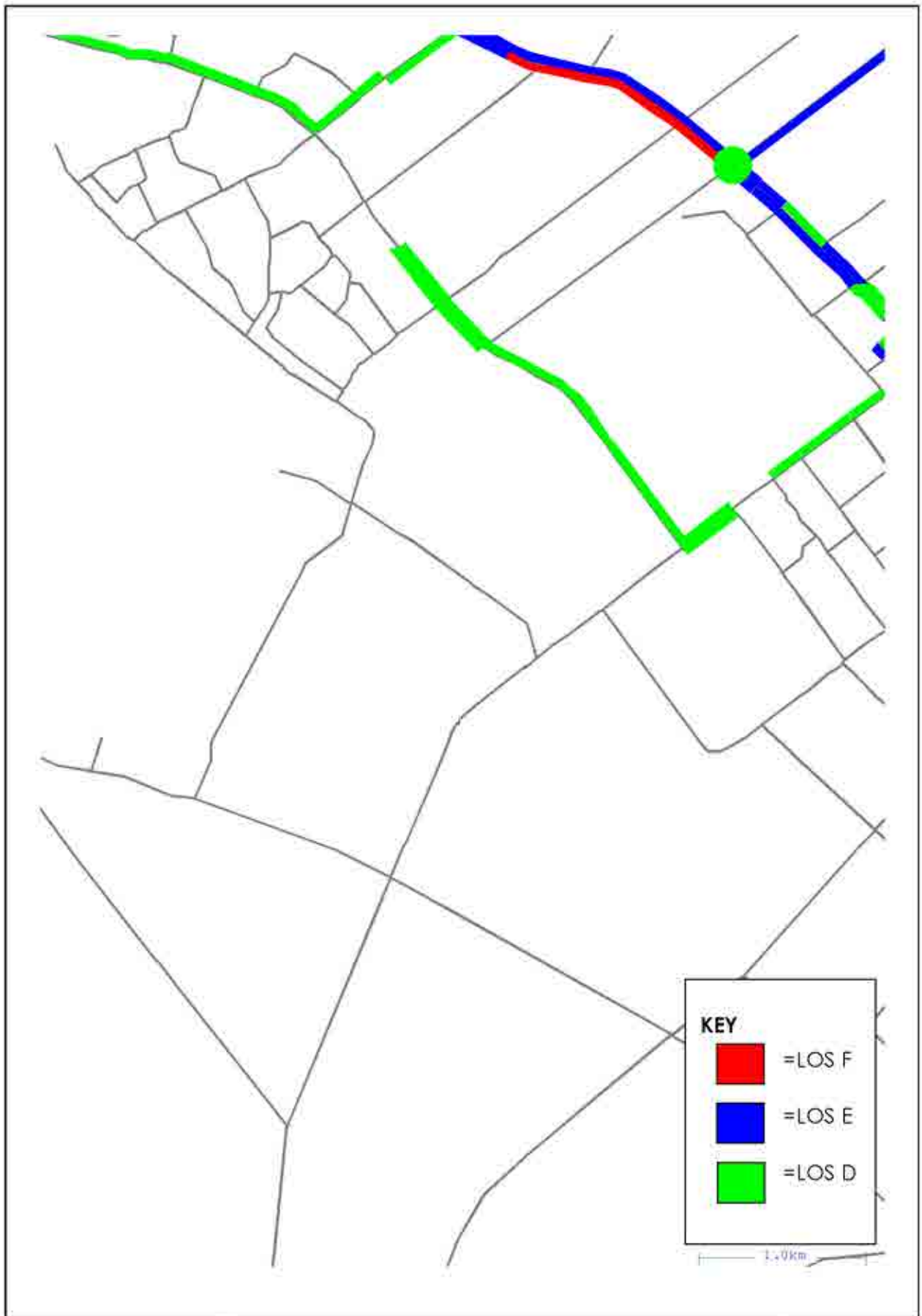

Hawke's Bay Irongate Modelling	2016 AM Peak Base Level of Service	App 4 - 4
Gabites Porter Consultants		

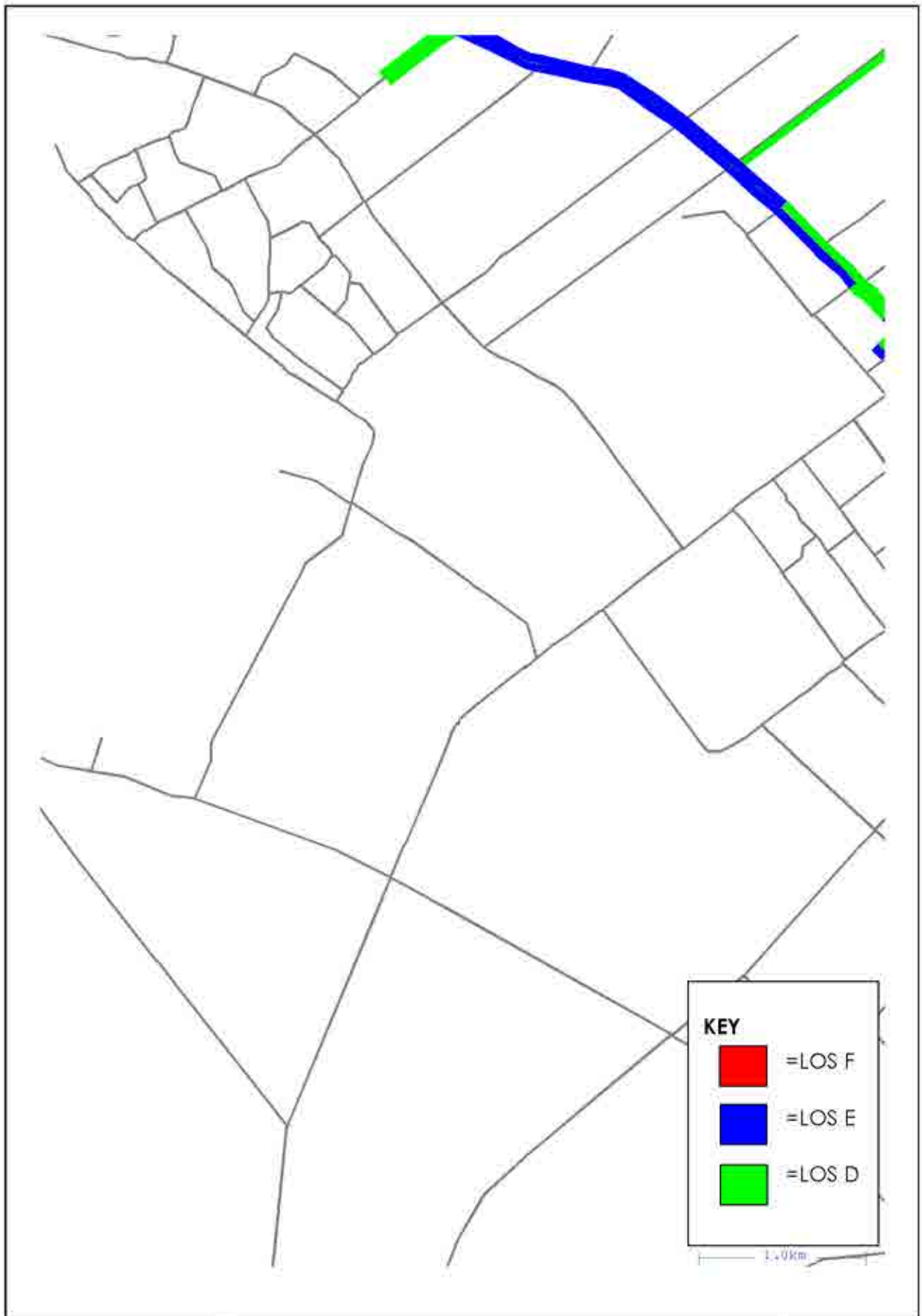

Hawke's Bay Irongate Modelling	2016 SH Peak Base Level of Service	App 4 - 5
Gabites Porter Consultants		

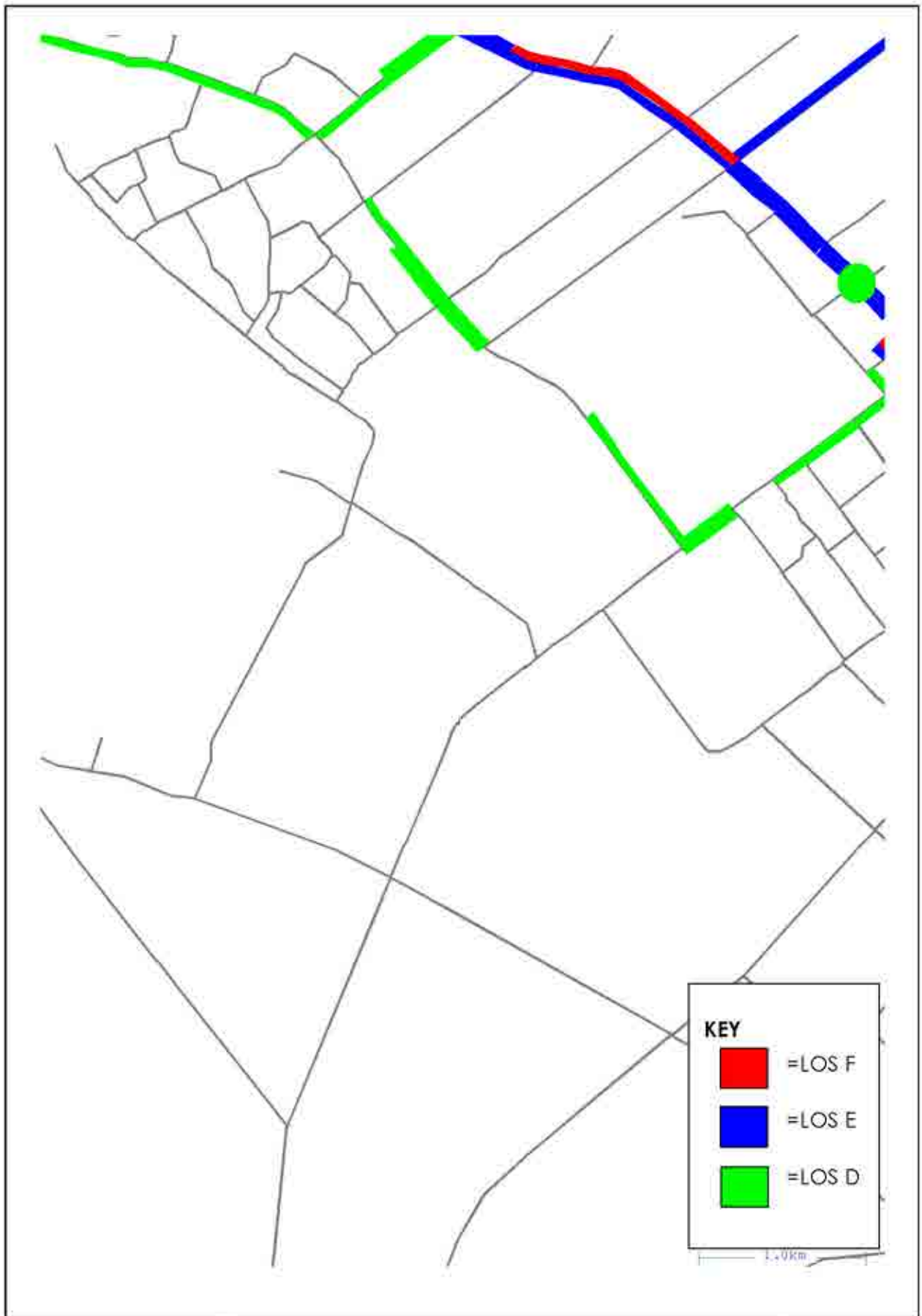

Hawke's Bay Irongate Modelling	2016 PM Peak Base Level of Service	App 4 - 6
Gabites Porter Consultants		

APPENDIX 5
2016 Future Model: Existing Irongate LU Only

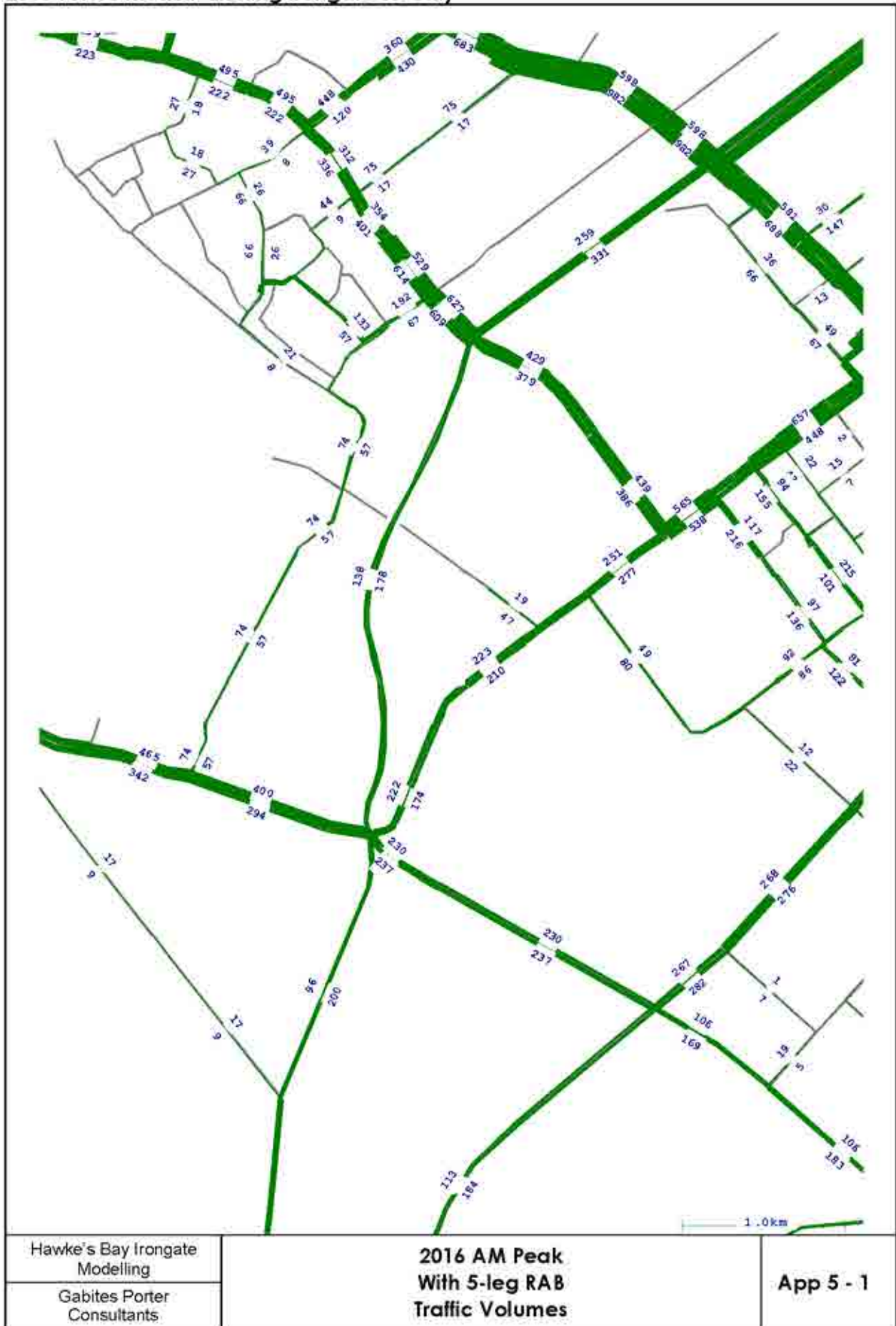

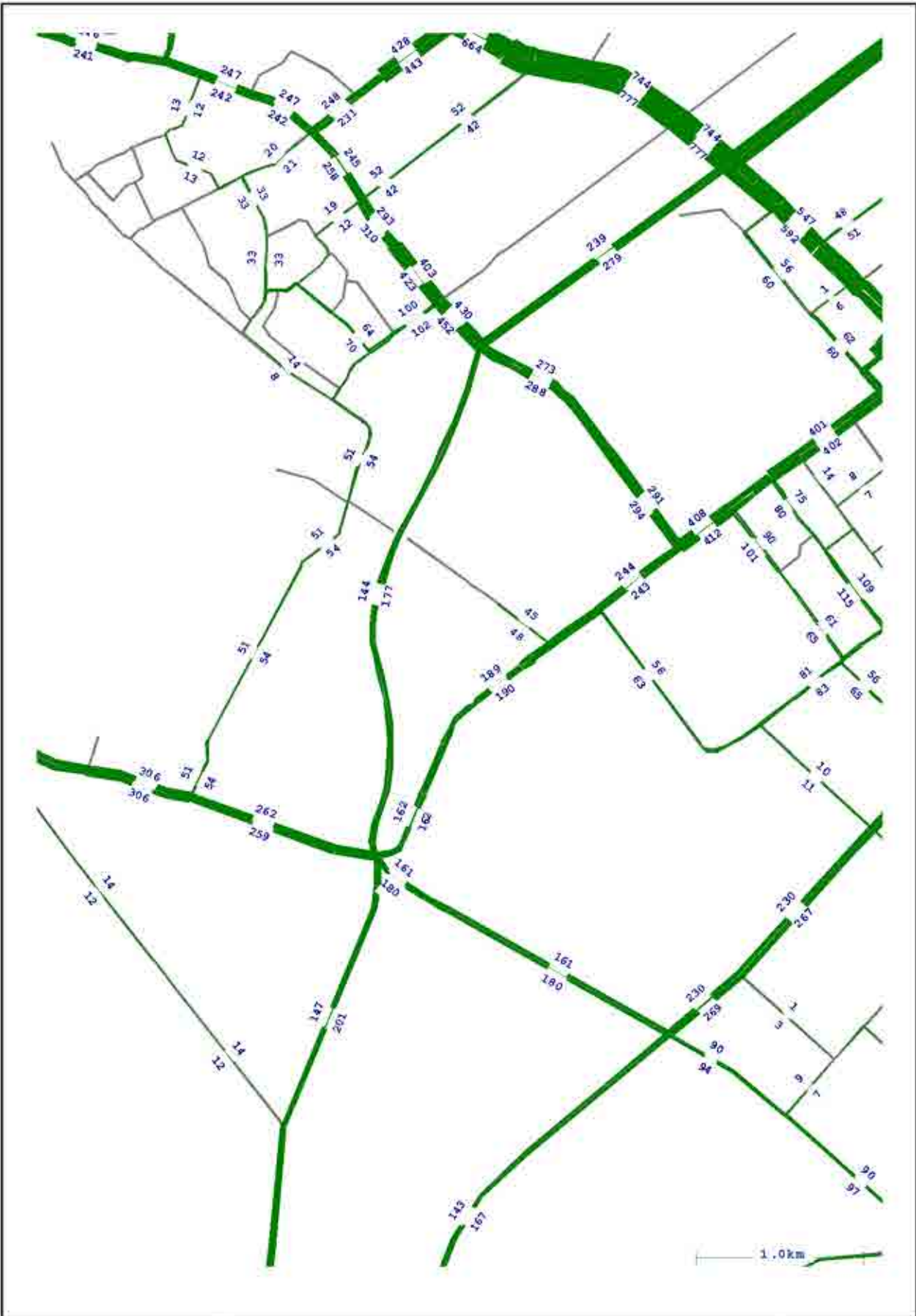

Hawke's Bay Inrongoate Modelling	2016 SH Peak With 5-leg RAB Traffic Volumes	App 5 - 3
Gabites Porter Consultants		

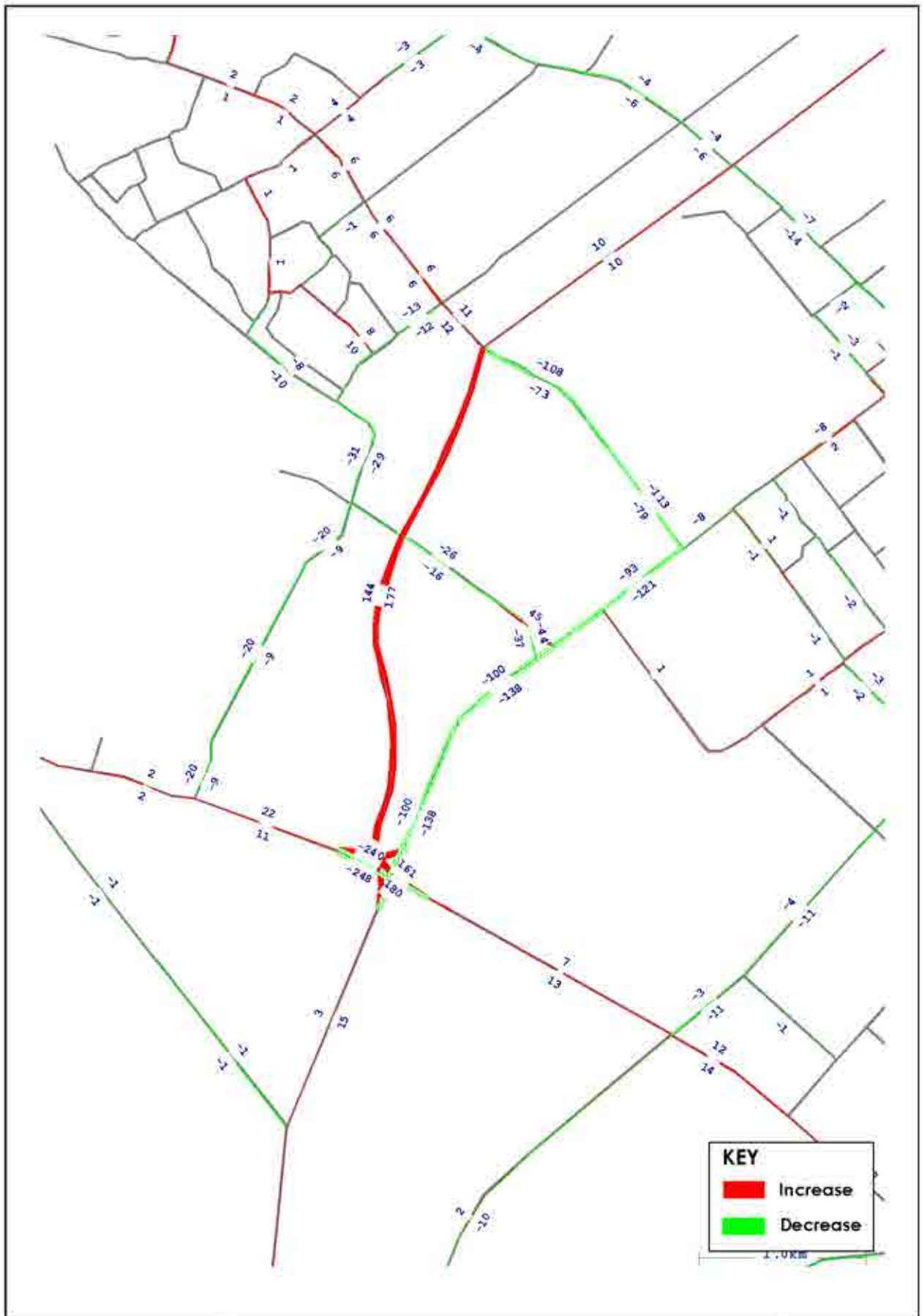

Hawke's Bay Irongate Modelling	2016 SH Peak With 5-leg RAB Traffic Volumes Change to Base	App 5 - 4
Gabites Porter Consultants		

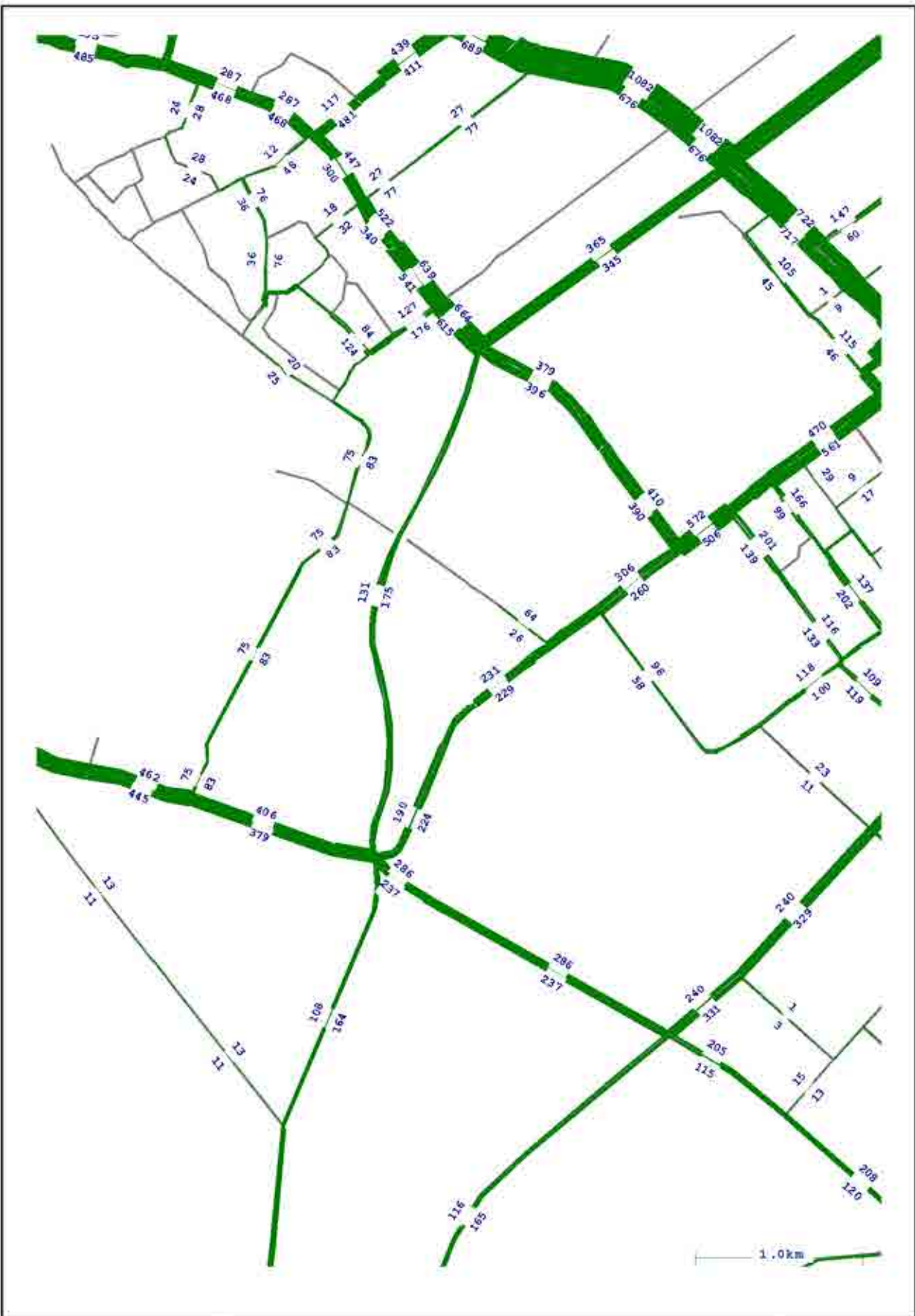

Hawke's Bay Inrgate Modelling	2016 PM Peak With 5-leg RAB Traffic Volumes	App 5 - 5
Gabites Porter Consultants		

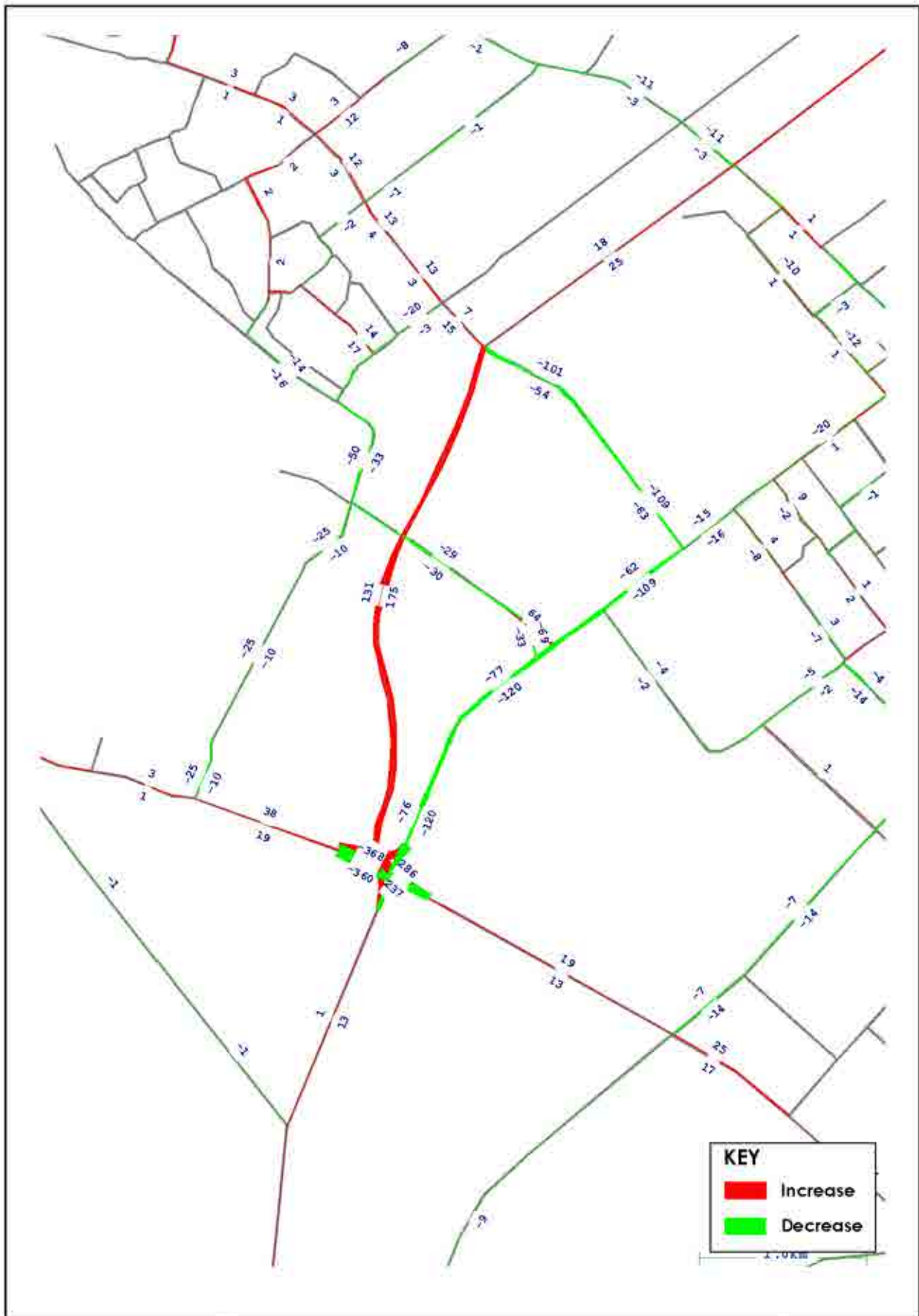

Hawke's Bay Irongate Modelling	2016 PM Peak With 5-leg RAB Traffic Volumes Change to Base	App 5 - 6
Gabites Porter Consultants		

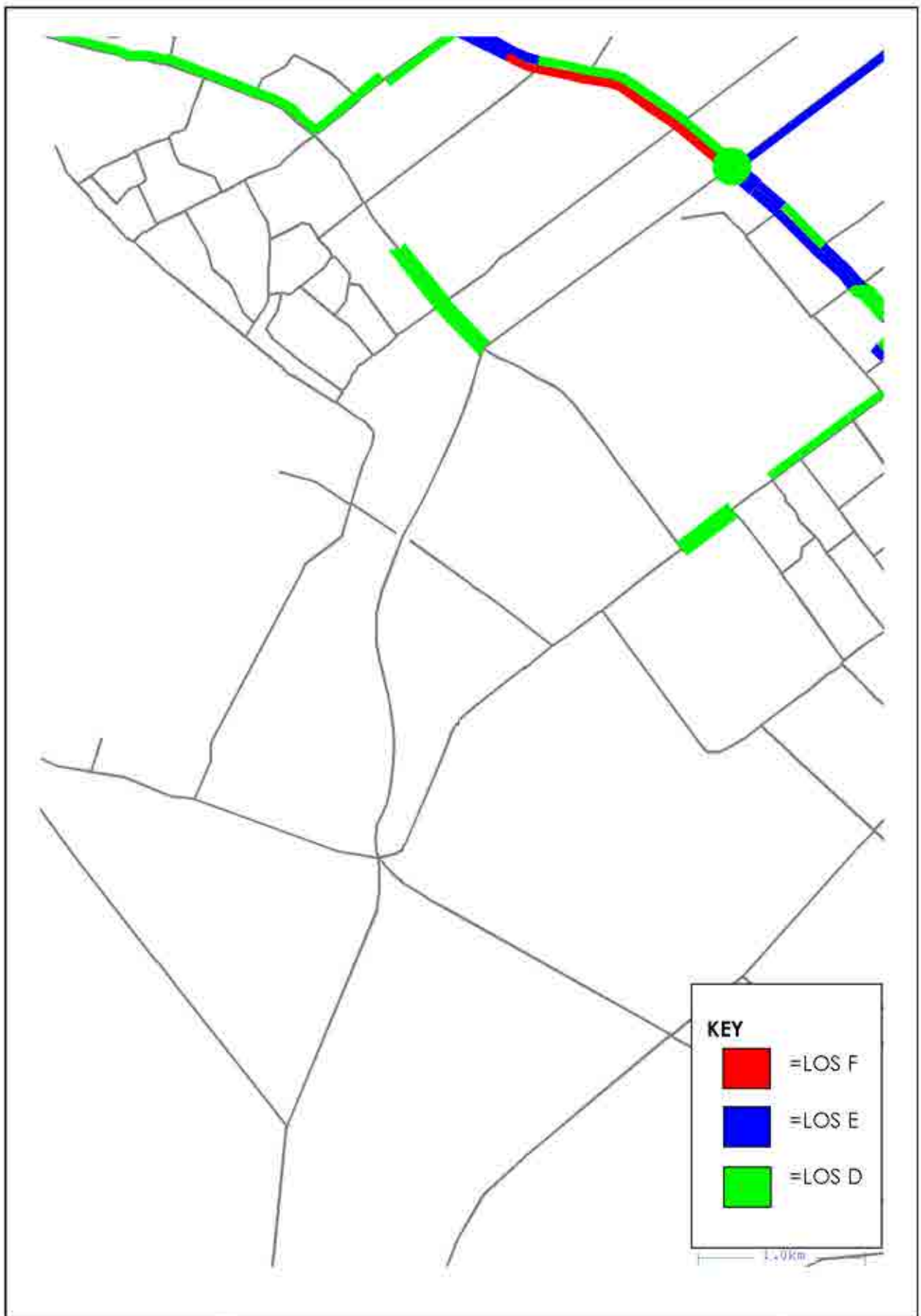

Hawke's Bay Irongate Modelling	2016 AM Peak With 5-leg RAB Level of Service	App 5 - 7
Gabites Porter Consultants		

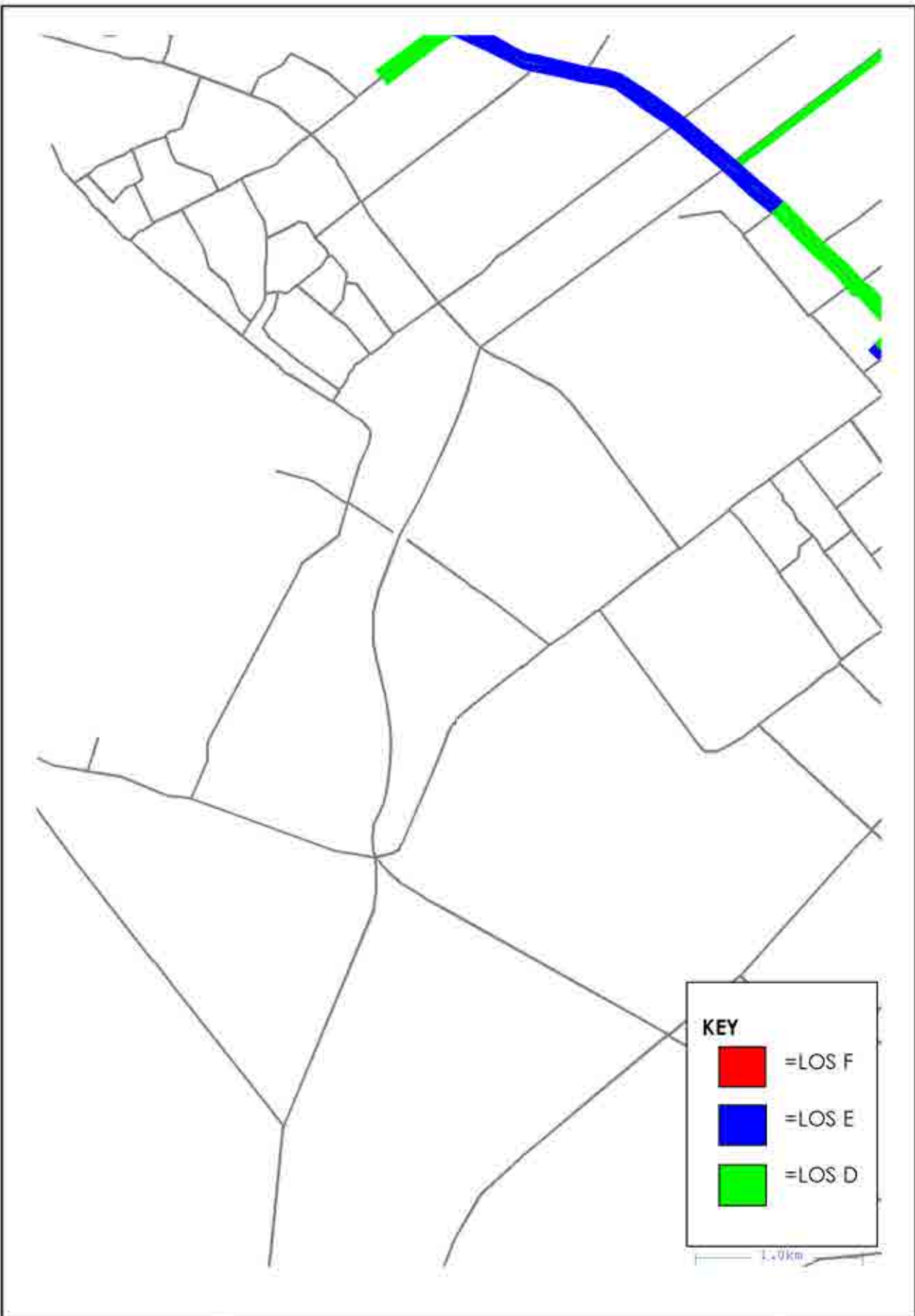

Hawke's Bay Irongate Modelling	2016 SH Peak With 5-leg RAB Level of Service	App 5 - 8
Gabites Porter Consultants		

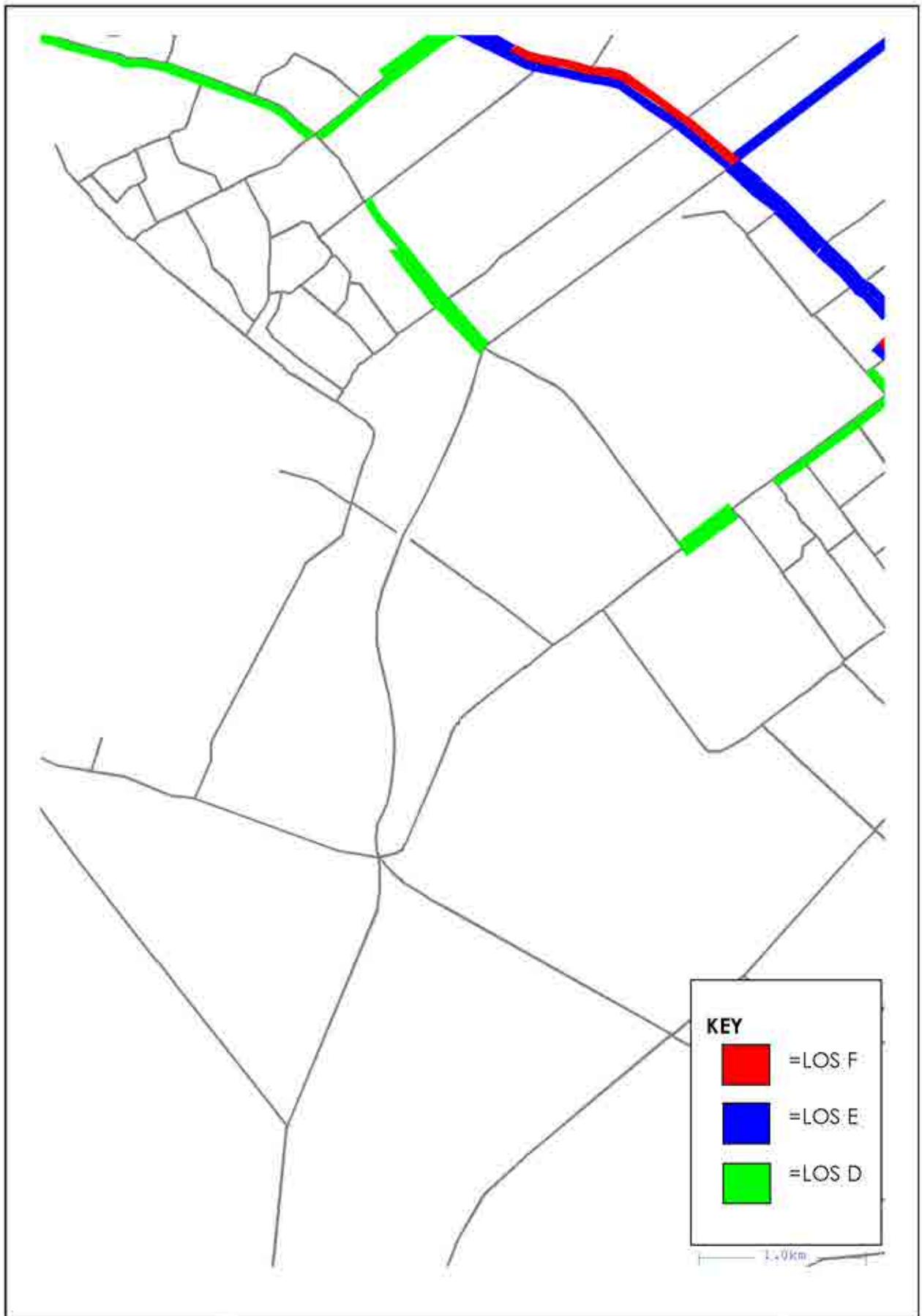

Hawke's Bay Irongate Modelling	2016 PM Peak With 5-leg RAB Level of Service	App 5 - 9
Gabites Porter Consultants		